



IMfinity® 3-phase induction motors

**IE2 High efficiency & IE3 Premium efficiency and
IE4 Super Premium efficiency motors**

Non IE for current or special use

Variable speed and fixed speed

Frame size 56 to 450

Power rating 0.09 to 900 kW

LERROY-SOMER™

Electro_Motor.ir **Nidec**

All for dreams

Contents

GENERAL	5	ELECTRICAL AND MECHANICAL CHARACTERISTICS	58
GENERAL INFORMATION	6	Non IE efficiency - Powered by the mains	58
Quality commitment.....	6	IE2 - Powered by the drive	62
Directive and standards relating to motor efficiency	7	IE3 - Powered by the mains	63
Standards and approvals	8	IE3 - Powered by the drive	65
Definition of «Index of protection» (IP)	11	Mains connection.....	66
Environmental limitations	12	DIMENSIONS	67
Impregnation and enhanced protection.....	13	Shaft extensions	67
Heaters	14	Foot mounted IM 1001 (IM B3).....	68
External finish	15	Foot and flange IM 2001 (IM B35).....	69
Interference suppression and protection of people	16	Flange mounted IM 3001 (IM B5) IM 3011 (IM V1).....	70
CONSTRUCTION	17	Foot and face IM 2101 (IM B34).....	71
Mounting arrangements.....	17	Face mounted IM 3601 (IM B14).....	72
Mains connection.....	18	CONSTRUCTION	73
Radial loads	19	Bearings and lubrication	73
Cooling	20	Axial loads	75
Cooling for LSES/FLSES/PLSES motors.....	22	Radial loads	78
Motor connections	23	OPTIONAL FEATURES	85
Bearings and bearing life	24	Non-standard flanges	85
Lubrication and maintenance of bearings	25	Mechanical options.....	86
OPERATION	26	Mechanical and electrical options	87
Duty cycle - Definitions.....	26	INSTALLATION AND MAINTENANCE	88
Supply voltage	29	Position of the lifting rings	88
Insulation class - Temperature rise and thermal reserve	31	IP55 CAST IRON FRAME	89
Starting times and starting current	32	GENERAL INFORMATION	89
Power - Torque - Efficiency - Power Factor (Cos φ).....	33	Designation.....	89
Use with speed drive.....	36	Description.....	90
Noise level	39	ELECTRICAL AND MECHANICAL CHARACTERISTICS	91
Weighted sound level [dB(A)].....	40	IE2 - Powered by the mains	91
Vibration	41	IE2 - Powered by the drive	93
Optimised performance	43	IE3 - Powered by the mains	94
Starting methods for induction motors.....	44	IE4 - Powered by the mains	97
Braking	48	Mains connection.....	99
Operation as an asynchronous generator	50	DIMENSIONS	100
ELECTRICAL AND MECHANICAL DATA	52	Shaft extensions	100
Identification	52	Foot mounted IM 1001 (IM B3).....	101
IP55 ALUMINIUM FRAME	56	Foot and flange mounted IM 2001 (IM B35)	102
GENERAL INFORMATION	56	Flange mounted IM 3001 (IM B5) IM 3011 (IM V1).....	103
Designation.....	56	Foot and face mounted IM 2101 (IM B34)	104
Description.....	57	Face mounted IM 3601 (IM B14).....	105

Contents

CONSTRUCTION.....	106	APPENDIX.....	145
Bearings and lubrication	106	Cable gland support plates	145
Axial loads	108	Calculating the efficiency of an induction motor	146
Radial loads	111	Units of measurement and standard formulae	147
OPTIONAL FEATURES.....	118	Unit conversions	150
Non-standard flanges	118	Standard formulae used in electrical engineering	151
Mechanical options	119	Tolerance on main performance parameters.....	153
Mechanical and electrical options	120	Configurator.....	154
INSTALLATION AND MAINTENANCE.....	121	Declaration of EC conformance	155
Position of the lifting rings	121		
IP23 STEEL FRAME	122		
GENERAL INFORMATION	122		
Designation.....	122		
Description.....	123		
ELECTRICAL AND MECHANICAL CHARACTERISTICS ...	124		
IE2 - Powered by the mains	124		
IE2 - Powered by the drive	125		
IE3 - Powered by the mains	126		
Mains connection.....	129		
DIMENSIONS.....	130		
Shaft extensions	130		
Foot mounted IM 1001 (IM B3).....	131		
Foot and flange mounted IM 2001 (IM B35)	132		
Flange mounted IM 3001 (IM B5) IM 3011 (IM V1)	133		
CONSTRUCTION.....	134		
Bearings and lubrication	134		
Axial loads	135		
Radial loads	138		
OPTIONAL FEATURES	143		
Mechanical options	143		
INSTALLATION AND MAINTENANCE.....	144		
Position of the lifting rings	144		

Electro_Motor.ir

Index

A		M	
Ambient temperature	7	Marking	9, 16, 52, 87
Approvals	8	N	
Availability	154	Nameplates	16, 17, 52, 74, 106, 133
B		Noise	39, 58, 60, 63, 91
Balancing	41	O	
C		Operating position	12, 40
Configurator	154	P	
Conformance	9, 36, 155	Performance	29, 43, 52, 146, 153
Connection	16, 18, 23, 38, 44, 48, 49, 51, 66, 90	Power	12, 16, 34
CSA	9	Power Factor	33, 34, 35
D		Q	
Direction of rotation	8, 21, 34, 40, 48, 66, 98, 122, 128	Quality assurance	6
Drain holes	12	S	
Drip covers	12	Serial number	52
E		Speed of rotation	24, 33, 48, 49, 73, 105, 151
Earth terminal	18, 57, 90, 122	Standards	7, 8, 9
Efficiency	5, 7, 8, 9, 29	Starting time	32, 34, 35, 44
Energy regulations	9	Supply voltage	29, 30, 66, 98, 128
Environment 6, 8, 11, 12, 13, 14, 15, 16, 20, 31, 39, 44, 74, 106, 133, 144		T	
External finish	15, 90	Temperature rise	31
F		Terminal blocks	66, 98, 128
Flange 17, 69, 70, 72, 74, 85, 86, 87, 101, 102, 117, 118, 119, 131, 132, 142		Terminal box	18
Forced ventilation	13, 87, 119	Thermal protection	43
H		Thermal reserve	31
Heaters	14, 87, 119, 142	Tolerance	153
Humidity	8, 12, 13, 31	Torque	33, 34
I		V	
Impregnation	10, 12, 13, 31, 52	Vibration	41, 42, 148
Index of protection	11		
Installation	88, 120, 143		
Insulation class	31		
Interference suppression	16		
K			
Key	41, 57, 90, 122, 153		
L			
Lifting rings	88, 120, 143		
Locked rotor times	32		
Lubrication	25, 73, 74, 105, 106, 133		

IMfinity® 3-phase induction motors - IE2 - IE3 - IE4 - Non IE Efficiency General

In this catalogue, Nidec Leroy-Somer describes the IMfinity® new generation induction motors.

These motors have been designed to incorporate the latest European

standards, and can satisfy most of industry's demands.

They are par excellence the leading products in the Nidec Leroy-Somer range.

Other motors, ranging in power from **0.045 to 2200 kW** and special construction types, are included in the Nidec Leroy-Somer motor programme.

IP55 ALUMINIUM MOTORS



NON IE EFFICIENCY

IP 55 ALUMINIUM ON MAINS*

HIGH EFFICIENCY

IE2 IP55 ALUMINIUM ON MAINS*

IE2 IP55 ALUMINIUM ON DRIVE

PREMIUM EFFICIENCY

IE3 IP55 ALUMINIUM ON MAINS

IE3 IP55 ALUMINIUM ON DRIVE

IP55 CAST IRON MOTORS



HIGH EFFICIENCY

IE2 IP 55 CAST IRON ON MAINS*

IE2 CAST IRON ON DRIVE

PREMIUM EFFICIENCY

IE3 IP55 CAST IRON ON MAINS

IE3 CAST IRON ON DRIVE

SUPER PREMIUM EFFICIENCY

IE4 IP55 CAST IRON ON MAINS

IE4 CAST IRON ON DRIVE

IP23 DRIP-PROOF MOTORS



HIGH EFFICIENCY

IE2 IP23 PROTECTED ON MAINS*

IE2 IP23 PROTECTED ON DRIVE

PREMIUM EFFICIENCY

IE3 IP23 PROTECTED ON MAINS

IE3 IP23 PROTECTED ON DRIVE

Electro_Motor.ir

For more information, see the "Directives and standards relating to motor efficiency" section.

* Use outside the European Union

General General information Quality commitment

Nidec Leroy-Somer's quality management system is based on:

- Control of procedures right from the initial sales offering until delivery to the customer, including design, manufacturing start-up and production
- A total quality policy based on making continuous progress in improving operational procedures, involving all departments in the company in order to give customer satisfaction as regards delivery times, conformity and cost
- Indicators used to monitor procedure performance
- Corrective actions and advancements with tools such as FMECA, QFD, MAVP, MSP/MSQ and Hoshin type improvement workshops on flows, process re-engineering, plus Lean Manufacturing and

Lean Office

- Annual surveys, opinion polls and regular visits to customers in order to ascertain and detect their expectations.

Personnel are trained and take part in analyses and actions for continuous improvement of our procedures.

- The motors in this catalogue have been specially designed to measure the impact of their life cycle on the environment. This eco-design approach has resulted in the creation of a "Product Environmental Profile" (references 4592/4950/4951).



Nidec Leroy-Somer has entrusted the certification of its expertise to various international organisations.

Certification is granted by independent professional auditors, and recognises the high standards of the **company's quality assurance procedures**. All activities resulting in the final version of the machine have therefore received official certification **ISO 9001: 2015 from the DNV**. Similarly, our environmental approach has enabled us to obtain certification ISO 14001: 2015.

Products for particular applications or those designed to operate in specific environments are also approved or certified by the following organisations: LCIE, DNV, INERIS, EFECTIS, UL, BSRIA, TUV, GOST, which check their technical performance against the various standards or recommendations.

ISO 9001 : 2015



General

General information

Directive and standards relating to motor efficiency

There have been a number of changes to the standards and new standards created in recent years. They mainly concern motor efficiency and their scope includes measurement methods and motor classification.

Regulations are gradually being implemented, both nationally and internationally, in many countries in order to promote the use of high-efficiency motors (Europe, USA, Canada, Brazil, Australia, New Zealand, Korea, China, Israel, etc).

The new generation of Premium efficiency three-phase induction motors responds to changes in the standards as well as the latest demands of system integrators and users.

STANDARD IEC 60034-30-1 (March 2014)

It defines the principle to be adopted and brings global harmonisation to energy efficiency classes for electric motors throughout the world.

Motors concerned

Single-speed, single-phase and 3-phase cage induction or permanent magnet motors, on a sinusoidal mains supply.

Sphere of application:

- U_N from 50 to 1000 V
- P_N from 0.12 to 1000 kW
- 2, 4, 6 and 8 poles
- Continuous duty at rated power without exceeding the specified insulation class. Generally known as S1 duty.
- 50 and 60 Hz frequency
- On the mains
- Marked for an ambient temperature between -20°C and +60°C
- Marked for an altitude up to 4000 m

Motors not concerned

- Motors with frequency inverter when the motor cannot be tested without one.
- Brake motors when the brake forms an integral part of the motor and can neither be removed nor supplied by a separate source when being tested.
- Motors which are fully integrated in a machine and cannot be tested separately (such as rotor/stator).

STANDARD FOR MEASURING THE EFFICIENCY OF ELECTRIC MOTORS: IEC 60034-2-1 (June 2014)

It concerns asynchronous induction motors:

- Single-phase and three-phase with power ratings of 1 kW or less. The preferred method is the D.O.L. method.
- Three-phase motors with power ratings above 1 kW. The preferred method is the summation of losses method including the total of additional losses measured.

Notes:

- The standard for efficiency measurement is very similar to the IEEE 112-B method used in North America.
- Since the measurement method is different, this means that for the same motor, the rated value will be different (usually lower) with IEC 60034-2-1 than with the previous version IEC 60034-2.

Example of a 22 kW 4P LSES motor:

- according to IEC 60034-2, the efficiency is 92.6%
- according to IEC 60034-2-1, the efficiency is 92.3%

ErP DIRECTIVE (Energy Related Product) 2009/125/EC (21 October 2009)

It establishes a framework for setting the eco-design requirements to be applied to "energy-using products". These products are grouped in lots. Motors come under lot 11 of the eco-design programme, as do pumps, fans and circulating pumps.

DECREE IMPLEMENTING OF THE ErP EUROPEAN REGULATION (Energy Related Product) EC/640/2009 + AMENDEMENT EU/4/2014

This is based on standard IEC 60034-30-1 and will define the efficiency classes. It specifies the efficiency levels to be attained for machines sold in the European market and outlines the timetable for their implementation.

Efficiency classes	Efficiency level
IE1	Standard
IE2	High
IE3	Premium
IE4	Super Premium

This standard only defines efficiency classes and their conditions. It is then up to each country to define the efficiency classes and the exact scope of application.

Motors concerned:

3-phase motors from 0.75 to 375 kW with 2, 4 and 6 poles.

Obligation to place High efficiency or Premium efficiency motors on the market:

- IE2 class from 16 June 2011
- Class IE3* from 1st January 2015 for power ratings from 7.5 to 375 kW
- Class IE3* from 1st January 2017 for power ratings from 0.75 to 375 kW

** or IE2 motor + drive*

Motors not concerned:

- Motors designed to operate when fully submerged in liquid
- Motors which are fully integrated in another product (rotor/stator)
- Motors with duty other than continuous duty
- Motors designed to operate in the following conditions:
 - altitude > 4000 m
 - ambient air temperature > 60°C
 - maximum operating temperature > 400°C
 - ambient air temperature < -30°C or < 0°C for water-cooled motors
 - safety motors conforming to directive ATEX 94/9/EC
 - brake motors.

Motors comply with the standards
quoted in this catalogue

LIST OF STANDARDS QUOTED IN THIS DOCUMENT

Reference		International standards
IEC 60034-1	EN 60034-1	Electrical rotating machines: ratings and operating characteristics
IEC 60034-2		Electrical rotating machines: methods for determining losses and efficiency from tests (additional losses added as a fixed percentage)
IEC 60034-2-1		Electrical rotating machines: methods for determining losses and efficiency from tests (measured additional losses)
IEC 60034-5	EN 60034-5	Electrical rotating machines: classification of degrees of protection provided by casings of rotating machines
IEC 60034-6	EN 60034-6	Electrical rotating machines (except traction): cooling methods
IEC 60034-7	EN 60034-7	Electrical rotating machines (except traction): symbols for mounting positions and assembly layouts
IEC 60034-8		Electrical rotating machines: terminal markings and direction of rotation
IEC 60034-9	EN 60034-9	Electrical rotating machines: noise limits
IEC 60034-12	EN 60034-12	Starting performance of single-speed three-phase cage induction motors for supply voltages up to and including 660 V.
IEC 60034-14	EN 60034-14	Electrical rotating machines: mechanical vibration of certain machines with shaft heights 56 mm and higher. Measurement, evaluation and limits of vibrational intensity
IEC 60034-17		Cage induction motors when fed from converters - Application guide
IEC 60034-30-1		Electrical rotating machines: efficiency classes for single-speed three-phase cage induction motors (IE code)
IEC 60038		IEC standard voltages
IEC 60072-1		Dimensions and power series for electrical rotating machines: designation of casings between 56 and 400 and flanges between 55 and 1080
IEC 60085		Evaluation and thermal classification of electrical insulation
IEC 60721-2-1		Classification of natural environment conditions. Temperature and humidity
IEC 60892		Effects of an imbalance in the voltage system on the characteristics of three-phase squirrel-cage induction motors
IEC 61000-2-10/11 and 2-2		Electromagnetic compatibility (EMC): environment
IEC guide 106		Guidelines on the specification of environmental conditions for the determination of operating characteristics of equipment
ISO 281		Bearings - Basic dynamic loadings and nominal bearing life
ISO 1680	EN 21680	Acoustics - Test code for measuring airborne noise emitted by electrical rotating machines: a method for establishing an expert opinion for free field conditions over a reflective surface
ISO 8821		Mechanical vibration - Balancing. Conventions on shaft keys and related parts
	EN 50102	Degree of protection provided by electrical housings against extreme mechanical impacts
ISO 12944-2		Corrosion protection.

MAIN PRODUCT MARKINGS WORLDWIDE

There are lots of special markings throughout the world. They mainly concern product conformance with current user safety standards in different countries. Some markings or labels only concern energy regulations. The same country can therefore have two markings: one for safety and one for energy.



This marking is mandatory throughout the European Economic Community. It means that the product conforms to all the relevant directives. If the product does not conform to a relevant directive, it cannot be CE rated and cannot therefore bear the **CE** mark.



In **Canada and the United States**: The **CSA** mark accompanied by the letters **C** and **US** means that the product is approved for the US and Canadian markets, in accordance with the relevant American and Canadian standards. If a product has characteristics applicable to more than one type of product (eg: electrical equipment incorporating fuel combustion), the mark indicates conformance with all the relevant standards.



This marking only applies to finished products such as complete machines. A motor is just a component and is not therefore affected by this marking.

Note: c CSA us and c UL us mean the same thing but one is delivered by the CSA and the other by the UL.



The **UL Recognized Component Mark**, which is optional, indicates conformance with Canadian requirements and those of the United States. UL encourages manufacturers distributing products bearing the UL Recognized Component Mark for both countries to use this combined mark.

For Canada at least c UR us or c CSA us is required. Both are also possible.

Components covered by the UL "Recognized Component Mark" programme are designed to be installed in another device, system or final product. They should be installed in the factory, not in the field and it is possible that their performance capability will be restricted and will limit their use. When a complete product or system containing UL Recognized components is assessed, the final product assessment process can be rationalised.



Canada: energy efficiency conformance logo (optional).



USA: energy efficiency conformance logo (optional).



USA and Canada: EISA conformance logo (optional).



This marking is mandatory for the Chinese market. It indicates that the product conforms to the regulations currently in force (safety of users). Concerned electric motors are rated ≤ 1.1 kW.



The EAC mark replaces the GOST mark. It is the equivalent of the CE mark for the European Union market. This new mark covers regulations for Russia, Kazakhstan and Belarus. All products marketed in these three countries must bear this marking.

Other markings concern specific applications, such as ATEX for example.

Electro_Motor.ir

APPROVALS FOR NIDEC LEROY-SOMER MOTORS (versions derived from standard construction)

Country	Initials	Certification No.	Application
CANADA	CSA	LR 57 008 166,631	Standard adapted range (see section "Supply voltage") Complete motors
USA	UL or FUL	E 68554 SA 6704 E 206450	Impregnation systems Stator/rotor assemblies for sealed units Complete motors
FRANCE	LCIE INERIS	-	Sealing, shocks, safety

For approved special products, see the relevant documents.

INDEXES OF PROTECTION OF ELECTRICAL EQUIPMENT ENCLOSURES

In accordance with IEC 60034-5 - EN 60034-5 (IP) - IEC 62262 (IK)

1 st digit: protection against solid materials			2 nd digit protection against liquids			3 rd digit mechanical protection		
IP	Tests	Definition	IP	Tests	Definition	IK	Tests	Definition
0		No protection	0		No protection	00		No protection
1	Ø 50 mm	Protected against solid objects larger than 50 mm (e.g. accidental contact with the hand)	1		Protected against water drops falling vertically (condensation)	01		Impact energy: 0.15 J
2	Ø 12 mm	Protected against solid objects larger than 12 mm (e.g. a finger)	2		Protected against water drops falling at up to 15° from the vertical	02		Impact energy: 0.20 J
3	Ø 2.5 mm	Protected against solid objects larger than 2.5 mm (e.g. tools, wires)	3		Protected against rain falling at up to 60° from the vertical	03		Impact energy: 0.37 J
4	Ø 1 mm	Protected against solid objects larger than 1 mm (e.g. thin tools, small wires)	4		Protected against projected water from all directions	04		Impact energy: 0.50 J
5		Protected against dust (no deposits of harmful material)	5		Protected against jets of water from all directions from a hose	05		Impact energy: 0.70 J
6		Protected against any dust penetration	6		Protected against projected water comparable to big waves	06		Impact energy: 1 J
			7		Protected against the effects of immersion between 0.15 and 1 m	07		Impact energy: 2 J
			8		Protected against prolonged effects of immersion under pressure	08		Impact energy: 5 J
						09		Impact energy: 10 J
						10		Impact energy: 20 J

Example:

Example of an IP 55 machine

IP : Index of Protection

5. : Machine protected against dust and accidental contact.

Test result: no dust enters in harmful quantities, no risk of direct contact with rotating parts. The test will last for 2 hours.

.5 : Machine protected against jets of water from all directions

from hoses at 3 m distance with a flow rate of 12.5 l/min at 0.3 bar.

The test will last for 3 minutes.

Test result: no damage from water projected onto the machine.

General
Environment
Environmental limitations

NORMAL OPERATING CONDITIONS

ACCORDING TO IEC 60034-1, MOTORS CAN OPERATE IN THE FOLLOWING NORMAL CONDITIONS:

- ambient temperature within the range -16°C to +40°C
- altitude less than 1000 m
- atmospheric pressure: 1050 hPa (mbar) = (750 mm Hg)

POWER CORRECTION FACTOR

For operating conditions outside these limits, apply the power correction coefficient shown in the chart on the right while maintaining the thermal reserve, as a function of the altitude and ambient temperature.

Correction coefficient table

NB: The output power can only be corrected upwards once the ability of the motor to start the load has been checked.

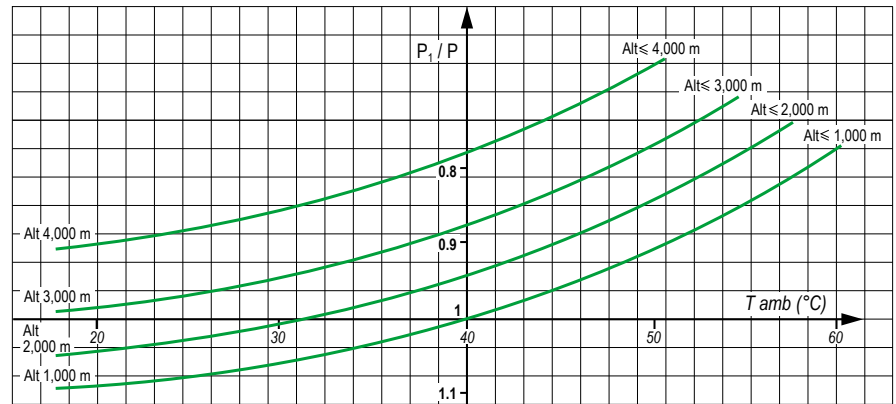

In temperate climates, relative humidity is generally between 50 and 70%. For the relationship between relative humidity and motor impregnation, especially where humidity and temperature are high, see table on next page.

NORMAL STORAGE CONDITIONS

Machines should be stored at an ambient temperature between -16°C and +80°C for aluminium motors, between -40°C and +80°C for cast iron motors, and at a relative humidity of less than 90%.

For restarting, see the commissioning manual.

RELATIVE AND ABSOLUTE HUMIDITY

MEASURING THE HUMIDITY:

Humidity is usually measured by the “wet and dry bulb thermometer” method. Absolute humidity, calculated from the readings taken on the two thermometers, can be determined using the chart on the right. The chart also provides relative humidity figures.

To determine the humidity correctly, a good air flow is required for stable readings, and accurate readings must be taken on the thermometers.

During the construction of aluminium motors, the materials of the various components which are in contact with one another are selected so as to minimise deterioration by galvanic effect. The voltages in the metal combinations used (cast iron-steel; cast iron-aluminium; steel-aluminium; steelin) are too low to cause deterioration.

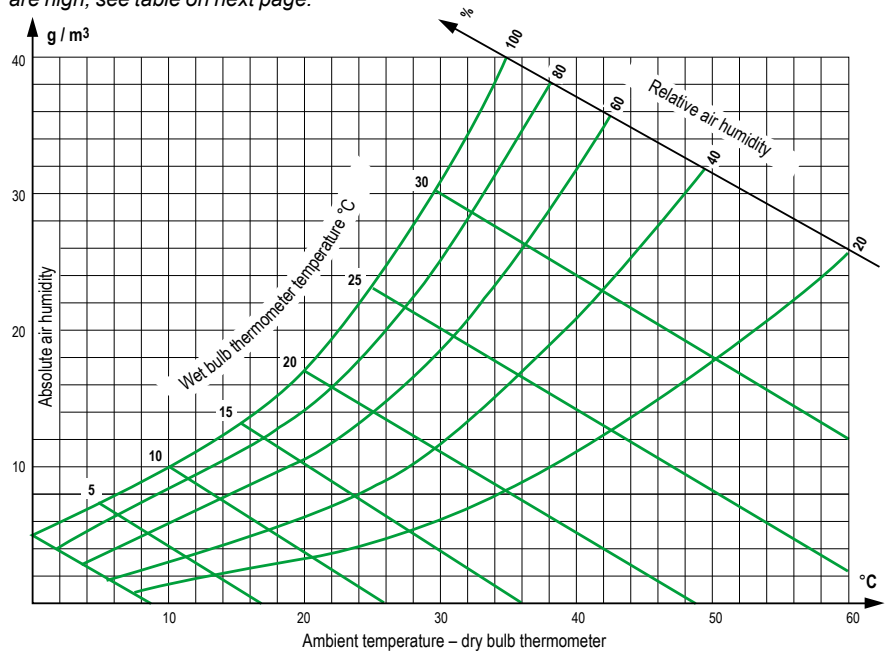

DRAIN HOLES

Holes are provided at the lowest points of the enclosure, depending on the operating position (IM, etc) to drain off any moisture that may have accumulated inside during cooling of the machine.

- The holes may be sealed in various ways:
- standard: with plastic plugs
 - on request: with screws, siphon or plastic ventilator

Under certain special conditions, it is advisable to leave the drain holes permanently open (operation in environments with high levels of condensation). Opening the holes periodically should be part of the regular maintenance procedure.

DRIP COVERS

For machines operating outdoors, with the drive shaft downwards, drip covers are recommended.

This is an option and should be specified on the order if required.

General

Environment

Impregnation and enhanced protection

NORMAL ATMOSPHERIC PRESSURE (750 MM HG)

The selection table below can be used to find the method of manufacture best suited to particular environments in which temperature and relative humidity show large degrees of variation (see relative and absolute humidity calculation method, on preceding page).

The symbols used refer to permutations of components, materials, impregnation methods and finishes (varnish or paint).

The protection of the winding is generally described by the term "tropicalization".

T: Tropicalization

TC: Complete Tropicalization

For high humidity environments, we recommend that the windings are pre-heated (see next page).

INFLUENCE OF ATMOSPHERIC PRESSURE



As atmospheric pressure decreases, air particles rarefy and the environment becomes increasingly conductive.

- P > 550 mm Hg: standard impregnation according to previous table - Possible derating or forced ventilation.

- P > 200 mm Hg : Coating of bearings - Flying leads up to a zone at P ~ 750 mm Hg - Derating to take account of insufficient ventilation - Forced ventilation.

- P < 200 mm Hg: Special manufacture based on specification.

In all cases, these problems should be resolved by a special contract worked out on the basis of a specification.

Ambient temperature	Relative humidity	RH ≤ 95%	RH > 95% ¹	Influence on construction
θ < - 40 °C		ask for estimate (quotation)	ask for estimate (quotation)	 <p>Increasing derating</p>
- 16 °C to + 50 °C		T Standard	TC Standard	
- 40 °C to + 50 °C ²		T1	TC1	
- 16 °C to + 65 °C ²		T2	TC2	
+ 65 °C to + 90 °C ²		T3	TC3	
θ > + 90 °C		ask for estimate (quotation)	ask for estimate (quotation)	
Plate mark		T	TC	
Influence on construction		 <p>Increased protection of windings</p>		

1. Atmosphere without high levels of condensation

2. For motors with a frame size ≥ 280 mm and IP23 motors with frame size ≥ 315 mm: upon offer

 Standard impregnation

General Environment Heaters

SPACE HEATERS

Severe climatic conditions, e.g. T amb < - 40°C, RH > 95% etc, may require the use of space heaters (fitted to one or two winding end coils) which serve to maintain the average temperature of the motor, provide trouble-free starting, and/or eliminate problems caused by condensation (loss of insulation).

The heater supply wires are brought out to a terminal block in the motor terminal box.

The heaters must be switched off while the motor is running.

D.C. SUPPLY INJECTION HEATING

An alternative to the use of space heaters is to inject direct current into two of the phases wired in series from a D.C. voltage source.

This is easily calculated: if R is the resistance of the windings in series, the D.C. voltage will be given by the equation (Ohm's law):

$$U_{(V)} = \sqrt{P_{(W)} \cdot R_{(\Omega)}}$$

Resistance should be measured with a micro-ohmmeter.

A.C. INJECTION HEATING

A single-phase A.C. voltage (from 10 to 15% of rated voltage), can be used between 2 phases placed in series.

This method can be used on the whole motor range.

See the mechanical and electrical options pages for each motor family to find the space heater values.



Electro_Motor.ir

General Environment External finish

Surface protection is defined in the ISO 12944 standard. This standard defines the planned lifetime of a paint system until the first major application of maintenance paint. Durability is not a guarantee.

The EN ISO 12944 standard comprises 8 sections. Part 2 covers the classification of the environments.

Nidec Leroy-Somer motors are protected with a range of surface finishes.

The surfaces receive appropriate special treatments, as shown below.

PREPARATION OF SURFACES

SURFACE	PARTS	TREATMENT
Cast iron	End shields	Shot blasting + Primer
Steel	Accessories	Phosphatization + Primer
	Terminal boxes - Fan covers	Electrostatic painting or Epoxy powder
Aluminium alloy	Housings - Terminal boxes	Shot blasting
Polymer	Fan covers- Terminal boxes Ventilation grilles	None, but must be free from grease, casting-mould coatings and dust which would affect paint adhesion

CLASSIFICATION OF THE ENVIRONMENTS

Nidec Leroy-Somer painting systems according to the categories.

ATMOSPHERIC CORROSIVE CATEGORIES	CORROSIVITY CATEGORY AS PER ISO 12944-2	Durability class	ISO 6270	ISO 9227	Nidec Leroy-Somer equivalent system	System description
			Water condensation nb hours	Salt mist nb hours		
Others	-	-	-	-	Unpainted	without any coat except cast iron parts
		-	-	-	Primer	One primer coat / Ph-Zn Pu
AVERAGE	C3	Limited	48	120	C3L	One Polyurethane coat
		Medium	120	240	-	-
		High	240	480	-	-
		Very high	480	720	-	-
HIGH	C4	Limited	120	240	-	-
		Medium	240	480	C4M	One primer coat / Ph-Zn Pu One Polyurethane coat
					C4M-P*	One Primer coat / Ph-Zn Pu One Epoxy coat
		High	480	720	-	-
		Very high	720	1440	-	-
VERY HIGH	C5	Limited	240	480	-	-
		Medium	480	720	C5M	One primer coat / Ph-Zn Epoxy One middle coat Ph-Zn Pu One Polyester / Acrylic coat
					-	-
		High	720	1440	-	-
Very high	-	-	-	-		

Standard for LSES aluminium, FLSES cast iron and PLSES steel motors

* for indoor only

Nidec Leroy-Somer standard paint colour reference:

RAL 6000

Electro_Motor.ir

Paint brightness standard: Satin

AIRBORNE INTERFERENCE EMISSION

For standard motors, the housing acts as an electromagnetic screening, reducing electromagnetic emissions measured at 0.25 metres from the motor to approximately 5 gauss (5×10^{-4} T).

However, electromagnetic emissions may be noticeably reduced by a special construction of aluminium alloy end shields and a stainless steel shaft.

IMMUNITY

The construction of motor housings (especially finned aluminium alloy frames) isolates external electromagnetic sources to the extent that any field penetrating the casing and magnetic circuit will be too weak to interfere with the operation of the motor.

POWER SUPPLY INTERFERENCE

The use of electronic systems for starting, variable speed control or power supply can create harmonics on the supply lines which may interfere with the operation of machines. These phenomena are taken into account in determining the machine dimensions, which act as quenching chokes in this respect.

The CISPR 11 standard, currently in preparation, will define permissible rejection and immunity rates.

Three-phase squirrel cage machines do not in themselves produce interference of this type. Mains connection equipment (contactors) may, however, need interference protection.

APPLICATION OF DIRECTIVE 2014/30/EC CONCERNING ELECTROMAGNETIC COMPATIBILITY (EMC)

a - for motors only

According to amendment 1 of IEC 60034-1 section 13, induction motors are not transmitters and do not produce interference (via carried or airborne signals) and therefore conform inherently to the essential requirements of the EMC directives.

b - for motors supplied by inverters (at fixed or variable frequency)

In this case, the motor is only a sub-assembly of a device which the system builder must ensure conforms to the essential requirements of the EMC directives.

APPLICATION OF LOW VOLTAGE DIRECTIVE 2014/35/EU

All motors are subject to this directive. The main requirements concern the protection of people, animals and property against risks caused by operation of the motors (see the commissioning and maintenance manual for precautions to be taken).

APPLICATION OF MACHINERY DIRECTIVE 2006/42/EC

All motors are designed to be integrated in a device subject to the machinery directive.

CE PRODUCT MARKING

The fact that motors comply with the essential requirements of the Directives is shown by the **CE** mark on their nameplates and/or packaging and documentation.

MOUNTINGS AND POSITIONS (IEC STANDARD 60034-7)

Foot mounted motors

- all frame sizes

IM 1001 (IM B3)
- Horizontal shaft
- Feet on floor

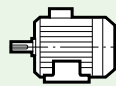

IM 1071 (IM B8)
- Horizontal shaft
- Feet on top

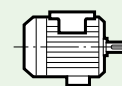

IM 1051 (IM B6)
- Horizontal shaft
- Wall mounted with feet on left when viewed from drive end

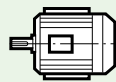

IM 1011 (IM V5)
- Vertical shaft facing down
- Feet on wall

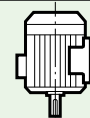

IM 1061 (IM B7)
- Horizontal shaft
- Wall mounted with feet on right when viewed from drive end

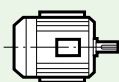

IM 1031 (IM V6)
- Vertical shaft facing up
- Feet on wall

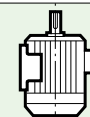

(FF) flange mounted motors

- all frame sizes (except IM 3001, which is limited to frame size 225 mm)

IM 3001 (IM B5)
- Horizontal shaft

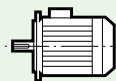

IM 2001 (IM B35)
- Horizontal shaft
- Feet on floor

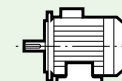

IM 3011 (IM V1)
- Vertical shaft facing down

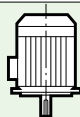

IM 2011 (IM V15)
- Vertical shaft facing down
- Feet on wall

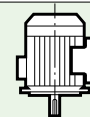

IM 3031 (IM V3)
- Vertical shaft facing up



IM 2031 (IM V36)
- Vertical shaft facing up
- Feet on wall

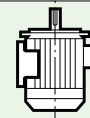

(FT) face mounted motors

- all frame sizes ≤ 160 mm

IM 3601 (IM B14)
- Horizontal shaft

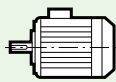

IM 2101 (IM B34)
- Horizontal shaft
- Feet on floor

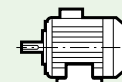

IM 3611 (IM V18)
- Vertical shaft facing down



IM 2111 (IM V58)
- Vertical shaft facing down
- Feet on wall



IM 3631 (IM V19)
- Vertical shaft facing up



IM 2131 (IM V69)
- Vertical shaft facing up
- Feet on wall

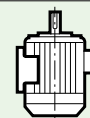

Motors without drive end shield

Warning: The protection (IP) specified on the IM B9 and IM B15 motor nameplates is provided by the customer when the motor is assembled.

IM 9101 (IM B9)
- Threaded tie rods
- Horizontal shaft

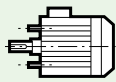

IM 1201 (IM B15)
- Foot mounted with threaded tie rods
- Horizontal shaft

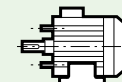

Frame size (mm)	Mounting positions											
	IM 1001	IM 1051	IM 1061	IM 1071	IM 1011	IM 1031	IM 3001	IM 3011	IM 3031	IM 2001	IM 2011	IM 2031
≤ 200	•	•	•	•	•	•	•	•	•	•	•	•
225 and 250	•	•	•	•	•	•	•	•	•	•	•	•
≥ 280	•	■	■	■	■	■	■	■	■	•	•	■

• : possible positions.

■ : please consult Nidec Leroy-Somer specifying the coupling method and the axial and radial loads if applicable

Electro_Motor.ir

General
Construction
Mains connection

TERMINAL BOX

Placed as standard on the top of the motor near the drive end, it is IP 55 protection and fitted with threaded plugs or a removable undrilled support plate.

The standard position of the plug is on the right, seen from the drive end but, owing to the symmetrical construction of the box, it can usually be placed in any of the 4 directions, as shown in the table below:

If required, the terminal box may be fitted in a different position (on the left or right as seen from the drive end, and at the DE or NDE of the motor housing).

Positions of the terminal box in relation to the drive end (motor in IM 1001 position)

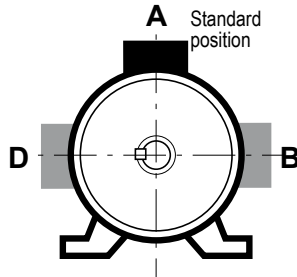

Positions of the plug in relation to the drive end

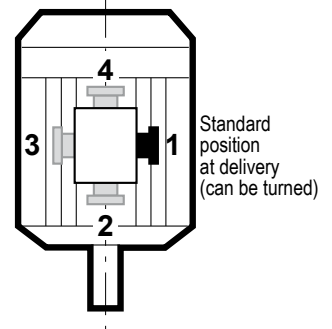

FLYING LEADS

According to specification, motors can be supplied with flying leads using single-core cables (as an option, the cables can be protected by a sheath) or multicore cables.

Please state cable characteristics (cross-section, length, number of conductors), connection method (flying leads or on a terminal block) and the drill hole position.

Terminal box position	A	B	D
LSES	●	■	■
FLSES 80 to 225 SR/MR	●	-	-
FLSES 225M to 450	●	■	■
PLSES	●	■	■

- : standard
- : please consult Nidec Leroy-Somer
- : not available

Cable gland position	1	2*	3	4
LSES - FLSES - PLSES 80 to 315	◆	★	★	★
PLSES 315 LG/MGU/VLG/VLGU PLSES 355/400	◆	-	★	-

* not recommended (impossible on (FF) flange mounted motors and on the FLSES 355LK/400/450)

- ◆ : standard
- ★ : possible by simply turning round the terminal box
- : not available

WIRING DIAGRAMS

All standard motors are supplied with a wiring diagram in the terminal box.

The diagrams normally used are shown opposite.

On the following pages are outline diagrams with internal and external connections.

EARTH TERMINAL

This is situated inside the terminal box. Consisting of a threaded stud with a hexagonal nut, it is used to connect cables with cross-sections at least as large as the cross-section of the phase conductors.

It is indicated by the sign: ⏏ in the terminal box moulding.

On request, a second earth terminal can be fitted on one of the feet or on one of the cooling fins.

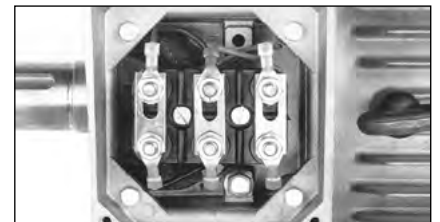
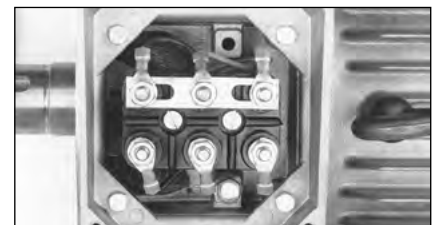
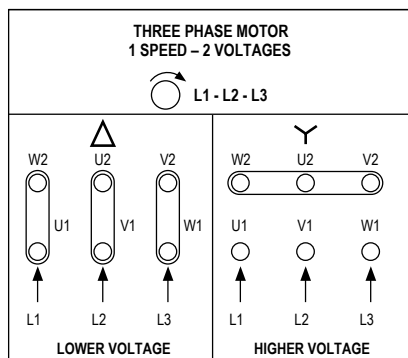

General
Construction
Radial loads

PERMISSIBLE RADIAL LOAD ON THE MAIN SHAFT EXTENSION

In pulley and belt couplings, the drive shaft carrying the pulley is subjected to a radial force F_{pr} applied at a distance X (mm) from the shoulder of the shaft extension (length E).

Radial force acting on the drive shaft: F_{pr}

The radial force F_{pr} expressed in daN applied to the drive shaft is found by the formula.

$$F_{pr} = 1.91 \cdot 10^6 \frac{P_N \cdot k}{D \cdot N_N} \pm P_P$$

where:

P_N = rated motor power (kW)

D = external diameter of the drive pulley (mm)

N_N = rated motor speed (min^{-1})

k = factor depending on the type of transmission

P_P = weight of the pulley (daN)

The weight of the pulley is positive when it acts in the same direction as the tension force in the belt (and negative when it acts in the opposite direction).

Range of values for factor k (*)

- toothed belts: $k = 1$ to 1.5

- V-belts: $k = 2$ to 2.5

- flat belts

• with tensioner: $k = 2.5$ to 3

• without tensioner: $k = 3$ to 4

(*) A more accurate figure for factor k can be obtained from the transmission suppliers.

Permissible radial force on the drive shaft:

The charts on the following pages indicate, for each type of motor, the radial force FR at a distance X permissible on the drive end shaft extension, for a bearing life L_{10h} of 25,000 hours.

Note: For frame sizes ≥ 315 M, the selection charts are applicable for a motor installed with the shaft horizontal.

Change in bearing life depending on the radial load factor.

For a radial load F_{pr} ($F_{pr} \neq FR$), applied at distance X , the bearing life L_{10h} changes, as a rough estimate, in the ratio k_R ($k_R = F_{pr}/FR$) as shown in the chart below, for standard fitting arrangements.

If the load factor k_R is greater than 1.05,

you should consult our technical department, stating mounting position and direction of force before opting for a special fitting arrangement.

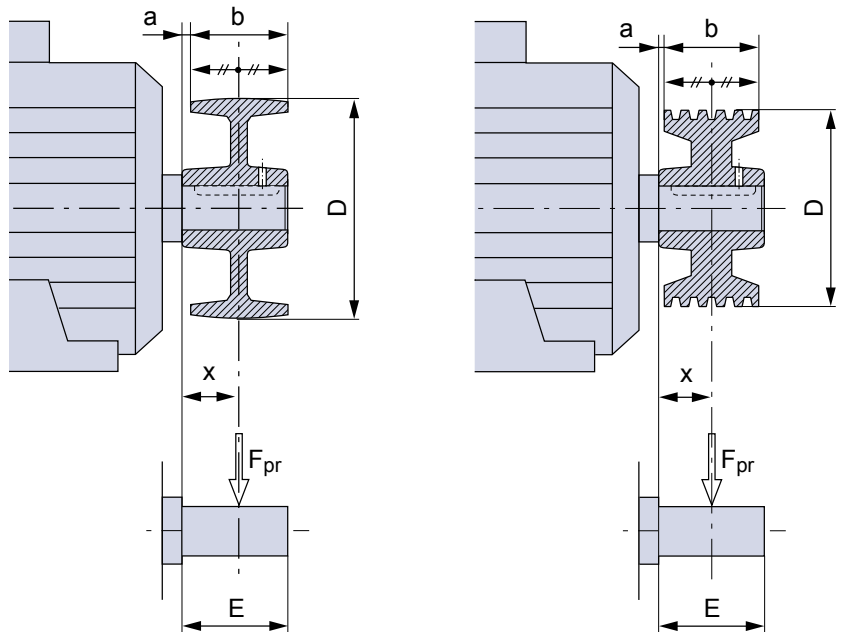

$$\left\{ \begin{array}{l} x = a + \frac{b}{2} \\ \text{where} \\ x \leq E \end{array} \right.$$

$$\left\{ \begin{array}{l} x = a + \frac{b}{2} \\ \text{where} \\ x \leq E \end{array} \right.$$

Change in bearing life L_{10h} depending on the radial load factor k_R for standard fitting arrangements.

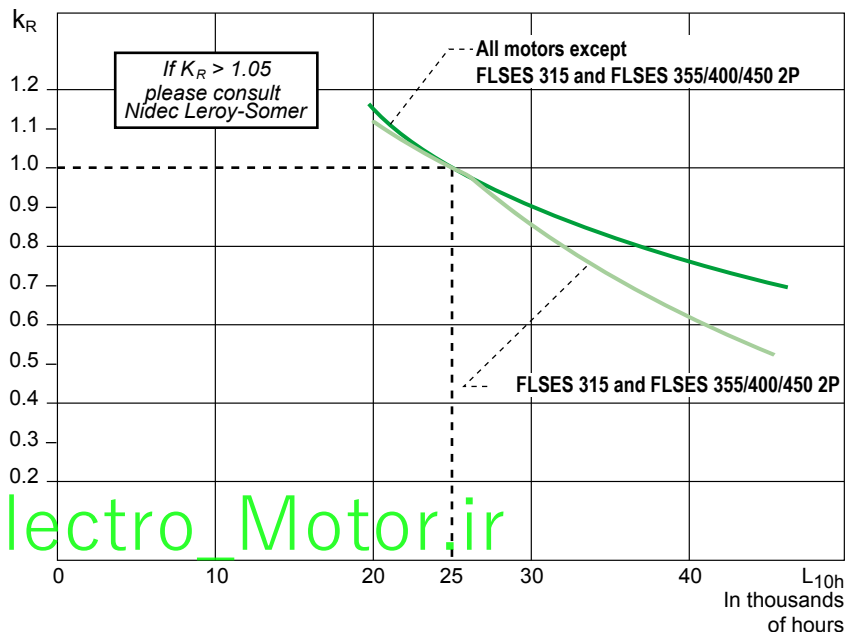

Electro_Motor.ir

General Construction Cooling

Designation for the IC (International Cooling) coded cooling method in the IEC 60034-6 standard.

The standard allows for two designations (general formula and simplified formula) as shown in the example opposite.

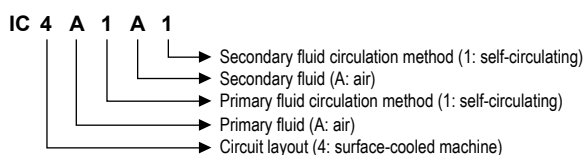

NB: The letter A may be omitted if this will not lead to confusion. This contracted formula becomes the simplified formula.
Simplified form: **IC 411**.

Circuit layout

Characteristic number	Abbreviated designation	Description
0(1)	Free circulation	The coolant enters and leaves the machine freely. It is taken from and returned to the fluid round the machine.
1(1)	Machine with one intake pipe	The coolant is taken up elsewhere than from the fluid round the machine, brought into the machine through an intake pipe and emptied into the fluid round the machine.
2(1)	Machine with one outlet pipe	The coolant is taken up from the fluid round the machine, brought away from the machine by an outlet pipe and does not go back into the fluid round the machine.
3(1)	Machine with two pipes (intake and outlet)	The coolant is taken up elsewhere than from the fluid round the machine, brought to the machine through an intake pipe, then taken away from the machine through an outlet pipe and does not go back into the fluid round the machine.
4	Surface cooled machine using the fluid round the machine	The primary coolant circulates in a closed circuit, transferring its heat to a secondary coolant (the one surrounding the machine) through the machine casing. The casing surface is either smooth or finned to improve heat transmission.
5(2)	Built-in heat exchanger (using the surrounding environment)	The primary coolant circulates in a closed circuit, transferring its heat to a secondary coolant (the one surrounding the machine) in an integral heat exchanger inside the machine.
6(2)	Machine-mounted heat exchanger (using the surrounding environment)	The primary coolant circulates in a closed circuit, transferring its heat to a secondary coolant (the one surrounding the machine) in a heat exchanger that forms an independent unit, mounted on the machine.
7(2)	Built-in heat exchanger (not using the surrounding environment)	The primary coolant circulates in a closed circuit, transferring its heat to a secondary coolant (which is not the one round the machine) in an integral heat exchanger inside the machine.
8(2)	Machine-mounted heat exchanger (not using the surrounding environment)	The primary coolant circulates in a closed circuit, transferring its heat to a secondary coolant (which is not the one round the machine) in a heat exchanger that forms an independent unit, mounted on the machine.
9(2)(3)	Separate heat exchanger (using the surrounding environment or not)	The primary coolant circulates in a closed circuit, transferring its heat to the secondary fluid in a heat exchanger that forms an independent unit, away from the machine.

Coolant

Characteristic letter	Type of fluid
A	Air
F	Freon
H	Hydrogen
N	Nitrogen
C	Carbon dioxide
W	Water
U	Oil
S	Any other fluid (must be identified separately)
Y	The fluid has not yet been selected (used temporarily)

Method of circulation

Characteristic number	Designation abbreviated	Description
0	Free circulation	The circulation of the coolant is due only to differences in temperature. Ventilation caused by the rotor is negligible.
1	Self-circulating	The circulation of the coolant depends on the rotational speed of the main machine, and is caused by the action of the rotor alone, or a device mounted directly on it.
2, 3, 4		Not yet defined.
5(4)	Built-in and independent device	The coolant is circulated by a built-in device which is powered independently of the rotational speed of the main machine.
6(4)	Independent device mounted on the machine	The coolant is circulated by a device mounted on the machine which is powered independently of the rotational speed of the main machine.
7(4)	Entirely separate independent device or using the pressure of the coolant circulation system	The coolant is circulated by a separate electrical or mechanical device, independent and not mounted on the machine, or by the pressure in the coolant circulation system.
8(4)	Relative displacement	The circulation of the coolant is produced by the relative movement between the machine and the coolant, either by displacement of the machine in relation to the coolant, or by the flow of the surrounding coolant.
9	All other devices	The coolant is circulated using a method other than those defined above: it must be described in full.

(1) Filters or labyrinth seals for dust removal or noise protection can be fitted inside the casing or in the ducting. The first characteristic numbers 0 to 3 also apply to machines in which the coolant is taken up at the outlet of a water-cooler designed to lower the temperature of the ambient air or recirculated through a water-cooler so as not to increase the ambient temperature.

(2) The nature of the heat exchanger elements is not specified (smooth or finned tubes, corrugated surfaces, etc.).

(3) A separate heat exchanger can be installed near to or at a distance from the machine. A secondary gas coolant may be the surrounding environment or not.

(4) Use of such a device does not exclude the ventilating action of the rotor or the existence of an additional fan mounted directly on the rotor.

General Construction Cooling

MOTOR VENTILATION

In compliance with IEC 60034-6, the motors in this catalogue are cooled using method IC 411, ie. “surface-cooled machine using the ambient air circulating round the machine”.

Cooling is achieved by a fan mounted at the non-drive end of the motor, inside a fan cover which acts as a safety guard (check according to IEC 600 34-5). The fan draws the air through the grille in the cover and blows it along the housing fins, giving an identical heat balance in either direction of rotation.

NB: Obstruction, even accidental, of the fan cover grille (grille clogged or placed against a wall) seriously impairs motor cooling.

We recommend a minimum distance of 1/3 of the frame size between the end of the cover and any possible obstacle (wall, machine, etc).

NON-VENTILATED APPLICATIONS IN CONTINUOUS OPERATION

Motors can be supplied without fans. Dimensions will depend on the application.

IC 418 COOLING SYSTEM

If they are placed in the air flow from a fan, these motors are capable of supplying their rated power if the speed of the air between the housing fins and the overall flow rate of the air between the fins comply with the data in the table below.

Type LSES/FLSES	2 poles		4 poles		6 poles	
	flow rate m ³ /h	speed m/s	flow rate m ³ /h	speed m/s	flow rate m ³ /h	speed m/s
80	120	7.5	60	4	40	2.5
90	200	11.5	75	5.5	60	3.5
100	300	15	130	7.5	95	5
112	460	18	200	9	140	6
132	570	21	300	10.5	220	7
160	1000	21	600	12.5	420	9
180	1200	21	900	16	600	10
200	1800	23	1200	16	750	10
225	2000	24	1500	18	1700	13
250	3000	25	2600	20	1700	13
280	3000	25	2600	20	2000	15
315	5000	25	2600	20	2000	15
355	5200	25	2800	20	2200	15
400	5500	25	3000	20	2600	15
450	6000	25	3200	20	2600	15

These air flows are valid for normal operating conditions as described in the “Environmental limitations” section.

STANDARD CODES

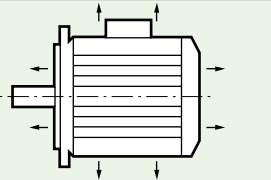
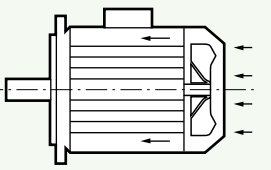
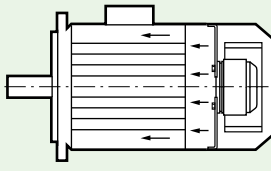
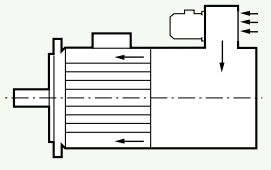
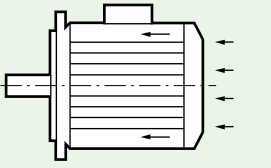
<p>IC 410</p>	<p>Enclosed machine ,surface-cooled by natural convection and radiation. No external fan.</p>	
<p>IC 411</p>	<p>Enclosed machine. Smooth or finned ventilated casing. External shaft-mounted fan.</p>	
<p>IC 416 A*</p>	<p>Enclosed machine. Smooth or finned enclosed casing. External motorized axial (A) fan supplied with the machine.</p>	
<p>IC 416 R*</p>	<p>Enclosed machine. Smooth or finned enclosed casing. External motorized radial (R) fan supplied with the machine.</p>	
<p>IC 418</p>	<p>Enclosed machine. Smooth or finned casing. No external fan. Ventilation provided by air flow coming from the driven system.</p>	

* Features not within manufacturer's standard range.

General
Construction
Motor connections

SINGLE SPEED MOTORS

Voltages and connections	Internal wiring diagrams	Winding outline diagrams	External connection diagrams	
			D.O.L. starting	Y / Δ starting
Single voltage type motors (3 TERMINALS)				
- Voltage: U - Connection: Y internal Eg: 400 V/Y				
- Voltage: U - Connection: internal Δ e.g. 400 V / Δ				
Dual-voltage motors with Y, Δ connections (6 TERMINALS)				
- Voltage: U - Connection: Δ (at lower voltage) e.g. 230 V / Δ				
- Voltage: U√3 - Connection: Y (at higher voltage) Eg: 400 V/Y				
Dual-voltage motors with series-parallel connections (9 TERMINALS)				
- Voltage: U - Connection: Y Y (at lower voltage) Eg: 230 V / Y Y				
- Voltage: 2 U - Connection: Y (series-star at higher voltage) Eg: 460 V/Y				

General
Construction
Bearings and bearing life

DEFINITIONS

LOAD RATINGS

Static load rating Co:

This is the load for which permanent deformation at point of contact between a bearing race and the ball (or roller) with the heaviest load reaches 0.01% of the diameter of the ball (or roller).

Dynamic load rating C:

This is the load (constant in intensity and direction) for which the nominal lifetime of the bearing will reach 1 million revolutions.

The static load rating Co and dynamic load rating C are obtained for each bearing by following the method in ISO 281.

LIFETIME

The lifetime of a bearing is the number of revolutions (or number of operating hours at a constant speed) that the bearing can accomplish before the first signs of fatigue (spalling) begin to appear on a ring, ball or roller.

Nominal lifetime L10h

According to the ISO recommendations, the nominal lifetime is the length of time achieved or exceeded by 90% of apparently identical bearings operating under the conditions specified by the manufacturer.

Note: The majority of bearings last much longer than the nominal lifetime; the average lifetime achieved or exceeded by 50% of bearings is around 5 times longer than the nominal lifetime.

DETERMINATION OF NOMINAL LIFETIME

Constant load and speed of rotation

The nominal lifetime of a bearing expressed in operating hours L10h, the dynamic load rating C expressed in daN and the applied loads (radial load Fr and axial load Fa) are related by the following equation:

$$L_{10h} = \frac{1000000}{60 \cdot N} \cdot \left(\frac{C}{P}\right)^p$$

where N = speed of rotation (rpm)

P (P = X Fr + Y Fa): equivalent dynamic load (Fr, Fa, P in daN)

p: exponent which is a function of the contact between the races and balls (or rollers)

p = 3 for ball bearings

p = 10/3 for roller bearings

The formulae that give Equivalent Dynamic Load (values of factors X and Y) for different types of bearing may be obtained from the various manufacturers.

Variable load and speed of rotation

For bearings with periodically variable load and speed, the nominal lifetime is established using the equation:

$$L_{10h} = \frac{1000000}{60 \cdot N_m} \cdot \left(\frac{C}{P_m}\right)^p$$

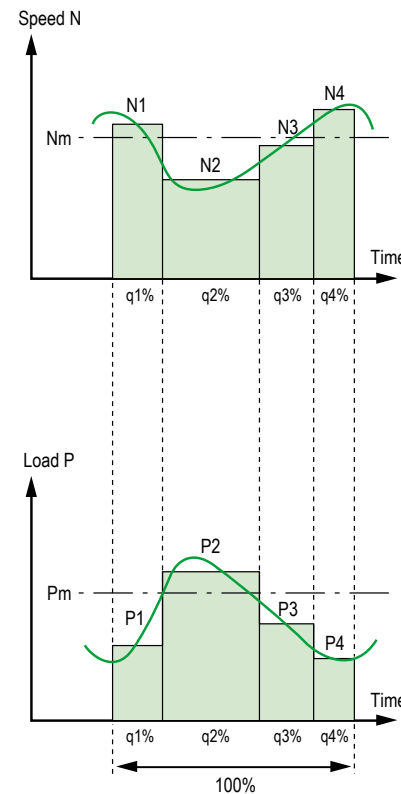

N_m: average speed of rotation

$$N_m = N_1 \cdot \frac{q_1}{100} + N_2 \cdot \frac{q_2}{100} + \dots (\text{min}^{-1})$$

P_m: average equivalent dynamic load

$$P_m = P \sqrt[10]{P_1^p \cdot \left(\frac{N_1}{N_m}\right) \cdot \frac{q_1}{100} + P_2^p \cdot \left(\frac{N_2}{N_m}\right) \cdot \frac{q_2}{100} + \dots (\text{daN})}$$

with q1, q2, etc as a %

Nominal lifetime L10h is applicable to bearings made of bearing steel and normal operating conditions (lubricating film present, no contamination, correctly fitted, etc).

Situations and data differing from these conditions will lead to either a reduction or an increase in lifetime compared to the nominal lifetime.

Corrected nominal lifetime

If the ISO recommendations (DIN ISO 281) are used, improvements to bearing steel, manufacturing processes and the effects of operating conditions may be integrated in the nominal lifetime calculation.

The theoretical pre-fatigue lifetime L_{nah} is thus calculated using the formula:

$$L_{nah} = a_1 a_2 a_3 L_{10h}$$

where:

a₁: failure probability factor.

a₂: factor for the characteristics and tempering of the steel.

a₃: factor for the operating conditions (lubricant quality, temperature, speed of rotation, etc).

General

Construction

Lubrication and maintenance of bearings

ROLE OF THE LUBRICANT

The principal role of the lubricant is to avoid direct contact between the metal parts in motion: balls or rollers, slip-rings, cages, etc. It also protects the bearing against wear and corrosion.

The quantity of lubricant needed by a bearing is normally quite small. There should be enough to provide good lubrication without undesirable overheating. As well as lubrication itself and the operating temperature, the amount of lubricant should be judged by considerations such as sealing and heat dissipation.

The lubricating power of a grease or an oil lessens with time owing to mechanical constraints and straight forward ageing. Used or contaminated lubricants should therefore be replaced or topped up with new lubricant at regular intervals.

Bearings can be lubricated with grease, oil or, in certain cases, with a solid lubricant.

GREASING

A lubricating grease can be defined as a product of semi-fluid consistency obtained by the dispersion of a thickening agent in a lubricating fluid and which may contain several additives to give it particular properties.

Composition of a grease
Base oil: 85 to 97%
Thickener: 3 to 15 %
Additives: 0 to 12 %

THE BASE OIL LUBRICATES

The oil making up the grease **is of prime importance**. It is the oil that lubricates the moving parts by coating them with a protective film which prevents direct contact. The thickness of the lubricating film is directly linked to the viscosity of the oil, and the viscosity itself depends on temperature. The two main types used to make grease are mineral oils and synthetic oils. Mineral oils are suitable for normal applications in a range of temperatures from -30°C to +150°C.

Synthetic oils have the advantage of being effective in severe conditions (extreme variations of temperature, harsh chemical environments, etc).

THE THICKENER GIVES THE GREASE CONSISTENCY

The more thickener a grease contains, the "harder" it will be. Grease consistency varies with the temperature. In falling temperatures, the grease hardens progressively, and the opposite happens when temperatures rise.

The consistency of a grease can be quantified using the NLGI (National Lubricating Grease Institute) classification. There are 9 NLGI grades, from 000 for the softest greases up to 6 for the hardest. Consistency is expressed by the depth to which a cone may be driven into a grease maintained at 25°C.

If we only consider the chemical nature of the thickener, lubricating greases fall into three major categories:

- **Conventional greases with a metallic soap base** (calcium, sodium, aluminium, lithium). Lithium soaps have several advantages over other metallic soaps: a high melting point (180° to 200°), good mechanical stability and good water resistant properties.

- **Greases with a complex soap base.** The main advantage of this type of soap is a very high melting point (over 250°C).

- **Soapless greases.** The thickener is an inorganic compound, such as clay. Their main property is the absence of a melting point, which makes them practically non-liquefying.

ADDITIVES IMPROVE SOME GREASE PROPERTIES

Additives fall into two types, depending on whether or not they are soluble in the base oil.

The most common insoluble additives - graphite, molybdenum disulphide, talc, mica, etc, improve the friction characteristics between metal surfaces. They are therefore used in applications where heavy pressure occurs.

The soluble additives are the same as those used in lubricating oils: antioxidants, anti-rust agents, etc.

LUBRICATION TYPE

The bearings are lubricated with a polyurea soap-based grease.

DUTY CYCLES

(IEC 60034-1)

The typical duty cycles are described below:

1 - Continuous duty - Type S1

Operation at constant load of sufficient duration for thermal equilibrium to be reached (see figure 1).

Note: 6 successive starts from the cold stage of the motor, and 2 from hot state with return to stop stage between each start.

2 - Short-time duty - Type S2

Operation at constant load during a given time, less than that required for thermal equilibrium to be reached, followed by a rest and de-energized period of sufficient duration to re-establish machine temperatures within 2 K of the coolant (see figure 2).

3 - Intermittent periodic duty - Type S3

A sequence of identical duty cycles, each consisting of a period of operation at constant load and a rest and deenergized period (see figure 3). Here, the cycle is such that the starting current does not significantly affect the temperature rise.

4 - Intermittent periodic duty with starting - Type S4

A sequence of identical duty cycles, each consisting of a significant starting period, a period of operation at constant load and a rest and de-energized period (see figure 4).

5 - Intermittent periodic duty with electrical braking, Type S5.

A sequence of periodic duty cycles, each consisting of a starting period, a period of operation at constant load, a period of rapid electrical braking and a rest and de-energized period (see figure 5).

6 - Periodic continuous duty with intermittent load, Type S6.

A sequence of identical duty cycles, each consisting of a period of operation at constant load and a period of operation at no load. There is no rest and deenergized period (see figure 6).

7 - Periodic continuous duty with electrical braking, Type S7.

A sequence of identical duty cycles, each consisting of a starting period, a period of operation at constant load and a period of electrical braking. There is no rest and de-energized period (see figure 7).

8 - Periodic continuous duty with related changes of load and speed - Type S8

A sequence of identical duty cycles, each consisting of a period of operation at constant load corresponding to a predetermined rotation speed, followed by one or more periods of operation at other constant loads corresponding to different rotation speeds (in induction motors, this can be done by changing the number of poles). There is no rest and de-energized period (see figure 8).

9 - Duty with non-periodic variations in load and speed - Type S9

This is a duty in which the load and speed generally vary non-periodically within the permissible operating range. This duty frequently includes applied overloads which may be much higher than the full load or loads (see figure 9).

Note: for this type of duty, the appropriate full load values must be used as the basis for calculating overload.

10 - Operation at discrete constant loads - Type S10

This duty consists of a maximum of 4 discrete load values (or equivalent loads), each value being applied for sufficient time for the machine to reach thermal equilibrium. The minimum load during a load cycle may be zero (no-load operation or rest and de-energized period) (see figure 10).

NB: only S1 duty type is affected by IEC 60034-30-1

Fig. 1. - Continuous duty, Type S1.

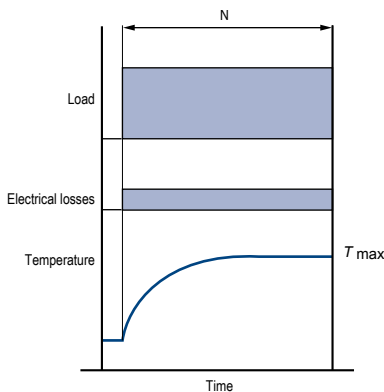

N = operation at constant load
T_{max} = maximum temperature attained

Fig. 2. - Short-time duty, Type S2.

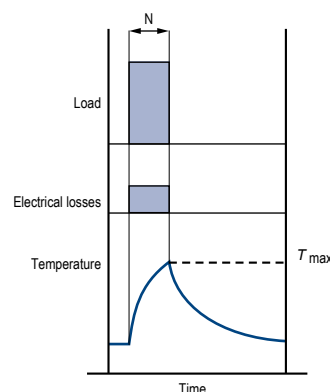

N = operation at constant load
T_{max} = maximum temperature attained

Fig. 3. - Intermittent periodic duty, Type S3.

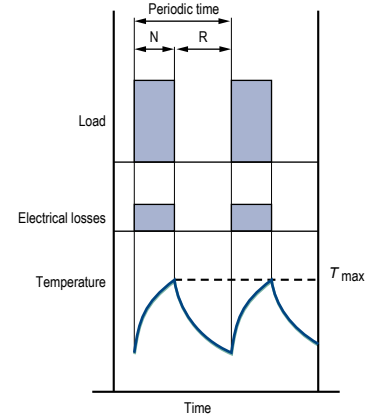

N = operation at constant load
R = rest
T_{max} = maximum temperature attained
Running factor (%) = $\frac{N}{N + R} \cdot 100$

General
Operation
Duty cycle - Definitions

Fig. 4. - Intermittent periodic duty with starting, Type S4.

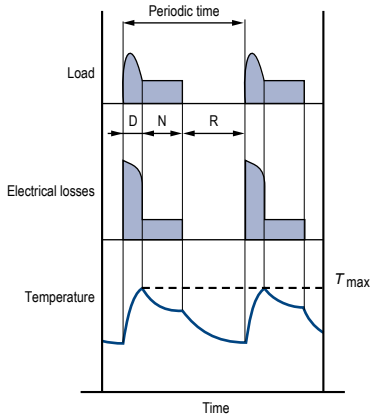

D = starting
 N = operation at constant load
 R = rest
 T_{max} = maximum temperature attained during cycle
 Operating factor (%) = $\frac{D + N}{N + R + D} \cdot 100$

Fig. 5. - Intermittent periodic duty with electrical braking, Type S5.

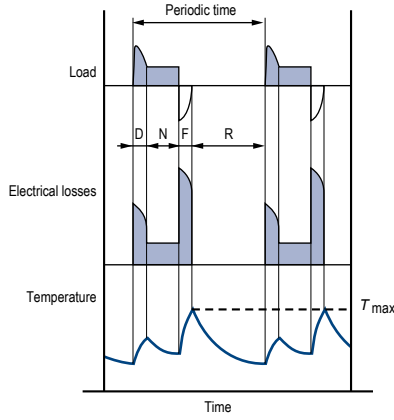

D = starting
 N = operation at constant load
 F = electrical braking
 R = rest
 T_{max} = maximum temperature attained during cycle
 Operating factor (%) = $\frac{D + N + F}{D + N + F + R} \cdot 100$

Fig. 6. - Periodic continuous duty with intermittent load, Type S6.

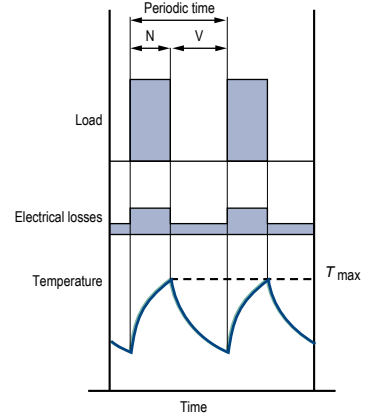

N = operation at constant load
 V = no-load operation
 T_{max} = maximum temperature attained during cycle
 Operating factor (%) = $\frac{N}{N + V} \cdot 100$

Fig. 7. - Periodic continuous duty with electrical braking, Type S7.

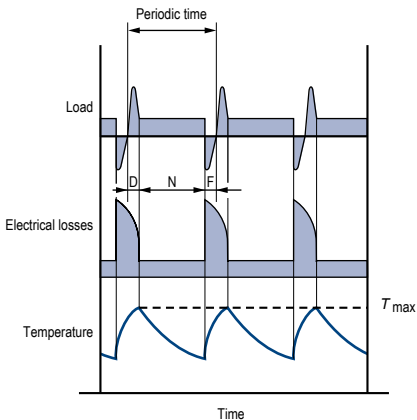

D = starting
 N = operation at constant load
 F = electrical braking
 T_{max} = maximum temperature attained during cycle
 Operating factor = 1

Fig. 8. - Periodic continuous duty with related changes of load and speed, Type S8.

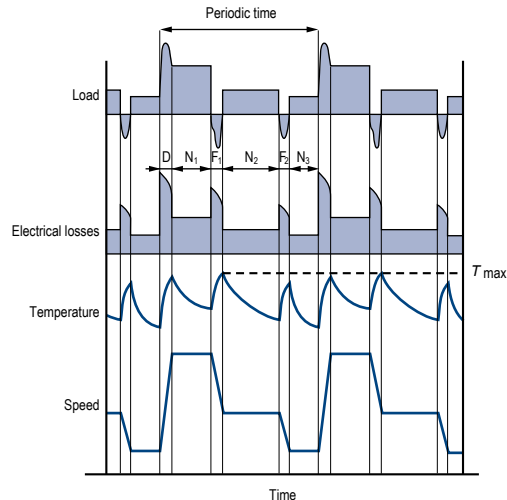

F₁F₂ = electric braking
 D = starting
 N₁N₂N₃ = operation at constant loads
 T_{max} = maximum temperature attained during cycle

Operating factor = $\frac{D + N_1}{D + N_1 + F_1 + N_2 + F_2 + N_3} \cdot 100\%$
 $\frac{F_1 + N_2}{D + N_1 + F_1 + N_2 + F_2 + N_3} \cdot 100\%$
 $\frac{F_2 + N_3}{D + N_1 + F_1 + N_2 + F_2 + N_3} \cdot 100\%$

Fig. 9. - Duty with non-periodic variations in load and speed, Type S9.

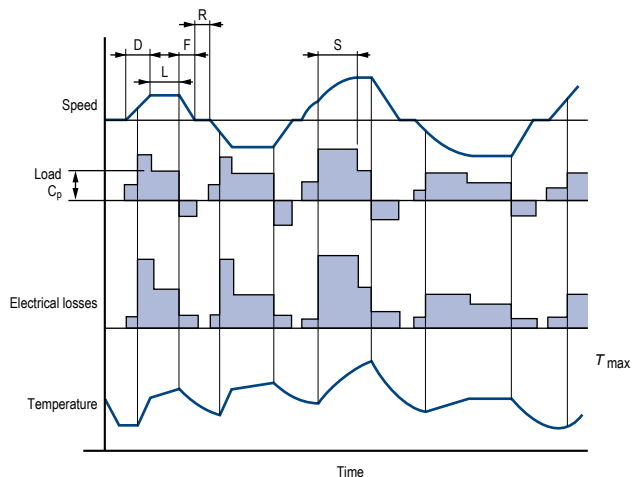

- D = starting
- L = operation at variable loads
- F = electrical braking
- R = rest
- S = operation at overload
- C_p = full load
- T_{max} = maximum temperature attained

Fig. 10 - Duty at discrete constant loads, Type S10.

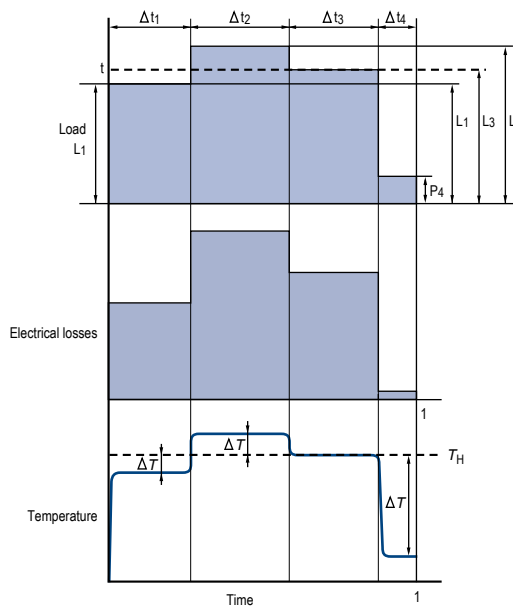

- L = load
- N = rated power for type S1 duty
- $p = p / \frac{L}{N}$ = reduced load
- t = time
- T_p = total cycle time
- t_i = discrete period within a cycle
- $\Delta t_i = t_i / T_p$ = relative duration of period within a cycle
- P_u = electrical losses
- H_N = temperature at rated power for type S1 duty
- ΔH_i = increase or decrease in temperature rise during the ith period of the cycle

Power is determined according to duty cycle. See "Operation" section, § "Power - Torque - Efficiency - Power Factor (Cos φ)".

For duty ratings between S3 and S8 inclusive, the default cycle is 10 minutes unless otherwise indicated.

Electro_Motor.ir

REGULATIONS AND STANDARDS

The IEC 60038 standard gives the European reference voltage as 230/400 V three-phase and 230 V single-phase, with a tolerance of $\pm 10\%$.

The IEC 60034-1 standard give $\pm 2\%$ on the frequency.

EFFECTS ON MOTOR PERFORMANCE

VOLTAGE RANGE

The characteristics of motors will of course vary with a corresponding variation in voltage of $\pm 10\%$ around the rated value.

An approximation of these variations is given in the table opposite.

	Voltage variation as a %				
	UN-10%	UN-5%	UN	UN+5%	UN+10%
Torque curve	0.81	0.90	1	1.10	1.21
Slip	1.23	1.11	1	0.91	0.83
Rated current	1.10	1.05	1	0.98	0.98
Rated efficiency	0.97	0.98	1	1.00	0.98
Rated power factor (cos φ)	1.03	1.02	1	0.97	0.94
Starting current	0.90	0.95	1	1.05	1.10
Nominal temperature rise	1.18	1.05*	1	1*	1.10
P (Watt) no-load	0.85	0.92	1	1.12	1.25
Q (reactive VA) no-load	0.81	0.9	1	1.1	1.21

* According to standard IEC 60034-1, the additional temperature rise must not exceed 10 K within $\pm 5\%$ of U_N .

General
Operation
Supply voltage

SIMULTANEOUS VARIATION OF VOLTAGE AND FREQUENCY

Within the tolerances defined in guide 106 of the IEC (see § D2.1), machine input and performance are unaffected if the variations are of the same polarity and the voltage/frequency ratio U/f remains constant.

If this is not the case, variations in performance are significant and require the machine specification to be changed.

Variation in main motor parameters (approx.) within the limits defined in IEC Guide 106.

U/f	Pu	M	N	Cos φ	Efficiency
Constant	$P_u \frac{f'}{f}$	M	$N \frac{f'}{f}$	cos φ unchanged	Efficiency unchanged
Variable	$P_u \left(\frac{U'}{U}\right)^2$	$M \left(\frac{U'}{U}\right)^2$	$N \frac{f'}{f}$	Dependent on the machine saturation state	

M = minimum and maximum values of starting torque.

USE OF 400 V - 50 HZ MOTORS ON 460 V - 60 HZ SUPPLIES

For a rated power at 60 Hz equal to the rated power at 50 Hz, the main characteristics are modified according to the following variations:

- Efficiency increases by 0.5 - 1.5%
- Power factor decreases by 0.5 to 1.5%
- Rated current decreases by 0 to 5%
- IS/IN increases by around 10%
- Slip and rated torque MN, MD/MN, MM/MN remain more or less constant.

USE ON SUPPLIES WITH U' VOLTAGES different from the voltages in the characteristics tables

In this case, the machine windings should be adjusted.

As a result, only the current values will be changed and become:

$$I' = I_{400V} \times \frac{400}{U'}$$

PHASE VOLTAGE IMBALANCE

The phase imbalance for voltage is calculated as follows:

$$\text{Phase voltage imbalance as a \%} = 100 \times \frac{\text{maximum difference in voltage compared to the average voltage value}}{\text{average voltage value}}$$

to establish the type of motor required, to apply the derating specified in standard IEC 60892, illustrated on the graph opposite.

Percentage imbalance	0	2	3.5	5
Stator current	100	101	104	107.5
Increase in losses as a %	0	4	12.5	25
Temperature rise	1	1.05	1.14	1.28

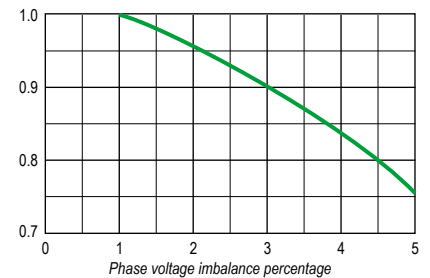

The effect on motor performance is summarized in the table opposite.

When this imbalance is known before the motor is purchased, it is advisable, in order

PHRASE CURRENT IMBALANCE

Voltage imbalances induce current imbalances. Natural lack of symmetry due to manufacture also induces current imbalances.

The chart opposite shows the ratios in which the negative phase component is equal to 5% (and 3%) of the positive phase components in three-phase current supplies without zero components (neutral absent or not connected).

Inside the curve, the negative phase component is lower than 5% (and 3%).

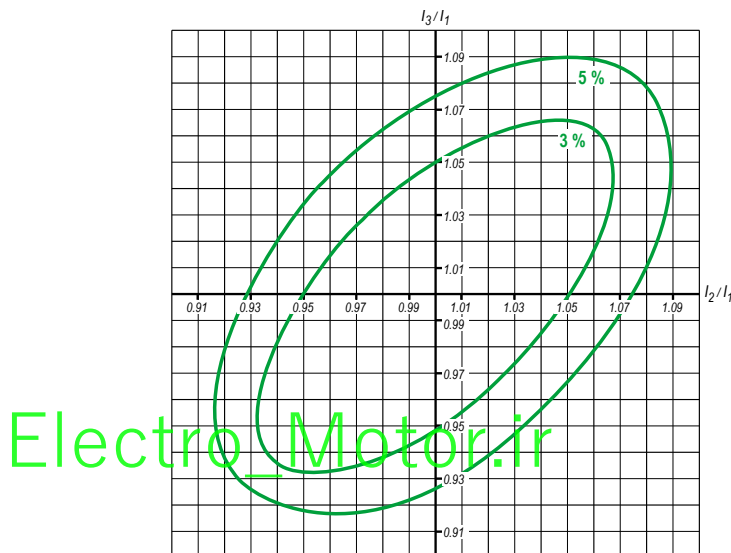

INSULATION CLASS

The machines in this catalogue have been designed with a class F insulation system for the windings.

Class F allows for temperature rises of 105 K (measured by the resistance variation method) and maximum temperatures at the hot spots in the machine of 155°C (Ref. IEC 60085 and IEC 60034-1).

Complete impregnation with tropicalized varnish of thermal class 180°C gives protection against attacks from the environment, such as: 90% relative humidity, interference, etc.

For special constructions, the winding is class H and impregnated with special varnishes which enable it to operate in conditions of high temperatures with relative air humidity of up to 100%.

The insulation of the windings is monitored in two ways:

a - Dielectric inspection which involves checking the leakage current, at an applied voltage of (2U + 1000 V), in conditions complying with standard IEC 60034-1 (systematic test).

b - Monitoring the insulation resistance between the windings and between the windings and the earth (sampling test) at a D.C. voltage of 500 V or 1000 V.

TEMPERATURE RISE AND THERMAL RESERVE

Nidec Leroy-Somer motors are built to have a maximum winding temperature rise of 80 K under normal operating conditions (ambient temperature 40°C, altitude below 1000 m, rated voltage and frequency, rated load).

The result is a thermal reserve linked to the following factors:

- A difference of 25 K between the nominal temperature rise (Un, Fn, Pn) and the permissible temperature rise (105 K) for class F insulation.
- A difference of 10°C minimum at the voltage limits.

In IEC60034-1 and 60034-2, temperature rise ($\Delta\theta$), is calculated using the winding resistance variation method, with the formula:

$$\Delta T = \frac{R_2 - R_1}{R_1} (235 + T_1) + (T_1 - T_2)$$

R_1 : cold resistance measured at ambient temperature T_1

R_2 : stabilized hot resistance measured at ambient temperature T_2

235: coefficient for a copper winding (for an aluminium winding, the coefficient is 225)

Temperature rise (ΔT^*) and maximum temperatures at hot spots (T_{max}) for insulation classes (IEC 60034-1).

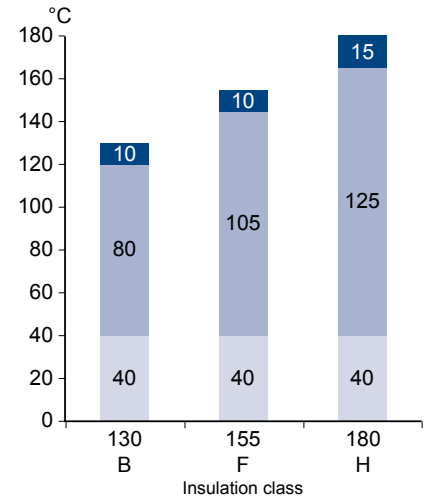

■ Temperature rise at hot spots Tmax
 ■ Temperature rise
 ■ Ambient temperature

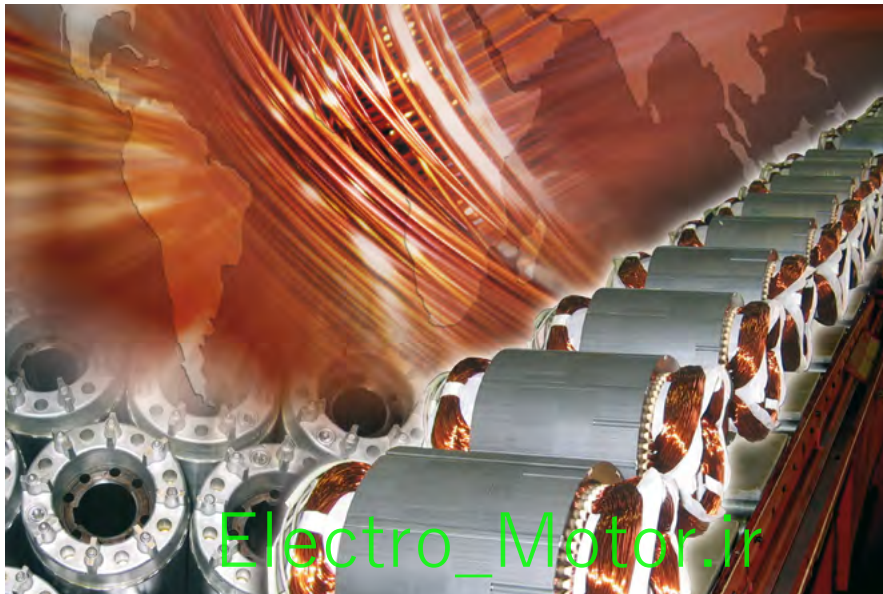

Electro_Motor.ir

PERMISSIBLE STARTING TIMES AND LOCKED ROTOR TIMES

The calculated starting times must remain within the limits of the graph opposite which defines maximum starting times in relation to the current surge.

6 successive cold starts and two consecutive hot starts are allowed with return to stop between each start.

Permissible motor starting time as a function of the ratio I_d/I_n .

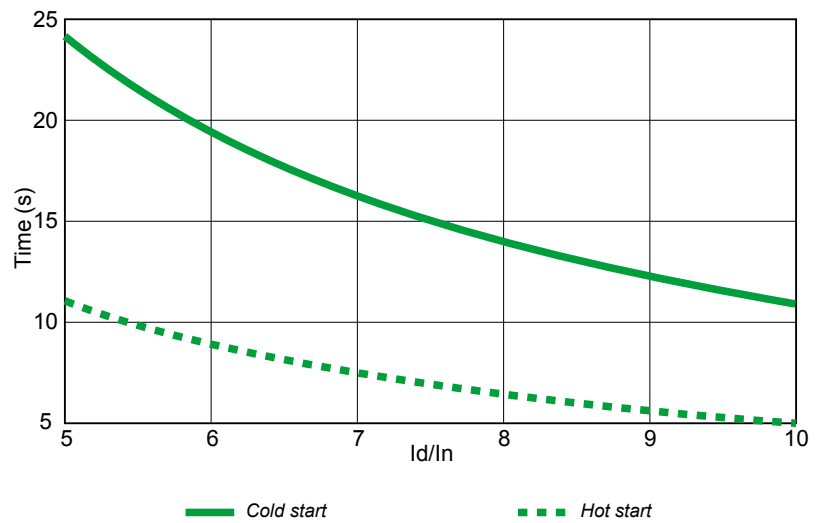

Note: for IP55 motors with frame size ≥ 355 LD, 2 successive cold starts and 1 hot start are allowed (after thermal stabilisation at rated power). A stop of at least 15 minutes must be observed between each successive start.



General

Operation

Power - Torque - Efficiency - Power Factor (Cos φ)

DEFINITIONS

The output power (Pu) at the motor shaft is linked to the torque (M) by the equation:

$$P_u = M \cdot \omega$$

where Pu in W, M in N.m, ω in rad/s and where ω is expressed as a function of the speed of rotation in rpm by the equation:

$$\omega = 2\pi \cdot n / 60$$

The active power (P) drawn from the mains is expressed as a function of the apparent

power (S) and the reactive power (Q) by the equation:

$$S = \sqrt{P^2 + Q^2}$$

(S in VA, P in W and Q in VAR)

The power P is linked to the output power Pu by the equation:

$$P = \frac{P_u}{\eta}$$

where η is the efficiency of the machine. The output power Pu at the motor shaft is expressed as a function of the phase-to-phase mains voltage (U in Volts), of the line current absorbed (I in Amps) by the equation:

$$P_u = U \cdot I \cdot \sqrt{3} \cdot \cos \varphi \cdot \eta$$

where cos φ is the power factor found from the ratio:

$$\cos \varphi = \frac{P}{S}$$

EFFICIENCY

In accordance with the agreements signed at the Rio and Buenos Aires international conferences, The new IMfinity® ranges have been designed to improve efficiency in order to reduce atmospheric pollution (carbon dioxide).

The improved efficiency of low voltage industrial motors (representing around 50% of installed power in industry) has had a large impact on energy consumption.

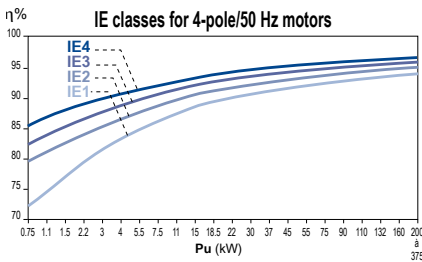

Advantages of improvement in efficiency:

Motor characteristics	Effects on the motor	Customer benefits
Increase in efficiency and in power factor	-	Lower operating costs Longer service life (x2 or 3) Better return on investment
Noise reduction	-	Improved working conditions
Vibration reduction	-	Quiet operation and longer service life of equipment being driven
Temperature reduction	Longer service life of fragile components (insulation system components, greased bearings)	Reduced number of operating incidents and reduced maintenance costs
	Increased capability of instantaneous or extended overloads	Wider field of applications (voltages, altitude, ambient temperature, etc)

General

Operation

Power - Torque - Efficiency - Power Factor (Cos φ)

RATED POWER P_n IN RELATION TO DUTY CYCLE

GENERAL RULE FOR STANDARD MOTORS

$$P_n = \sqrt{\frac{n \times t_d \times [I_D/I_n \times P]^2 + (3600 - n \times t_d)P^2 \times f_{dm}}{3600}}$$

Iterative calculation where:

t_{d(s)} : starting time achieved with motor rated P_(w)

n : number of (equivalent) starts per hour

f_{dm} (OF): operating factor (decimal)

I_D/I_n : current demand for motor rated P

P_{u(w)} : motor output power during the duty cycle using OF (in decimal), operating factor

P_(w) : motor rated power selected for the calculation

Sp = specification

S1	OF = 1 ; n ≤ 6
S2	n = 1 operating life determined by specification (Sp)
S3	OF according to Sp; n ~ 0 (no effect of starting on temperature rise)
S4	OF according to Sp; n according to Sp; t _d , P _u , P according to Sp (replace n with 4n in the above formula)
S5	OF according to Sp; n = n starts + 3 n brakings = 4 n ; t _d , P _u , P as per CdC (replace n with 4n in the above formula)
S6	$P = \sqrt{\frac{\sum^n (P_i^2 \cdot t_i)}{\sum^n t_i}}$
S7	same formula as S5 but OF = 1
S8	at high speed, same formula as in S1 at low speed, same formula as in S5
S9	S8 duty formula after complete description of cycle with OF on each speed
S10	same formula as S6

In addition, see the warning regarding precautions to be taken. Variations in voltage and/or frequency greater than standard should also be taken into account. The application should also be taken into account (general at constant torque, centrifugal at quadratic torque, etc).

DETERMINATION OF THE POWER IN INTERMITTENT DUTY CYCLES FOR ADAPTED MOTORS

RMS POWER IN INTERMITTENT DUTY

This is the rated power absorbed by the driven machine, usually defined by the manufacturer.

If the power absorbed by the machine varies during a cycle, the rms power P is calculated using the equation:

$$P = \sqrt{\frac{\sum^n (P_i^2 \cdot t_i)}{\sum^n t_i}} = \sqrt{\frac{P_1^2 \cdot t_1 + P_2^2 \cdot t_2 + \dots + P_n^2 \cdot t_n}{t_1 + t_2 + \dots + t_n}}$$

if, during the working time the absorbed power is:

P1 for period t1

P2 for period t2

Pn for period tn

Power values lower than 0.5 PN are replaced by 0.5 PN in the calculation of rms power P (no-load operation is a special case).

Additionally, it is also necessary to check that for a particular motor of power PN:

- the actual starting time is at most equal to 5 seconds
- the maximum output of the cycle does not exceed twice the rated output power P
- there is still sufficient accelerating torque during the starting period

Load factor (LF)

Expressed as a percentage, this is the ratio of the period of operating time with a load during the cycle to the total powered-up time during the cycle.

Operating factor (OF)

Expressed as a percentage, this is the ratio of the motor powered-up time during the cycle to the total cycle time, provided that the total cycle time is less than 10 minutes.

Starting class

Class: n = nD + k.nF + k'.ni

nD: number of complete starts per hour
nF: number of electrical braking operations per hour

“Electrical braking” means any braking directly involving the stator winding or the rotor winding:

- Regenerative braking (with frequency drive, multipole motor, etc).
- Reverse-current braking (the most commonly used)
- D.C. injection braking

ni: number of pulses (incomplete starts up to a third of maximum speed) per hour

k and k' are constants determined as follows:

	k	k'
Cage induction motors	3	0.5

- Reversing the direction of rotation involves braking (usually electrical) and starting.
- Braking with Nidec Leroy-Somer electro-mechanical brakes, as with any other brakes that are independent of the motor, does not constitute electrical braking in the sense described above.

General

Operation

Power - Torque - Efficiency - Power Factor (Cos φ)

CALCULATING DERATING

- Input criteria (load)
 - rms power during the cycle = P
 - Moment of inertia related to the speed of the motor: $J_{c/m}$
 - Operating factor = OF
 - Class of starts per hour = n
 - Resistive torque during starting = M_r
 - Motor speed = N

- Selection in catalogue
 - Motor rated power = P_n
 - Starting current I_d , $\cos\phi$
 - Moment of rotor inertia J_m
 - Average starting torque M_{mot}
 - Efficiency at P_n (ηP_n) and at P (ηP)

Calculations

- Starting time:

$$t_d = \frac{\pi}{30} \cdot N \cdot \frac{(J_{c/m} + J_m)}{M_{mot} - M_r}$$

- Cumulative starting time per hour:
 $n \times t_d$

- Energy to be dissipated per hour during starts = sum of the energy dissipated in the rotor (= inertia acceleration energy) and the energy dissipated in the stator during the cumulative starting time per hour:

$$E_d = \frac{1}{2} (J_{c/m} + J_m) \left(\frac{\pi \cdot N}{30} \right)^2 \times n + n \times t_d \sqrt{3} U_d \cos\phi_d$$

- Energy to be dissipated during operation
 $E_f = P \cdot (1 - \eta P) \cdot [(OF) \times 3600 - n \times t_d]$

- Energy that the motor can dissipate at rated power with the Operating Factor for Intermittent Duty.

$$E_m = (OF) \cdot 3600 \cdot P_n (1 - \eta P_n)$$

(The heat dissipated when the motor is at rest can be ignored).

Dimensioning is correct if the following relationship is verified =

$$E_m \geq E_d + E_f$$

If the sum of $E_d + E_f$ is lower than $0.75 E_m$, check whether a motor with the next lowest power rating would be more suitable.

EQUIVALENT THERMAL CONSTANT

The equivalent thermal constant enables the machine cooling time to be predetermined.

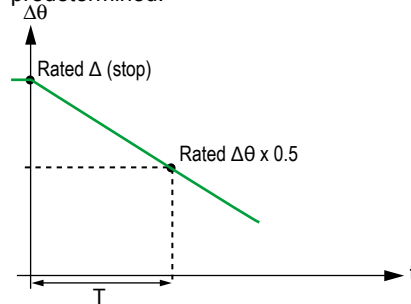

$$\text{Thermal constant} = \frac{T}{\ln 2} = 1.44 T$$

Cooling curve $\Delta\theta = f(t)$

where:

$\Delta\theta$ = temperature rise in S1 duty

T = time taken to go from the nominal temperature rise to half its value

t = time

ln = natural logarithm

TRANSIENT OVERLOAD AFTER OPERATING IN TYPE S1 DUTY CYCLE

At rated voltage and frequency, the motors can withstand an overload of:

1.20 for an OF = 50 %

1.40 for an OF = 10 %

However, it is necessary to ensure that the maximum torque is much greater than 1.5 times the rated torque corresponding to the overload.

IMfinity® 3-phase induction motors - IE2 - IE3 - IE4 - Non IE Efficiency

General

Operation

Use with speed drive

The motors in this catalogue comply with regulation 640/2009, and its modifications, in the ErP directive. For better selection, use and adjustment of the drive parameters, all IMfinity® motors, as defined in the following pages, benefit from a dual nameplate* which means equally good performance can be obtained on a mains supply (non- EU market) as on a drive (EU market).

Best practices Motor-drive systems rules are available in the document part number 5626 (www.leroy-somer.com).

It should also be noted that the regulation requires information to be included on the nameplate stating that a variable speed drive must be used with a class IE2 motor*.

* See example of nameplate in the Identification section.



CEMEP (the European Committee of Manufacturers of Electrical Machines and Power Electronics) decided to create a label to highlight the conformance of motors manufactured by its members with European regulations, thus ensuring the conformance of products released onto the market with the implementing regulation in the ErP directive.

The Nidec Leroy-Somer range of drives is extremely well adapted to all the most demanding constraints of the market.



Electro_Motor.ir

APPLICATIONS AND CHOICE OF SOLUTIONS

In principle, there are three typical types of load. It is essential to determine the speed range and the application torque (or power) in order to select the drive system:

CENTRIFUGAL MACHINES

The torque varies as the square of the speed (or cube of the power). The torque required for acceleration is low (about 20% of rated torque). The starting torque is low.

- Sizing: depends on the power or torque at maximum speed
- Drive selected for normal duty

Typical applications: ventilation, pumping, ...

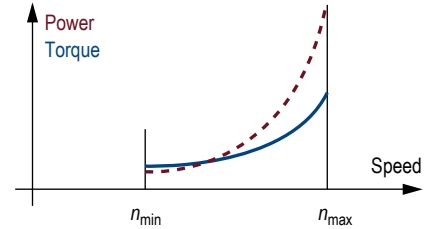

APPLICATIONS WITH CONSTANT TORQUE

The torque remains constant throughout the speed range. The torque required for acceleration may be high, depending on the machine (higher than the rated torque).

- Sizing: depends on the torque required over the entire speed range
- Drive selected for heavy duty

Typical machines: extruders, crushers, gantries, presses, ...

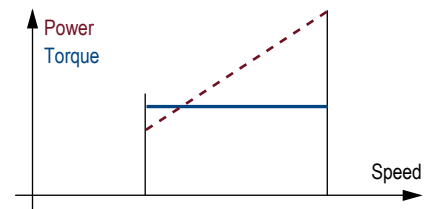

APPLICATIONS WITH CONSTANT POWER

The torque decreases as the speed increases. The torque required for acceleration is no more than the rated torque. The starting torque is at its maximum.

- Sizing: depends on the torque required at minimum speed and the range of operating speeds.
- Drive selected for heavy duty
- An encoder feedback is advisable for improved regulation

Typical machines: winders, machine tool spindles, ...

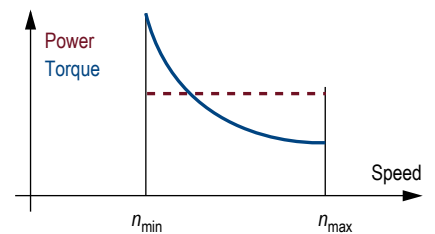

4 QUADRANTS MACHINES

These applications have a torque/speed operating type as described opposite, but the load becomes a driving load in certain stages of the cycle.

- Sizing: see above depending on the load.
- In the case of repetitive braking, install a reinforced insulation system (RIS).
- Drive selection: to dissipate the power from a driving load, it is possible to use a braking resistor, or to send power back to the grid. In the latter case, a regenerative or 4-quadrant drive should be used.

Typical machines: centrifuges, travelling cranes, presses, machine tool spindles, etc

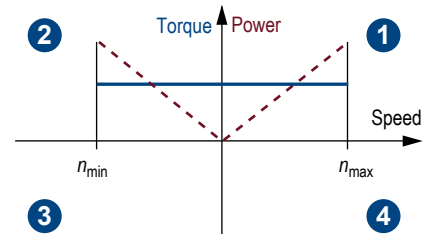

CHOICE OF INVERTER/MOTOR COMBINATION

The curve below expresses the output torque of a 50 Hz motor (2, 4 or 6 poles) supplied by a drive.

For a frequency inverter with power P_N operating at constant power P within a determined range of speeds, it is possible to optimise the choice of motor and its number of poles to give a maximum amount of torque.

Example: the Unidrive M400-034-00056A-3.5 T drive can supply the following motors:
 LSES 90 - 2 p - 2.2 kW - 7.1 N.m
 LSES 100 - 4 p - 2.2 kW - 14.6 N.m
 LSES 112 - 6 p - 2.2 kW - 21.9 N.m

The choice of the motor and inverter combination will therefore depend on the application.

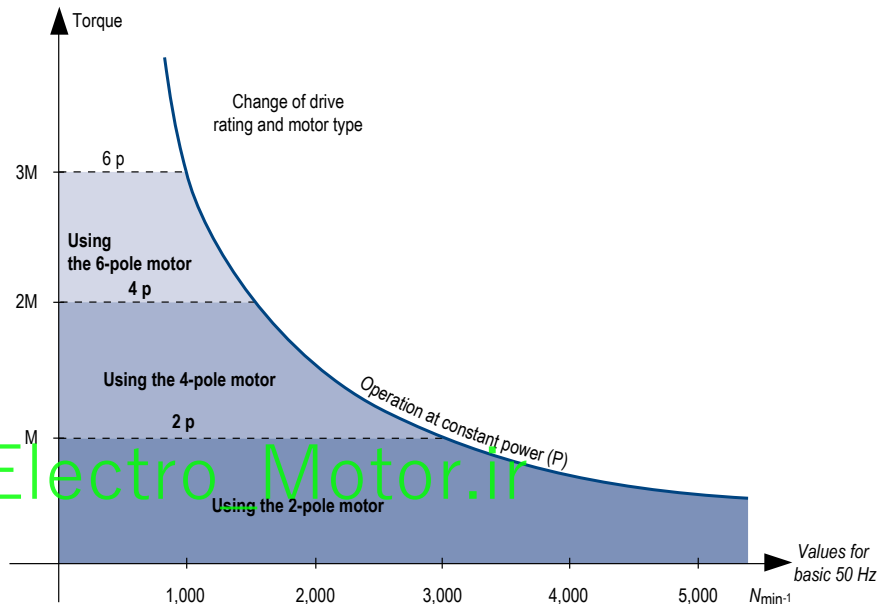

USING THE MOTOR AT CONSTANT TORQUE FROM 0 to 87 HZ

Using motors with a Δ connection in conjunction with a frequency inverter increases the constant torque range from 50 to 87 Hz, which can increase the power by the same ratio.

The size of the frequency inverter is determined by the current value in 230 V and programmed with a voltage/frequency ratio of 400 V, 87 Hz.

Example of selection with 4 poles:

- For constant torque of 195 Nm from 750 to 2600 min⁻¹:
- Selection: 30 kW 4P LSES motor + 100 A drive

CAUTION: Max. mechanical speed by frame size to be complied with.

**Characteristics of motors on drives
230 V Δ connection 400 V 50 Hz supply**

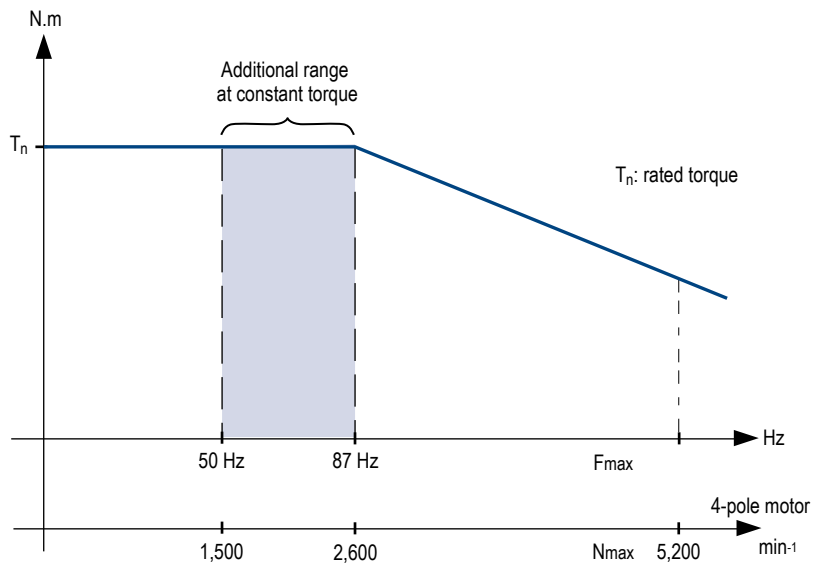
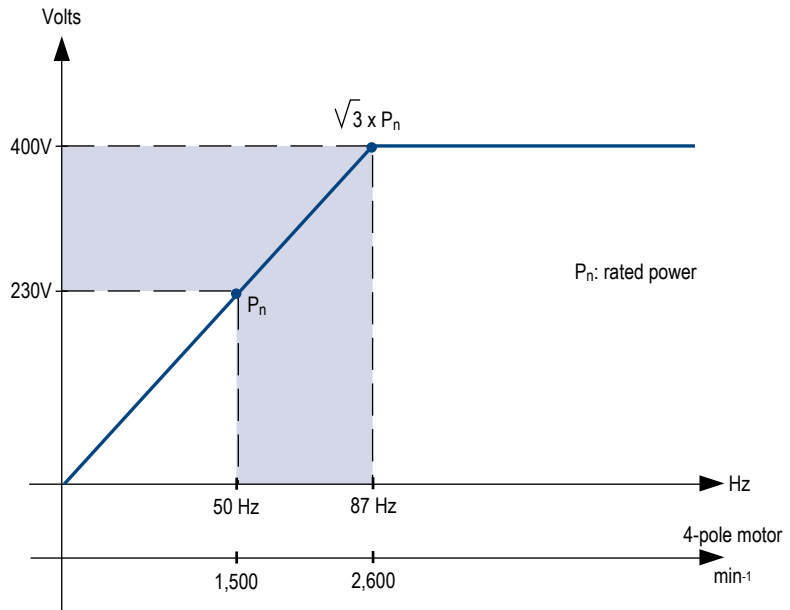

General
Operation
Noise level

NOISE EMITTED BY ROTATING MACHINES

In a compressible medium, the mechanical vibrations of an elastic body create pressure waves which are characterized by their amplitude and frequency. The pressure waves constitute an audible noise if they have a frequency of between 16 Hz and 16,000 Hz.

Noise is measured by a microphone linked to a frequency analyser. Measurements are taken in an anechoic chamber on machines at no-load, and a sound pressure level L_p or a sound power level L_w can then be established. Measurement can also be carried out in situ on machines which may be on-load, using an acoustic intensity meter which can differentiate between sound sources and identify the sound emissions from the machine.

The concept of noise is linked to hearing. The auditory sensation is determined by integrating weighted frequency components with isosonic curves (giving a sensation of constant sound level) according to their intensity.

The weighting is carried out on sound meters using filters whose bandwidth takes into account, to a certain extent, the physiology of the human ear:

Filter A: used for low and medium noise levels. High attenuation, narrow bandwidth.

Filter B: used for very high noise levels. Wide bandwidth.

Filter C: very low attenuation over the whole of the audible frequency range.

A few basic definitions:
The unit of reference is the bel, and the sub-multiple decibel dB is used here.

Sound pressure level in dB
 $L_p = 20 \log_{10} \left(\frac{P}{P_0} \right)$ $P_0 = 2 \cdot 10^{-5} \text{ Pa}$

Sound power level in dB
 $L_w = 10 \log_{10} \left(\frac{P}{P_0} \right)$ $P_0 = 10^{-12} \text{ W}$

Sound intensity level in dB
 $L_w = 10 \log_{10} \left(\frac{I}{I_0} \right)$ $I_0 = 10^{-12} \text{ W/m}^2$

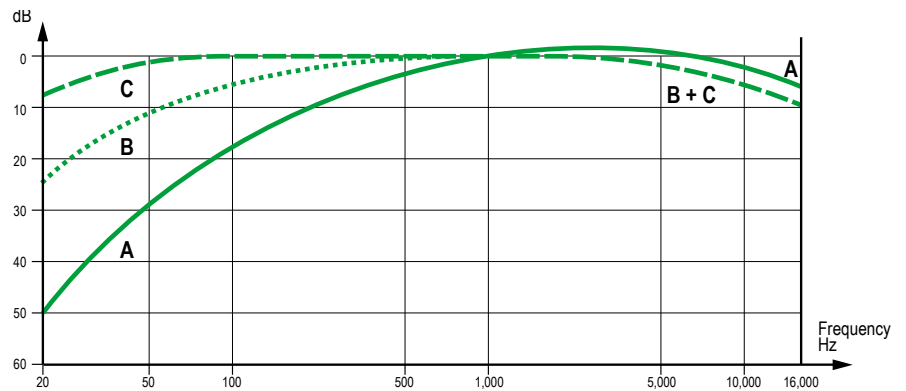

CORRECTION OF MEASUREMENTS

For differences of less than 10 dB between 2 sound sources or where there is background noise, corrections can be made by addition or subtraction using the rules below.

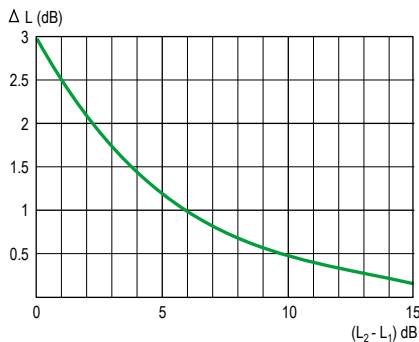

Addition of levels

If L_1 and L_2 are the separately measured levels ($L_2 \geq L_1$), the resulting sound level L_R will be obtained by the formula:

$$L_R = L_2 + \Delta L$$

ΔL is found by using the curve above.

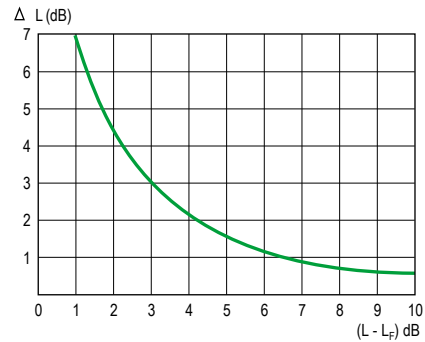

Subtract

This is most commonly used to eliminate background noise from measurements taken in a "noisy" environment.

If L is the measured level and L_F the background noise level, the actual sound level L_R will be obtained by the calculation:

$$L_R = L - \Delta L$$

ΔL is found by using the curve above.

Electro_Motor.ir *This method is the one normally used for measuring sound power and pressure levels. It is also an integral part of sound intensity measurement.

IMfinity® 3-phase induction motors - IE2 - IE3 - IE4 - Non IE Efficiency

General

Operation

Weighted sound level [dB(A)]

Under IEC 60034-9, the guaranteed values are given for a machine operating at no-load under normal supply conditions (IEC 60034-1), in the actual operating position, or sometimes in the direction of rotation as specified in the design.

This being the case, standardized sound power level limits are shown for the values obtained for the machines described in this catalogue.

(Measurements were taken in conformity with standard ISO 1680).

Expressed as sound power level (L_w) according to the standard, the level of sound is also shown as sound pressure level (L_p) in the selection data.

The maximum standard tolerance for all these values is + 3 dB(A).



The noise levels of the motors in this catalogue are indicated in the selection tables.

Electro_Motor.ir

The machines in this catalogue are in vibration class level A

VIBRATION LEVELS - BALANCING

Inaccuracies due to construction (magnetic, mechanical and air-flow) lead to sinusoidal (or pseudo sinusoidal) vibrations over a wide range of frequencies. Other sources of vibrations disturb operation: bad fastening of the frame, incorrect coupling, bushing misalignment, etc.

We shall first of all look at the vibrations emitted at the operating frequency, corresponding to an unbalanced load, whose amplitude swamps all other frequencies and on which the dynamic balancing of the mass in rotation has a decisive effect.

Under standard ISO 8821, rotating machines can be balanced with or without a key or with a half-key on the shaft extension.

Standard ISO 8821 requires the balancing method to be marked on the shaft extension as follows:

- Half-key balancing: letter H
- Full key balancing: letter F
- No-key balancing: letter N

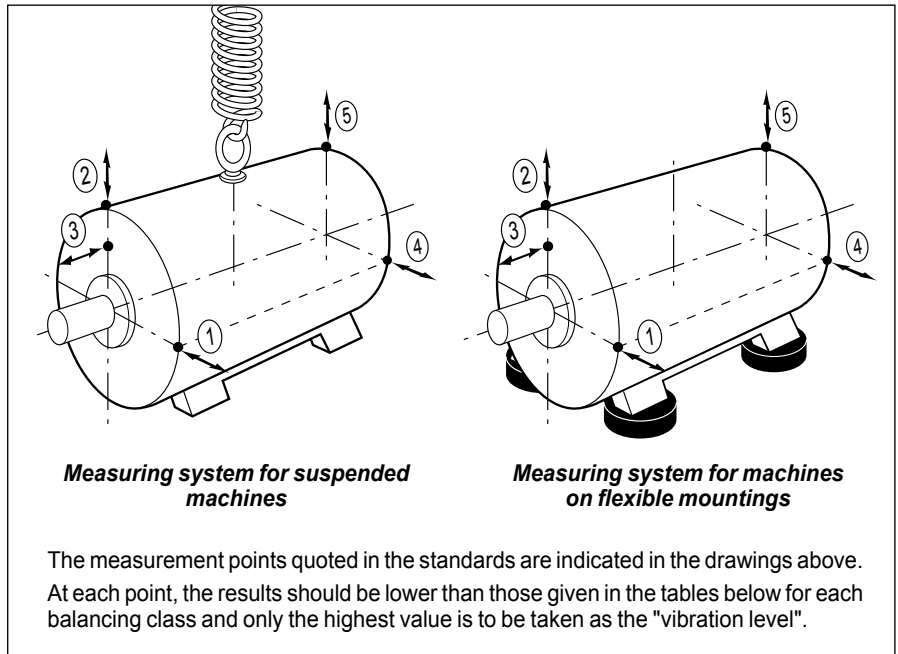

IMfinity® motors are half-key balanced as standard. Any coupling element (pulley, coupling sleeve, slip-ring, etc.) must therefore be balanced accordingly. Check the motor nameplate for balancing information.

MEASURED MAGNITUDE

The vibration speed can be chosen as the variable to be measured. This is the speed at which the machine moves either side of its static position. It is measured in mm/s.

As the vibratory movements are complex and non-harmonic, it is the root mean square (rms) value of the speed of vibration which is used to express the vibration level.

Measured are the vibratory displacement amplitude (in µm) or vibratory acceleration (in m/s²). If the vibratory displacement is measured against frequency, the measured value decreases with the frequency: high-frequency vibrations cannot be measured.

If the vibratory acceleration is measured, the measured value increases with the frequency: low-frequency vibrations (unbalanced loads) cannot be measured here.

The rms speed of vibration is the variable chosen by the standards.

However, if preferred, the table of vibration amplitudes may still be used (for measuring sinusoidal and similar vibrations).

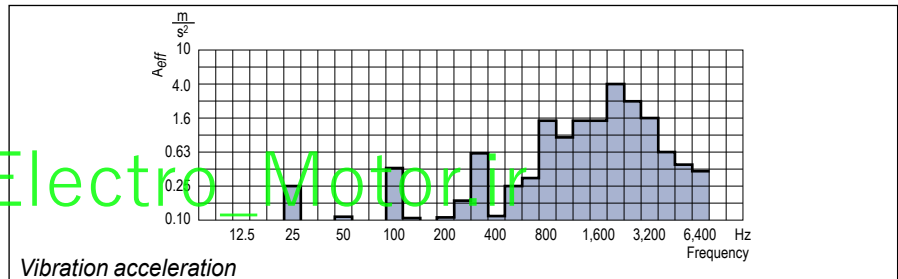
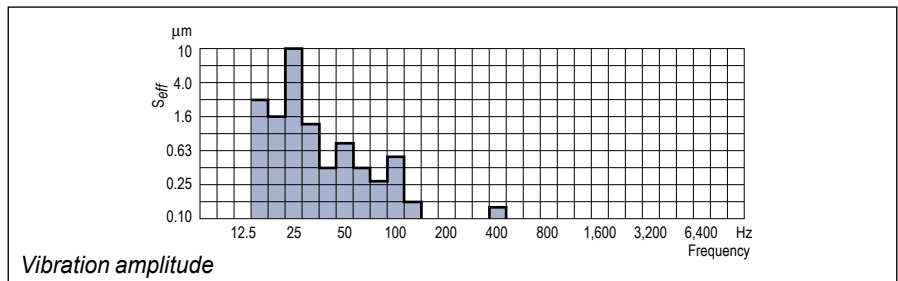
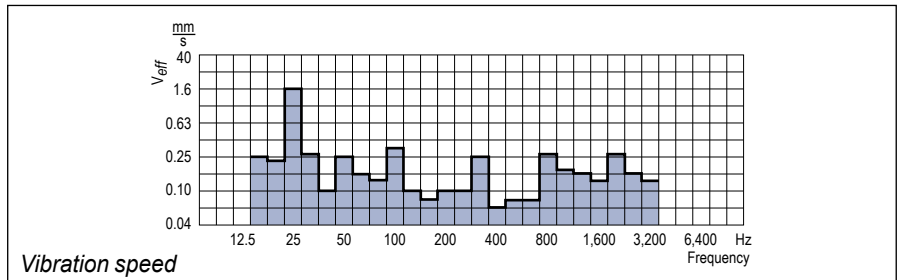

Electro_Motor.ir

MAXIMUM VIBRATION MAGNITUDE LIMITS (RMS VALUES), IN TERMS OF DISPLACEMENT, SPEED AND ACCELERATION FOR A FRAME SIZE H (IEC 60034-14)

Vibration level	Frame size H (mm)								
	$56 \leq H \leq 132$			$132 < H \leq 280$			$H > 280$		
	Displacement μm	Speed mm/s	Acceleration m/s^2	Displacement μm	Speed mm/s	Acceleration m/s^2	Displacement μm	Speed mm/s	Acceleration m/s^2
A	25	1.6	2.5	35	2.2	3.5	45	2.8	4.4
B	11	0.7	1.1	18	1.1	1.7	29	1.8	2.8

For large machines and special requirements with regard to vibration, balancing can be carried out *in situ* (finished assembly). Prior consultation is essential, as the machine dimensions may be modified by the necessary addition of balancing disks mounted on the shaft extensions.

THERMAL PROTECTION

Motors are protected by a manual or automatic overcurrent relay, placed between the isolating switch and the motor. This relay may in turn be protected by fuses.

These protection devices provide total protection of the motor against non-transient overloads. If a shorter reaction time is required, if you want to detect transient overloads, or if you wish to

monitor temperature rises at “hot spots” in the motor or at strategic points in the installation for maintenance purposes, it would be advisable to install heat sensors at sensitive points. The various types are shown in the table below, with a description of each. It must be emphasized that under no circumstances can these sensors be used to carry out direct regulation of the motor operating cycles.

The motors in this catalog are equipped with PTC sensors from frame size ≥ 160 mm

BUILT-IN INDIRECT THERMAL PROTECTIONS

Type	Operating principle	Operating curve	Breaking capacity (A)	Protection provided	Mounting Number of devices*
Normally closed thermal protection PTO	Bimetallic strip, indirectly heated, with normally closed (NC) contact 		2.5 A at 250 V with $\cos \phi$ 0.4	General monitoring for non-transient overloads	Mounting in control circuit 2 in series
Normally open thermal protection PTF	Bimetallic strip, indirectly heated, with normally open (NO) contact 		2.5 A at 250 V with $\cos \phi$ 0.4	General monitoring for non-transient overloads	Mounting in control circuit 2 in parallel
Positive temperature coefficient thermistor PTC	Non-linear variable resistor, indirectly heated 		0	General monitoring for transient overloads	Mounted with associated relay in control circuit 3 in series
Thermocouples T ($T < 150$ °C) Copper Constantan K ($T < 1000$ °C) Copper-nickel	Peltier effect		0	Continuous surveillance of hot spots at regular intervals	Mounted in control boards with associated reading equipment (or recorder) 1 per hot spot
Platinum temperature sensor PT 100	Linear variable resistor, indirectly heated		0	high accuracy continuous surveillance of key hot spots	Mounted in control boards with associated reading equipment (or recorder) 1 per hot spot
Temperature sensor PT 1000	Resistance depending on the winding temperature		0	high accuracy continuous surveillance of key hot spots	Mounted in control boards with associated reading equipment (or recorder) 1 per hot spot

- NRT: nominal running temperature.

- The NRTs are chosen according to the position of the sensor in the motor and the temperature rise class.

* The number of devices relates to the winding protection.

FITTING THERMAL PROTECTION

- PTO or PTF, in the control circuits
- PTC, with relay, in the control circuits
- PT 100 or thermocouples, with reading equipment or recorder, in the installation control panel for continuous surveillance

ALARM AND EARLY WARNING

All protective equipment can be backed up by another type of protection (with different NRTs): the first device will then act as an early warning (light or sound signals given without shutting down the power circuits) and the second device will be the alarm (shutting down the power circuits).

BUILT-IN DIRECT THERMAL PROTECTIONS

For low rated currents, bimetallic strip-type protection may be used. The line current passes through the strip, which shuts down or restores the supply circuit as necessary. The design of this type of protection allows for manual or automatic reset.

General

Operation

Starting methods for induction motors

The two essential parameters for starting cage induction motors are:

- starting torque,
- starting current.

These two parameters and the resistive torque determine the starting time.

These three characteristics arise from the construction of cage induction motors. Depending on the driven load, it may be necessary to adjust these values to avoid torque surges on the load or current surges in the supply. There are essentially five different types of supply, which are:

- D.O.L. starting
- star/delta starting
- soft starting with auto-transformer
- soft starting with resistors
- electronic starting

The tables on the next few pages give the electrical outline diagrams, the effect on the characteristic curves, and a comparison of the respective advantages of each mode.

MOTORS WITH ASSOCIATED ELECTRONICS

Electronic starting modes control the voltage at the motor terminals throughout the entire starting phase, giving very gradual smooth starting.

DIGISTART D2 ELECTRONIC STARTER

This simple, compact electronic starter enables three-phase induction motors to be started smoothly by controlling their acceleration. It incorporates motor protection.



- **18 to 200 A range**
 - **Integrated by-pass:** ease of wiring
 - Simplicity and speed of setup
- All settings configured with just seven selector switches
- **Flexibility**
 - Mains supply voltages
200 - 440 VAC & 200 - 575 VAC

• **Starting and stopping modes:**

- Current limit
- Current ramp
- Deceleration control
- Communication
- Modbus RTU, DeviceNet, Profibus, Ethernet/IP, Profinet, Modbus TCP, USB, display console
- Management of pumping functions

DIGISTART D3 ELECTRONIC STARTER

Using the latest electronic control technologies to manage transient phases, the DIGISTART D3 range combines simplicity and user-friendliness while offering the user a high-performance, communicating electronic starter, and can achieve substantial energy savings.



- Range from 23 to 1600A / 400V or 690V
- Integrated bypass up to 1000 A:
- Compact design Up to 60% space saving.
- Energy saving.
- Reduced installation costs.

• **Advanced control**

- Starting and stopping adapt to the load automatically.
- Automatic parameter optimisation by gradually learning the types of start.
- Special deceleration curve for pumping applications which derives from more than 15 years of Nidec Leroy-Somer's experience and expertise.

• **High availability**

- Able to operate with only two power components operational.
- Protection devices can be disabled to implement forced run mode (smoke extraction, fire pump, etc.).

• **Total protection**

- Continuous thermal modelling for maximum motor protection (even in the event of a power cut).

- Trips on configurable power thresholds
- Control of phase current imbalance.
- Monitoring of motor temperatures and the environment with PTC or PT 100.

• **Other features**

- Installation trips in the event of an earth fault
- Connection to "Δ" motor (6-wire)
- Starter size at least one rating lower
- Automatic detection of motor connection
- Ideal for replacing Y/Δ starters

• **Communication**

Modbus RTU, DeviceNet, Profibus, Ethernet/IP, Profinet, Modbus TCP, USB.

• **Simplicity of setup**

- 3 parameter-setting levels
- Preset configurations for pumps, fans, compressors, etc
- Standard: access to the main parameters
- Advanced menu: access to all data.
- Storage
- Time-stamped log of trips
- Energy consumption and operating conditions
- Latest modifications
- Simulate operation by forcing control
- Display the state of the inputs/outputs
- Counters: running time, number of starts, etc.

INTEGRATED VARIABLE SPEED MOTOR

These motors (Commander ID300 type) are designed and developed with built-in electronics.

Characteristics:

- $0.25 \leq P \leq 7.5$ kW
- 50/60 Hz
- Frequency range: 10 to 150 Hz

• **Starting on variable speed drive**

One of the advantages of variable speed drives is that loads can be started without a current surge on the mains supply, since starting is always performed with no voltage or frequency at the motor terminals.

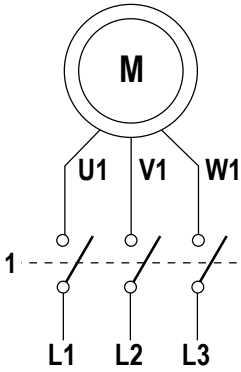
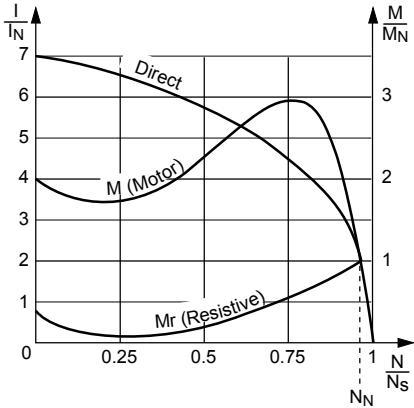
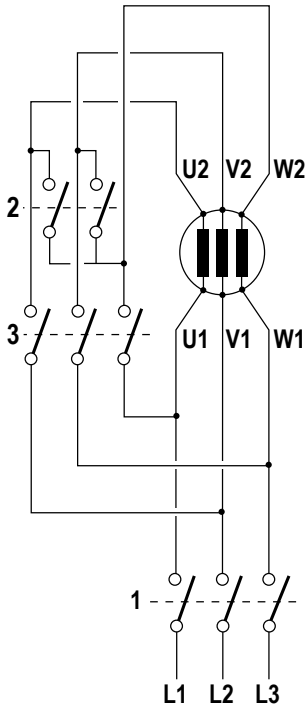
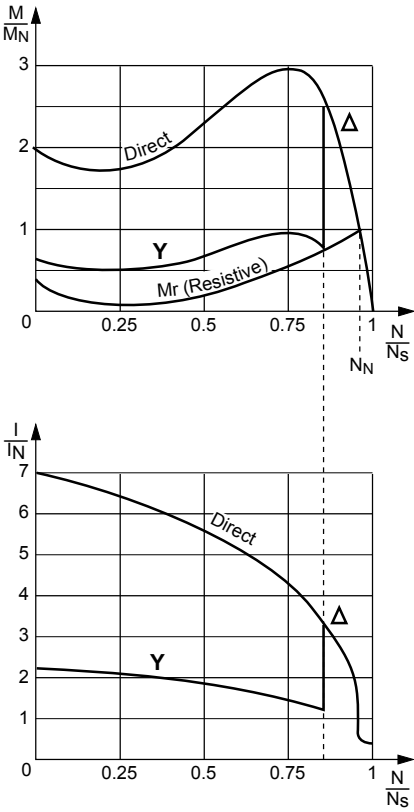
Mode	Outline diagram	Characteristic curves	Number of steps	Starting torque	Starting current	Advantages
D.O.L.			1	M_D	I_D	<ul style="list-style-type: none"> Simplicity of the equipment High torque Minimum starting time
Star-Delta			2	$M_D/3$	$I_D/3$	<ul style="list-style-type: none"> Starting current divided by 3 Simple equipment 3 contactors including 1 two-pole

Mode	Outline diagram	Characteristic curves	Number of steps	Starting torque	Starting current	Advantages
<p>Soft starting with autotransformer</p>			<p>$n \geq 3$</p>	<p>$K^2 \cdot M_D$</p> <p>$K = \frac{U_{starting}}{U_n}$</p>	<p>$K^2 \cdot I_D$</p>	<p>Can be used to select the torque</p> <p>Current reduction proportional to that for the torque</p> <p>No power cut-off</p>
<p>Soft starting with resistors</p>			<p>n</p>	<p>$K^2 \cdot M_D$</p> <p>$K = \frac{U_{starting}}{U_n}$</p>	<p>$K \cdot I_D$</p>	<p>Can be used to select the torque or the current</p> <p>No power cut-off</p> <p>Modest additional cost (1 contactor per step)</p>

Electro_Motor.ir

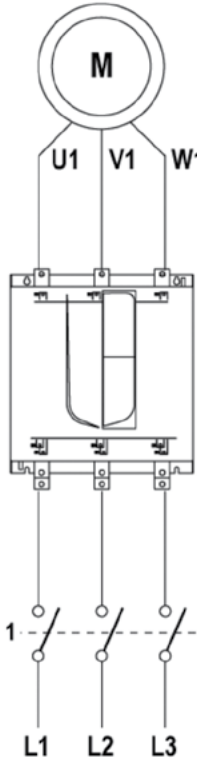
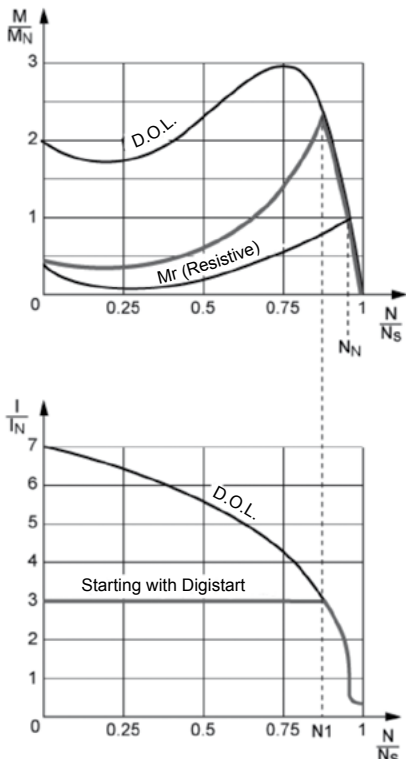
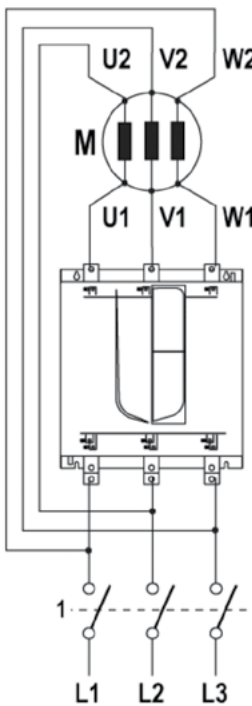
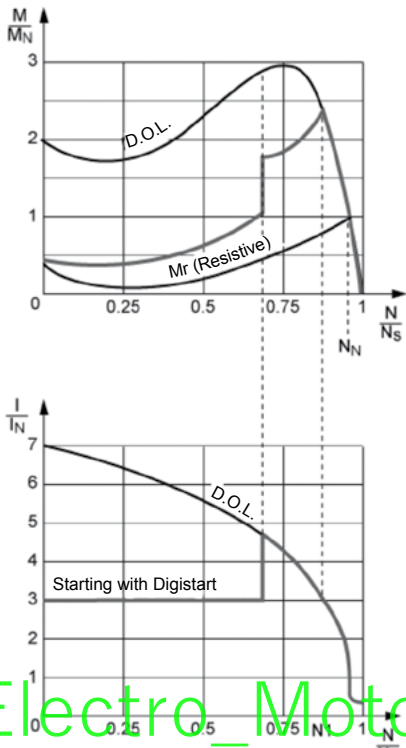
Mode	Outline diagram	Characteristic curves	Number of steps	Starting torque	Starting current	Advantages
<p>DIGISTART D2 & D3</p>				$K^2 M_D$	$K I_D$	<ul style="list-style-type: none"> Adjustable on site Choice of torque and current No power cut-off Smooth starting Compact size No maintenance High number of starts Digital Integrated motor and machine protection Serial link
<p>DIGISTART D3 mode «6-wire»</p>				$K^2 M_D$	$K I_D$	<ul style="list-style-type: none"> Same advantages as the above DIGISTART Current reduced by 35% Suitable for retrofitting on installations Y-D With or without bypass

Electro_Motor.ir

General
Operation
Braking

GENERAL

The braking torque equals the torque developed by the motor increased by the resistant torque of the driven machine.

$$C_f = C_m + C_r$$

C_f = braking torque

C_m = motor torque

C_r = resistive torque

Braking time, ie. the time required for an induction motor to change from speed N to stop, is calculated by the formula:

$$T_f = \frac{\pi \cdot J \cdot N}{30 \cdot C_f(\text{moy})}$$

T_f (in s) = braking time

J (in kgm²) = moment of inertia

N (in min⁻¹) = speed of rotation

C_f (av) (in N.m) = average braking torque during the time period

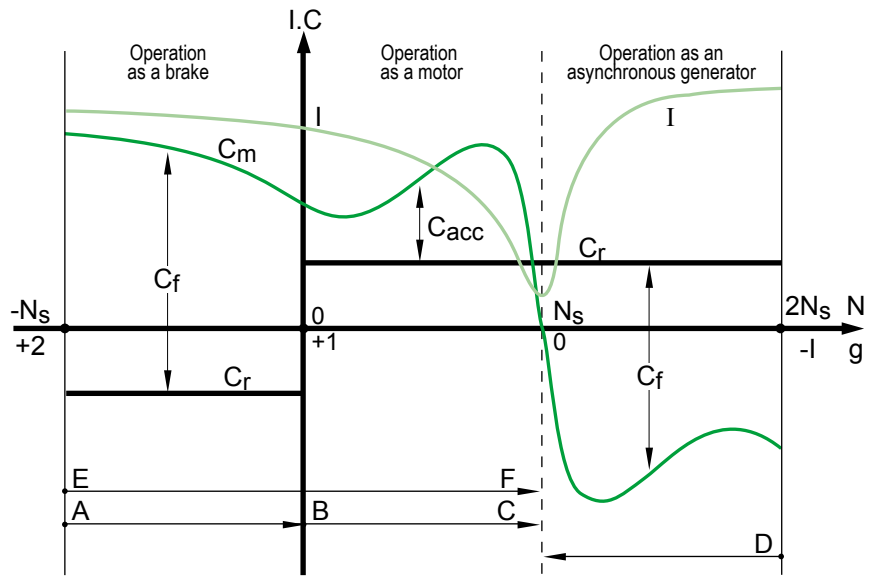

Curves $I = f(N)$, $C_m = f(N)$, $C_r = f(N)$, in the motor's starting and braking zones.

- | | |
|--------------------------|------------------------------|
| I = current absorbed | g = slip |
| C = torque value | N_s = synchronous speed |
| C_f = braking torque | AB = reverse current braking |
| C_r = resistive torque | BC = starting, acceleration |
| C_m = motor torque | DC = regenerative braking |
| N = speed of rotation | EF = reversal |

REVERSE-CURRENT BRAKING

This method of braking is obtained by reversing two of the phases.

In general, an isolator disconnects the motor from the supply at the time the speed changes to N=0.

In cage induction motors, the average braking torque is generally greater than the starting torque.

Braking torque varies in different types of machine, as it depends on the rotor cage construction.

This method of braking involves a large amount of absorbed current, more or less constant and slightly higher than the starting current.

Thermal stresses during braking are three times higher than during acceleration.

Accurate calculations are required for repetitive braking.

Note: The direction of rotation of a motor is changed by reverse-current braking and restarting.

Thermically, one reversal is the equivalent of 4 starts. Care must therefore be taken when choosing a machine.

D.C. INJECTION BRAKING

Operating stability can be a problem when reverse-current braking is used, due to the flattening out of the braking torque curve in the speed interval (0, - N_s).

There is no such problem with D.C. injection braking: this can be used on both cage induction and slip-ring motors.

With this braking method, the induction motor is connected to the mains and braking occurs when the A.C. voltage is cut off and D.C. voltage is applied to the stator.

There are four different ways of connecting the windings to the D.C. voltage.

The D.C. voltage applied to the stator is usually supplied by a rectifier plugged into the mains.

Thermal stresses are approximately three times lower than for reverse-current braking.

The shape of the braking torque curve in the speed interval (0, - N_s) is similar to that of the curve $T_m = f(N)$ and is obtained by changing the abscissa variable to $N_f = N_s - N$.

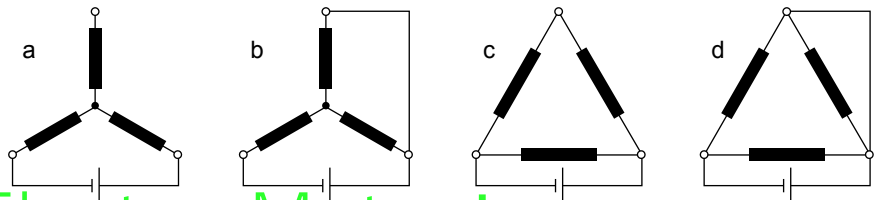

Electro_Motor.ir
Motor winding connections for D.C. voltage

General Operation Braking

The braking current is calculated using the formula:

$$I_f = k1_i \times I_d \sqrt{\frac{C_f - C_{f0}}{k2 - C_d}}$$

The values of k1 according to the 4 couplings are:

$$\begin{aligned} k1_a &= 1.225 & k1_c &= 2.12 \\ k1_b &= 1.41 & k1_d &= 2.45 \end{aligned}$$

The braking torque can be found by:

$$C_f = \frac{\pi \cdot J \cdot N}{30 \cdot T_f}$$

In the formulae above:

- If (in A) = direct current for braking
- Id (in A) = starting current in the phase
= $\frac{1}{\sqrt{3}}$ Id as per catalogue (for Δ connection)
- Cf (in N.m) = average braking torque during the time period (Ns, N)
- Cf (in N.m) = external braking torque
- Cd (in N.m) = starting torque
- J (in kgm²) = total moment of inertia at motor shaft
- N (in min⁻¹) = speed of rotation
- Tf (in s) = braking time
- k1i = numerical factors for connections a, b, c and d in the diagram
- k2 = numerical factors taking account of the average braking torque (k2 = 1.7)

The D.C. voltage to be applied to the windings is calculated by:

$$U_f = k3_i \cdot k4 \cdot I_f \cdot R1$$

k3 values for the four diagrams are as follows:

- k3_a = 2
- k3_b = 1.5
- k3_c = 0.66
- k3_d = 0.5
- Uf (in V) = D.C. voltage for braking
- If (in A) = direct current for braking
- R1 (in Ω) = stator phase resistance at 20°C
- k3i = numerical factors for diagrams a, b, c and d
- k4 = numerical factor taking account of the temperature rise in the motor (k4 = 1.3)

MECHANICAL BRAKING

Electromechanical brakes (D.C. or A.C. field excitation) can be fitted at the nondrive end of the motor.

For further details, see our "Brake motors" catalogue.

REGENERATIVE BRAKING

This is the braking method applied to multi-speed motors when changing down to lower speeds. This procedure cannot be used to stop the motor.

Thermal stresses are approximately equal to those occurring when motors with Dahlander connections are started at the lower rated speed (speed ratio 1 : 2).

With the motor at the lower speed, working as an asynchronous generator, it develops very high braking torque in the speed interval (2Ns, Ns).

The maximum braking torque is slightly higher than the starting torque of the motor at the lower speed.

DECELERATION BRAKES

For safety reasons, deceleration brakes are fitted at the rear of motors used on hazardous machines (for example, where cutting tools may come into contact with the operator).

The range of brakes is determined by its braking torques:

2.5 - 4 - 8 - 16 - 32 - 60 N.m

The appropriate brake is selected in the factory according to the number of motor poles, the driven inertia, the number of brakings per hour and the required braking time.



General

Operation

Operation as an asynchronous generator

GENERAL

The motor operates as an asynchronous generator each time the load becomes a driving load and the rotor speed exceeds the synchronous speed (N_s).

This can be induced either voluntarily, as in the case of electric power stations (water or wind power, etc) or involuntarily, caused by factors linked to the application (downward movement of crane hooks or blocks, inclined conveyors, etc).

OPERATING CHARACTERISTICS

The diagram opposite shows the various operations of an asynchronous machine in relation to its slip (g) or its speed (N).

Example: Let us consider an induction motor of 45 kW, 4 poles, 50 Hz at 400 V. As a rough estimate, its characteristics as an asynchronous generator can be deduced from its rated characteristics as a motor, by applying the rules of symmetry.

If more precise values are required, the manufacturer should be consulted.

In practice, it is confirmed that the same machine, operating as a motor and as a generator with the same slip, has approximately the same losses in both cases, and therefore virtually the same efficiency.

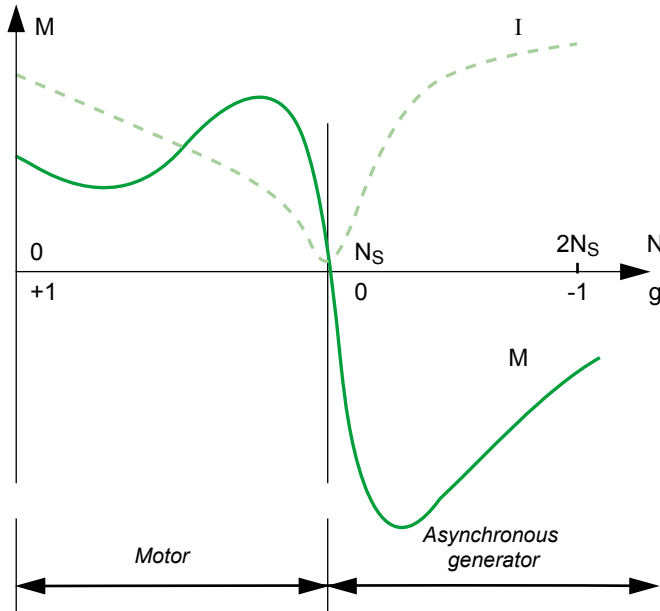

Characteristics	Motor	AG
Synchronism speed (min^{-1})	1500	1500
Rated speed (min^{-1})	1465	1535
Rated torque (m.N)	+ 287	- 287
Rated current under 400 V (A)	87 A (absorbed)	87 A (supplied)

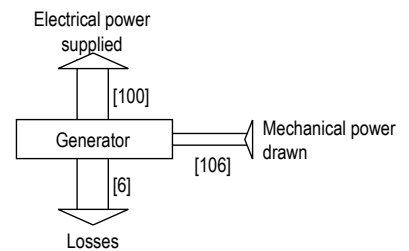
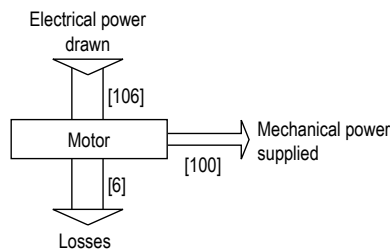

CONNECTION TO A POWERFUL MAINS SUPPLY

It is assumed that the machine stator is connected to a powerful electrical mains supply (usually the national grid), ie. a mains supply provided by a generator which regulates the power to at least twice that of the asynchronous generator.

Under these conditions, the mains supply imposes its own voltage and frequency on the asynchronous generator. Furthermore, it supplies it automatically with the reactive energy necessary for all its operating conditions.

CONNECTION - DISCONNECTION

Before connecting the asynchronous generator to the mains supply, it is necessary to ensure that the direction of phase rotation of the asynchronous generator and the mains supply are in the same order.

- To connect an asynchronous generator to the mains supply, it should be accelerated gradually until it reaches its synchronous speed N_s . At this speed, the machine torque is zero and the current is minimal.

This is an important advantage of asynchronous generators: as the rotor is not polarised until the stator is powered up, it is not necessary to synchronise the mains supply and the machine when they are connected.

However, there is a phenomenon affecting the connection of asynchronous generators which, in some cases, can be a nuisance: the rotor of the asynchronous generator, although not energised, still has some residual magnetism.

On connection, when the magnetic flux created by the mains supply and that caused by the rotor residual magnetism are not in phase, the stator experiences a very brief current peak (one or two halfwaves), combined with an instantaneous overtorque of the same duration.

- Disconnecting the asynchronous generator from the mains supply does not pose any particular problem.

As soon as the machine is disconnected, it becomes electrically inert since it is no longer energised by the mains supply. It no longer brakes the driving machine, which should therefore be stopped to avoid reaching overspeed.

Reactive power compensation

To limit the current in the lines and the transformer, the asynchronous generator can be compensated by restoring the power factor of the installation to the unit, using a bank of capacitors.

In this case, the capacitors are only inserted at the terminals of the asynchronous generator once it has been connected, to avoid self-energisation of the machine due to the residual magnetism during speed pick up. For a 3-phase low voltage asynchronous generator, 3-phase or single-phase capacitors in delta connection are used.

Electrical protection and safety

There are two protection and safety categories:

- those which relate to the mains
- those which relate to the set and its generator

The major mains protection devices monitor:

- maximum-minimum voltage
- maximum-minimum frequency
- minimum power or energy feedback (operating as a motor)
- generator connection fault

The protection devices for the set are:

- stop on detection of racing start
- stop on detection of lubrication faults
- thermal magnetic protection of the generator, usually with probes in the winding.

POWER SUPPLY FOR AN ISOLATED NETWORK

This concerns supplying a consuming network which does not have another generator of sufficient power to impose its voltage and frequency on the asynchronous generator.

REACTIVE POWER COMPENSATION

In the most common case, reactive energy must be supplied:

- to the asynchronous generator,
- to the user loads which consume it.

To supply both of these consumption types with reactive energy, a reactive energy source of suitable power is connected in parallel on the circuit. This is usually a bank of capacitors with one or more stages which may be fixed, manually adjusted (using notches) or automatically adjusted. Synchronous capacitors are now rarely used.

Example: In an isolated network with power consumption of 50 kW where $\cos \varphi = 0.9$ (and $\tan \varphi = 0.49$), supplied by an asynchronous generator with $\cos \varphi$ of 0.8 at 50 kW (and $\tan \varphi = 0.75$), it is necessary to use a bank of capacitors which supplies: $(50 \times 0.49) + (50 \times 0.75) = 62$ kvar.



General

Electrical and mechanical data Identification

INFORMATION PLATES

The information plate identifies the motors, indicate the main performance and show compatibility of the motor concerned with the main standards and concerning them.

All motors in this catalogue with a power between 0.75 and 375 kW are fitted with two information plates: one indicating the motor's performance when supplied by the grid, and the other the motor's performance when supplied through an inverter.

The following table provides a clear vision of compliance of the motors with the different European and North- American regulations and standards.

		Plate marking	CE (IE2 or IE3)	cURus	cCSAus	CSAE	ee (CC055B) only IE3	NEMA Premium only IE3	EAC
Aluminium motors LS / LSES	Power < 7.5 kW	2 & 4 P	Standard	Standard	Option	Option	Standard ¹	Standard ¹	Option
		6 P	Standard	Standard	Option	Option	Option	Option	Option
	Power ≥ 7.5 kW	2 & 4 P	Standard	Standard	Standard	Standard	Standard	Standard	Option
		6 P	Standard	Standard	Standard	Option	Option	Option	Option
FLSES cast iron motors	Power > 0.75 kW	2, 4 & 6 P	Standard	Standard	-	-	-	-	Option
PLSES IP 23 Drip-proof motors	Power > 55 kW	2 & 4 P	Standard	Standard	-	-	-	-	Option

1. except 2 P: 1.8 kW, 3 kW, 3.7 kW and 4 P: 0.9 kW, 1.8 kW, 2.2 kW = option

Option: available upon request. In certain cases, may result in a modification or specific dimensioning of the motor.

DEFINITION OF SYMBOLS USED ON NAMEPLATES



Main supply plate:

MOT 3 ~ : three-phase A.C. motor
LSES : series
200 : frame size
LU : housing symbol
T : impregnation index

Motor no.

789456 : motor batch number
F : month of production
14 : year of production
001 : serial number
IE3 : efficiency class
93.6% : efficiency at 4/4 load

IP55 IK08 : degree of protection
Ins. cl. F : insulation class F
40°C : ambient operating temperature
S1 : duty (operating) factor
kg : weight
V : supply voltage
Hz : supply frequency
min⁻¹ : revolutions per minute (rpm)
kW : rated output power
cos φ : power factor
A : rated current
Δ : delta connection
Y : star connection

Bearings

DE : drive end
 drive end bearing
NDE : non drive end bearing
 Bearing on end opposite the drive
g : amount of grease at each regreasing (in g)
h : regreasing interval (in hours)
POLYREX EM103 : type of grease
 : vibration level
 : balancing mode

Please quote when ordering spare parts

Inverter supply plate:

Inverter settings : parameter setting the frequency inverter
Motor performance : torque available on the motor shaft in % rated torque at the plate frequencies
Min. Fsw (kHz) : minimum cut-off frequency acceptable for the motor
Nmax (min⁻¹) : maximum mechanical speed acceptable for the motor

Electro_Motor.ir

IMfinity® 3-phase induction motors - IE2 - IE3 - IE4 - Non IE Efficiency

General

Electrical and mechanical data

Identification

INFORMATION PLATES LSES ALUMINIUM MOTORS

IE3 power ≥ 7.5 kW*

Main supply plate

3~4P LSES200LU T 2019
N° 123456A19 001 IP55 IK08 IE3
Ta 40°C Ins.Cl.F S1 1000m 225kg 93.6%
NEMA Nom.Eff. 94.1%

V	Hz	min-1	kW	cosφ	A
Δ 380	50	1472	30.0	0.85	57.3
Δ 400	50	1476	30.0	0.84	55.0
Y 690	50	1476	30.0	0.84	31.8
Δ 415	50	1478	30.0	0.82	54.1
Δ 460	60	1778	30.0	0.83	48.0

Inverter supply plate

3~4P LSES200LU T 2019
N° 123456A19 001 IP55 IK08 IE3
Ta 40°C Ins.Cl.F S9 1000m 225kg

V	Hz	min-1	kW	cosφ	A
Δ 400	50	1472	30.0	0.85	59.1

Inverter settings
min.Fs (kHz) 3
Nmax (min-1) 2610

Motor performance
Hz 10 17 25 50 87
T/Tn% 80 90 100 100 57 Tn(Nm) 194

IE3 power < 7.5 kW*

Main supply plate

3~4P LSES112MU T 2019
N° 123456A19 001 IP55 IK08 T IE3
Ta 40°C Ins.Cl.F S1 1000m 37kg 88.6%
NEMA Nom.Eff. 89.5%

V	Hz	min-1	kW	cosφ	A
Y 380	50	1452	4.00	0.85	8.05
Δ 230	50	1456	4.00	0.82	13.7
Y 400	50	1456	4.00	0.82	7.90
Y 415	50	1460	4.00	0.80	7.80
Y 460	60	1764	4.00	0.79	7.05

Inverter supply plate

3~4P LSES112MU T 2019
N° 123456A19 001 IP55 IK08 T IE3
Ta 40°C Ins.Cl.F S9 1000m 37kg

V	Hz	min-1	kW	cosφ	A
Y 400	50	1452	4.00	0.85	8.45
Δ 400	87	2562	6.96	0.85	14.7

Inverter settings
min.Fs (kHz) 3

Motor performance
Hz 10 17 25 50 87
T/Tn% 90 100 100 100 57 Tn(Nm) 26.2

* Valid only for 2 & 4 pole motors except 2P 3 kW and 4P 2.2 kW.

IE2 power ≥ 7.5 kW

Main supply plate

3~4P LSES160LU T 2019
N° 123456A19 001 IP55 IK08 IE2
Ta 40°C Ins.Cl.F S1 1000m 90kg 90.6%

V	Hz	min-1	kW	cosφ	A
Δ 380	50	1460	15.0	0.86	29.1
Δ 400	50	1464	15.0	0.84	28.3
Δ 415	50	1468	15.0	0.82	28.0
Δ 460	60	1772	15.0	0.83	24.5

Must be used with inverter in EU

Inverter supply plate

3~4P LSES160LU T 2019
N° 123456A19 001 IP55 IK08 IE2
Ta 40°C Ins.Cl.F S9 1000m 90kg

V	Hz	min-1	kW	cosφ	A
Δ 400	50	1460	15.0	0.87	30.3

Inverter settings
min.Fs (kHz) 3
Nmax (min-1) 2610

Motor performance
Hz 10 17 25 50 87
T/Tn% 75 90 100 100 57 Tn(Nm) 97.8

IE2 power < 7.5 kW

Main supply plate

3~4P LSES112MU T 2019
N° 123456A19 001 IP55 IK08 T IE2
Ta 40°C Ins.Cl.F S1 1000m 35kg 86.6%

V	Hz	min-1	kW	cosφ	A
Y 380	50	1435	4.00	0.86	8.15
Δ 230	50	1445	4.00	0.84	13.6
Y 400	50	1445	4.00	0.84	7.85
Y 415	50	1450	4.00	0.83	7.65
Y 460	60	1756	4.00	0.83	6.75

Must be used with inverter in EU

Inverter supply plate

3~4P LSES112MU T 2019
N° 123456A19 001 IP55 IK08 T IE2
Ta 40°C Ins.Cl.F S9 1000m 35kg

V	Hz	min-1	kW	cosφ	A
Y 400	50	1435	4.00	0.86	8.50
Δ 400	87	2545	6.96	0.86	14.8

Inverter settings
min.Fs (kHz) 3

Motor performance
Hz 10 17 25 50 87
T/Tn% 85 100 100 100 57 Tn(Nm) 26.4

Plate values provided for information only.

IMfinity® 3-phase induction motors - IE2 - IE3 - IE4 - Non IE Efficiency

General

Electrical and mechanical data

Identification

INFORMATION PLATES FLSES CAST IRON MOTORS

IE2

Main supply plate

Nidec LEROY-SOMER		MOT. 3~ FLSES 315 LB		CE	
N° 62349200XM01		2014	1220 kg		
DE 6320 C3	50 g	12400h	IP 55	1000 m	
NDE 6316 C3	33 g	12400h	IK 08	IM 1001	
40 °C		Ins. cl. F	S1	100%	6 d/h SF 1.0
V		Hz	min ⁻¹	kW	A
Δ 400	50	1486	200	357	0.85
Δ 690	50	1486	200	206	0.85
Δ 380	50	1483	200	367	0.87
Δ 415	50	1487	200	348	0.84
Δ 460	60	1785	200	308	0.85
		cos φ		%	
				95.1	
Must be used with inverter in EU Polyrex EM 103					
IEC 60034-1 - MADE IN FRANCE					

IE3

Main supply plate

Nidec LEROY-SOMER		MOT. 3~ FLSES 315 LB		CE	
N° 62349200XM01		2014	1220 kg		
DE 6320 C3	50 g	12400h	IP 55	1000 m	
NDE 6316 C3	33 g	12400h	IK 08	IM 1001	
40 °C		Ins. cl. F	S1	100%	6 d/h SF 1.0
V		Hz	min ⁻¹	kW	A
Δ 400	50	1486	200	354	0.85
Δ 690	50	1486	200	204	0.85
Δ 380	50	1483	200	364	0.87
Δ 415	50	1487	200	345	0.84
Δ 460	60	1785	200	307	0.85
		cos φ		%	
				96.0	
Polyrex EM 103					
IEC 60034-1 - MADE IN FRANCE					

IE4

Main supply plate

Nidec LEROY-SOMER		MOT. 3~ FLSES 355 LB 4		CE	
N° 61138201DF01		2015	1650 kg		
DE 6322 C3	60 g	8316 h	IP 55	1000 m	
NDE 6316 C3	33 g	8316 h	IK 08	IM 1001	
40 °C		Ins. cl. F	S1	100%	6 d/h SF 1.0
V		Hz	min ⁻¹	kW	A
Δ 400	50	1490	250	439	0.85
Δ 690	50	1490	250	253	0.85
Δ 380	50	1488	250	454	0.87
Δ 415	50	1491	250	428	0.84
Δ 460	60	1791	250	381	0.85
		cos φ		%	
				96.7	
Polyrex EM 103					
IEC 60034-1 - MADE IN FRANCE					

Inverter supply plate (for IE2-IE3-IE4)

Nidec LEROY-SOMER		MOT. 3~ FLSES 315 LB		CE	
N° 62349200XM01		2014	1220 kg		
DE 6320 C3	50 g	12400h	IP 55	1000 m	
NDE 6316 C3	33 g	12400h	IK 08	IM 1001	
40 °C		Ins. cl. F	S9	100%	6 d/h SF
V		Hz	min ⁻¹	kW	A
Δ 400	50	1486	200	357	0.85
Inverter settings					
		min. F _{sw} (kHz): 3		N _{max} (min ⁻¹): 2610	
Motor performance					
Hz	10	17	25	50	60
T/Tn%	85	93	100	100	82.3
Polyrex EM 103					
IEC 60034-1 - MADE IN FRANCE					

INFORMATION PLATES PLSES DRIP-PROOF MOTORS

IE3

Main supply plate

Nidec LEROY-SOMER		3~ 4P PLSES315LUS T 2019		CE	
N° 123456A19 001		IP23	IK08		
Ta 40°C		Ins. Cl. F	S1	1000m	960kg
DE: 6320 C3	POLYREX EM 103				
NDE: 6316 C3	48g / 7800h				
V	Hz	min ⁻¹	kW	cos φ	A
Δ 380	50	1484	250	0.85	465
Δ 400	50	1486	250	0.83	452
Y 690	50	1486	250	0.83	261
Δ 415	50	1488	250	0.81	446
Δ 460	60	1790	250	0.82	397
IEC 60034-1					
E8854M					
H50P_500C					

Inverter supply plate

Nidec LEROY-SOMER		3~ 4P PLSES315LUS T 2019		CE	
N° 123456A19 001		IP23	IK08		
Ta 40°C		Ins. Cl. F	S9	1000m	960kg
DE: 6320 C3	POLYREX EM 103				
NDE: 6316 C3	48g / 10200h				
V	Hz	min ⁻¹	kW	cos φ	A
Δ 400	50	1484	250	0.85	478
Inverter settings					
		min. F _{sw} (kHz): 3		N _{max} (min ⁻¹): 2610	
Motor performance					
Hz	10	17	25	50	87
T/Tn%	70	90	90	100	57
Tn (Nm): 1610					
IEC 60034-1					
E8854M					
H50P_600B					

Electro_Motor.ir

Plate values provided for information only.

INFORMATION PLATES LS ALUMINIUM MOTORS

Nidec
LEROY-SOMER
IP 55 IK 00 Ins.Cl.F 40°C amb S1

~3 LS71M/T_
N°502131/001/2015

7,5 kg

V	Hz	min-1	kW	cos φ	A
Δ 230	50	1420	0,37	0,7	1,9
Y 380/400	50	1410	0,37	0,7	1,1
T 415	50	1430	0,37	0,65	1,1
Y 440/460	60	1710	0,44	0,7	1,1

IEC60034-1

Frame size 56 to 71

Nidec
LEROY-SOMER
Ta 40°C Ins.Cl.F S1 1000m 23kg

3~4P LS112M
N° 123456A19 001
2019 IP55 IK08 T

CE

DE: 6206 ZZ C3
NDE: 6205 ZZ C3

V	Hz	min-1	kW	cos φ	A
Y 380	50	1420	4,00	0,84	8,90
Δ 230	50	1430	4,00	0,79	15,5
Y 400	50	1430	4,00	0,79	8,95
Y 415	50	1440	4,00	0,75	9,10
Y 460	60	1735	4,60	0,80	8,70

IEC60034-1

Frame size 80 to 160 M

Nidec
LEROY-SOMER
Ta 40°C Ins.Cl.F S1 1000m 166kg

3~4P LS200LR T 2019
N° 123456A19 001 IP55 IK08

CE

DE: 6312 ZZ C3
NDE: 6312 ZZ C3

V	Hz	min-1	kW	cos φ	A
Δ 380	50	1458	30,0	0,85	58,4
Δ 400	50	1464	30,0	0,83	57,4
Y 690	50	1464	30,0	0,83	33,2
Δ 415	50	1468	30,0	0,81	56,6
Δ 460	60	1764	34,0	0,85	54,2

IEC60034-1

Frame size 160 L to 225

Electro_Motor.ir

Plate values provided for information only.



IP 55
Cl. F - ΔT 80 K

The complete motor **reference** described below will enable you to order the desired **equipment**.

The selection method consists of following the terms in the designation.

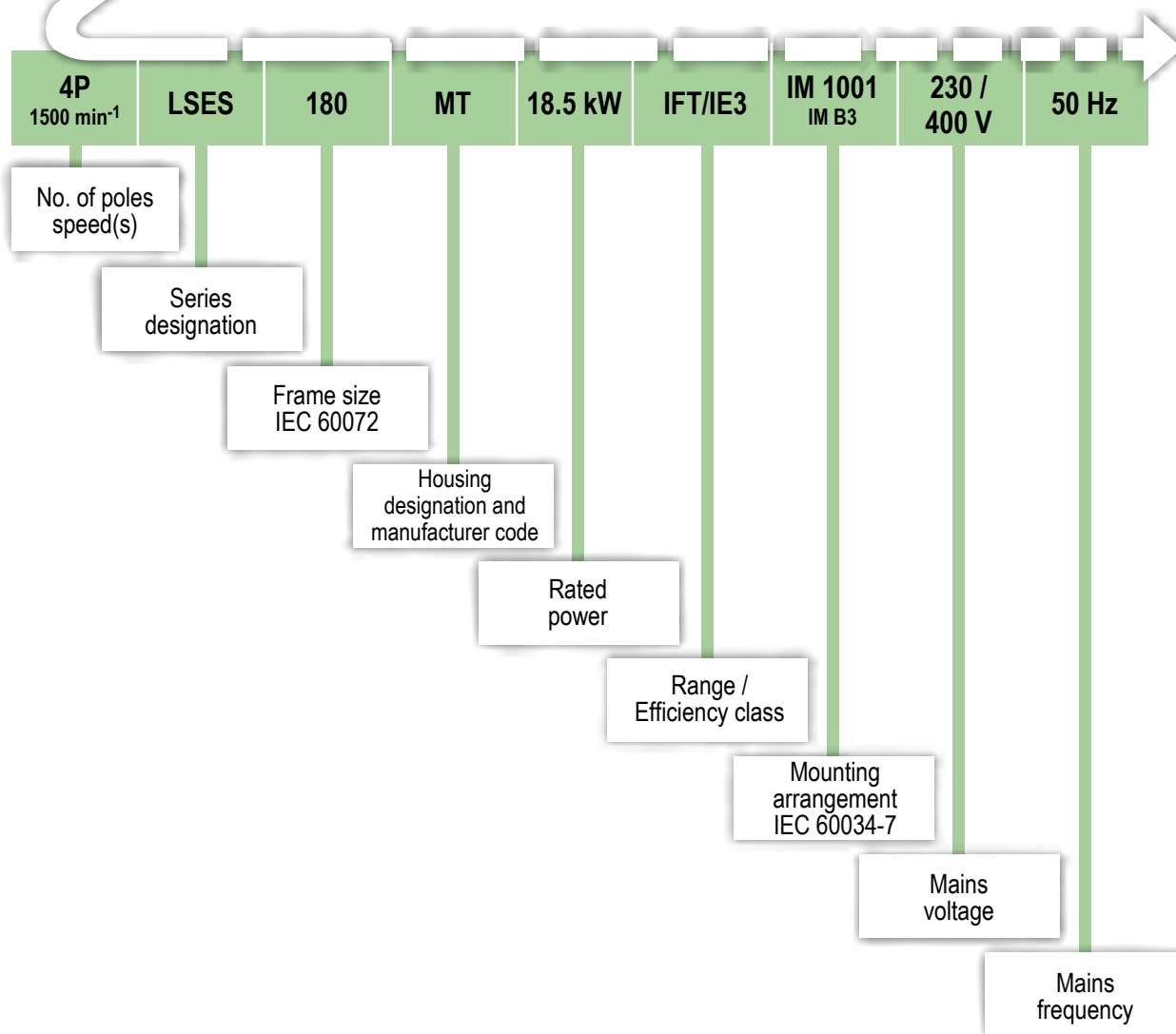

Electro_Motor.ir

IMfinity® 3-phase induction motors - IE2 - IE3 - IE4 - Non IE Efficiency

IP55 Aluminium frame

General information

Description

Component	Materials	Remarks
Housing with cooling fins	Aluminium alloy	<ul style="list-style-type: none"> - with integral or screw-on feet, or without feet - 4 or 6 fixing holes for housings with feet - lifting rings for frame size ≥ 100 - earth terminal with an optional jumper screw
Stator	Insulated low-carbon magnetic steel laminations Electroplated copper	<ul style="list-style-type: none"> - low carbon content guarantees long-term lamination pack stability - semi-enclosed slots - class F insulation
Rotor	Insulated low-carbon magnetic steel laminations	<ul style="list-style-type: none"> - inclined cage bars - rotor cage pressure die-cast in aluminium (or alloy for special applications) - shrink-fitted to shaft - rotor balanced dynamically, 1/2 key
Shaft	Steel	<ul style="list-style-type: none"> - for frame size ≤ 160 MP - LR: <ul style="list-style-type: none"> • tapped hole • closed keyway - for frame size ≥ 160 M - L: <ul style="list-style-type: none"> • tapped hole • open keyway
End shields	Aluminium alloy	<ul style="list-style-type: none"> - 56 - 63 - 71 front and rear - 80 - 90 NDE shield
	Cast iron	<ul style="list-style-type: none"> - 80 - 90 DE shield and optional for 80 and 90 NDE shield - 100 to 315 DE shield and NDE shield
Bearings and lubrication		<ul style="list-style-type: none"> - permanently greased bearings frame size 56 to 225 - regreasable bearings frame size 250 to 315 - bearings preloaded at non drive end
Labyrinth seal Lipseals	Plastic or steel Synthetic rubber	<ul style="list-style-type: none"> - lipseal or deflector at drive end for all flange mounted motors - lipseal, deflector or labyrinth seal for foot mounted motors
Fan	Composite material or aluminium alloy	- 2 directions of rotation: straight blades
Fan cover	Composite material or pressed steel	- fitted, on request, with a drip cover for operation in vertical position, shaft end facing down (steel cover)
Terminal box	Composite material or aluminium alloy	<ul style="list-style-type: none"> - IP 55 - can be turned at 90° - fitted with a terminal block with 6 steel terminals as standard (brass as an option) - terminal box fitted with threaded plugs, supplied without cable glands (cable glands as an option) - 1 earth terminal in each terminal box - fixing system consisting of a cover with captive screws

In the standard version. the motors are wound 400 V / 50 Hz:

- power ratings ≤ 5.5 kW: Y connection; 230 / 400 V

- power ratings ≥ 7.5 kW: connection D; 400 / 690 V

IMfinity® 3-phase induction motors - IE2 - IE3 - IE4 - Non IE Efficiency

IP55 Aluminium frame

Electrical and mechanical characteristics

Non IE efficiency - Powered by the mains

IP55 ALUMINIUM MOTORS

Type	Rated power P _n kW	Rated torque M _n N.m	Starting torque/ Rated torque M _d /M _n	Maximum torque/ Rated torque M _m /M _n	Starting current/Rated current I _d /I _n	Moment of inertia J kg.m ²	Weight IM B3 kg	Noise LP db(A)	400V / 50Hz							
									Rated speed N _n min ⁻¹	Rated current I _n A	Efficiency IEC 60034-2-1 2014			Power factor		
											η 4/4	η 3/4	η 2/4	cos φ 4/4	cos φ 3/4	cos φ 2/4
2 poles																
LS 56M*	0.09	0.31	5.3	5.4	5	0.00015	3.8	54	2860	0.44	54.00	45.20	37.10	0.55	0.45	0.40
LS 56M*	0.12	0.41	4	4.1	4.6	0.00015	3.8	54	2820	0.5	58.70	54.00	45.20	0.60	0.55	0.45
LS 63M*	0.18	0.62	3.3	2.9	5	0.00019	4.8	57	2790	0.52	67.40	66.90	59.30	0.75	0.65	0.55
LS 63M*	0.25	0.85	2.9	3.2	5.4	0.00025	6.0	57	2800	0.71	67.80	67.30	59.20	0.75	0.65	0.55
LS 71M*	0.37	1.26	3.3	3.9	5.2	0.00035	6.4	62	2800	0.98	68.40	67.60	63.90	0.80	0.70	0.60
LS 71L*	0.55	1.88	3.2	3.1	6	0.00045	7.3	62	2800	1.32	75.70	75.20	71.10	0.80	0.70	0.55
LS 71L*	0.75	2.58	3.3	2.9	6	0.00060	8.3	62	2780	1.7	73.00	73.00	71.00	0.85	0.75	0.65
LS 80L	0.75	2.55	2.15	2.4	5.05	0.00070	8.4	56	2820	1.75	72.10	73.40	71.50	0.85	0.77	0.64
LS 80L	1.1	3.70	2.35	2.6	5.3	0.00090	9.7	56	2830	2.5	75.00	76.33	74.90	0.84	0.77	0.63
LS 90SL	1.5	4.95	2.5	3	6.1	0.0014	13.5	66	2880	3.35	77.20	77.80	76.30	0.84	0.77	0.66
LS 90L	2.2	7.30	2.75	2.9	6.17	0.0021	15.7	67	2870	4.6	79.70	81.10	80.60	0.86	0.80	0.69
LS 100L	3	10	2.85	2.9	6	0.0022	19.5	70	2860	6.45	81.50	82.70	81.50	0.82	0.75	0.62
LS 100L	3.7	12.2	3.65	3.9	8.05	0.0029	24.8	66	2905	7.8	82.70	83.20	82.00	0.83	0.76	0.65
LS 112M	4	13.2	3.55	3.55	7.9	0.0029	24.8	66	2890	8.2	83.10	84.00	83.30	0.85	0.79	0.68
LS 132S	5.5	18	2.3	3.15	7.35	0.0079	35.8	63	2925	11	84.70	85.00	83.30	0.85	0.79	0.67
LS 132S	7.5	24.4	2.65	3.5	8.33	0.0096	39.4	63	2915	14.6	86.00	86.60	85.50	0.86	0.79	0.67
LS 132M	9	29.3	2.15	2.95	6.55	0.011	50.7	71	2935	18	86.80	87.40	86.60	0.83	0.77	0.66
LS 160MP	11	35.8	2.2	3.05	6.77	0.0126	61.2	74	2935	22	89.20	89.40	88.20	0.81	0.74	0.63
LS 160MR	15	48.8	2.65	3.25	7.81	0.015	72.9	75	2935	27.9	90.10	90.70	90.10	0.86	0.82	0.73
LS 160L	18.5	60	2.7	3.36	7.54	0.044	100	72	2945	34.3	91.80	92.50	92.20	0.85	0.81	0.71
LS 180MT	22	71.5	2.65	3.2	7.3	0.052	105	73	2940	41.6	89.90	90.60	90.30	0.85	0.81	0.72
LS 200LR	30	97.1	3.05	3.55	8.25	0.0901	158	74	2950	55.8	90.70	91.10	90.80	0.86	0.82	0.74
LS 200L	37	120	1.95	2.75	6.45	0.117	198	74	2940	67.9	91.20	91.80	91.80	0.86	0.83	0.76
LS 225MT	45	146	2.25	3.3	7.15	0.1389	200	73	2950	83.3	91.70	92.30	92.30	0.85	0.81	0.73
4 poles																
LS 56M*	0.09	0.61	2.75	2.75	3.2	0.00025	4	47	1400	0.39	53.00	47.60	40.80	0.60	0.52	0.42
LS 63M*	0.12	0.83	2.41	2.31	3.2	0.00035	4.8	49	1380	0.44	54.00	52.00	44.80	0.70	0.58	0.47
LS 63M*	0.18	1.24	2.61	2.61	3.7	0.00048	5	49	1390	0.64	60.00	56.00	49.00	0.65	0.55	0.44
LS 71M*	0.25	1.68	2.73	2.93	4.63	0.00068	6.4	49	1425	0.8	67.00	65.00	58.00	0.65	0.55	0.44
LS 71M*	0.37	2.49	2.41	2.81	4.9	0.00085	7.3	49	1420	1.06	70.00	70.00	64.00	0.70	0.59	0.47
LS 71L*	0.55	3.75	2.32	2.53	4.8	0.0011	8.3	49	1400	1.62	68.00	68.00	63.00	0.70	0.62	0.49
LS 80L	0.55	3.75	2.15	2.3	3.9	0.00128	8.2	61	1405	1.7	66.90	64.60	57.30	0.71	0.59	0.46
LS 80L	0.75	5.1	1.8	2.15	4.25	0.00164	9.2	61	1400	2.05	69.30	68.80	64.00	0.77	0.67	0.53
LS 80L	0.9	6.05	3.1	3.1	5.33	0.0024	11.8	61	1420	2.55	74.30	73.70	69.60	0.69	0.58	0.45
LS 90SL	1.1	7.35	1.5	2.15	4.5	0.00265	12	48	1425	2.5	76.10	78.40	77.60	0.84	0.77	0.64
LS 90L	1.5	10	1.9	2.4	5.25	0.00337	13.8	49	1430	3.3	79.30	80.80	79.80	0.83	0.75	0.62
LS 90L	1.8	12	2	2.55	5.6	0.0038	14.8	54	1435	3.95	79.90	81.30	80.00	0.82	0.74	0.60
LS 100L	2.2	14.6	2.3	2.7	5.7	0.0043	18.8	52	1435	4.8	80.20	81.60	80.40	0.82	0.74	0.61
LS 100L	3	20	2.6	3.1	6.65	0.0057	22.5	50	1435	6.35	82.20	83.70	83.00	0.83	0.76	0.64
LS 112M	4	26.7	2.65	3.05	5.85	0.0062	22.8	51	1430	8.95	81.40	82.40	80.60	0.79	0.70	0.55
LS 132S	5.5	36.1	2.41	3.06	6.33	0.0145	38.3	58	1456	11.5	86.40	87.70	87.60	0.81	0.74	0.60
LS 132M	7.5	49.6	2.29	2.99	5.9	0.0192	47.9	63	1445	15.6	86.40	87.70	87.60	0.80	0.74	0.60
LS 132M	9	59.5	2.4	2.95	6.64	0.0228	51.8	63	1445	17.7	88.10	89.60	89.90	0.83	0.77	0.65
LS 160MP	11	72.3	2.9	3.3	6.85	0.0278	66	63	1450	22.1	88.80	89.70	89.30	0.81	0.72	0.58
LS 160LR	15	98.4	2.85	3.35	7.45	0.0357	79	64	1456	30	89.10	89.90	89.40	0.81	0.73	0.59
LS 180MT	18.5	121	2.1	3.15	7.95	0.0844	100	58	1464	36	89.30	90.10	90.10	0.83	0.77	0.66
LS 180LR	22	143	2.6	3.35	8.35	0.0956	108	60	1466	41.9	89.90	90.70	90.60	0.84	0.79	0.68
LS 200LR	30	196	1.95	2.55	7.6	0.1563	166	64	1464	57.4	90.70	91.60	91.70	0.83	0.78	0.69
LS 225ST	37	240	2.65	2.7	6.14	0.2294	205	64	1474	71	91.90	92.60	92.70	0.82	0.77	0.67
LS 225MR	45	292	2.25	2.35	6.72	0.2885	230	70	1472	85.7	92.30	93.00	92.90	0.82	0.78	0.68
6 poles																
LS 63M*	0.09	1.02	1.59	1.59	2.11	0.0006	5.5	48	860	0.46	33.00	30.00	24.00	0.80	0.70	0.63
LS 71M*	0.12	1.25	2.6	2.62	3	0.0007	6.5	52	950	0.75	44.00	38.00	30.00	0.51	0.44	0.38
LS 71M*	0.18	1.92	1.78	1.88	3.26	0.0011	7.6	52	945	0.95	51.00	47.00	39.00	0.52	0.46	0.38
LS 71L*	0.25	2.84	1.56	1.56	3.04	0.0013	7.9	52	915	1.15	50.00	48.00	40.00	0.60	0.52	0.43
LS 80L	0.37	3.7	2.1	2.45	3.85	0.0032	8.8	41	954	1.30	61.70	58.50	50.30	0.66	0.55	0.44
LS 80L	0.55	5.5	2.55	2.95	3.4	0.0042	10.6	41	956	2.15	61.00	56.80	47.40	0.60	0.50	0.40
LS 90SL	0.75	7.5	1.9	2.4	3.7	0.0033	14.8	43	952	2.25	70.00	70.20	66.80	0.68	0.58	0.44
LS 90L	1.1	11.2	1.85	2.2	3.85	0.0038	16	56	940	3.05	72.90	74.00	72.20	0.71	0.61	0.47
LS 100L	1.5	15.2	1.98	2.28	3.75	0.00437	20.3	70	940	4.00	75.20	77.10	76.00	0.72	0.62	0.48
LS 112MG	2.2	21.9	2.05	2.4	4.75	0.0152	30.4	50	960	5.60	77.70	78.90	78.00	0.73	0.65	0.52
LS 132S	3	29.8	2.35	2.65	5	0.0192	38.4	49	960	7.65	79.70	80.71	79.80	0.71	0.63	0.50
LS 132M	4	39.6	2.15	2.6	5.35	0.02528	47.8	53	964	9.25	81.40	82.80	82.60	0.77	0.71	0.59
LS 132M	5.5	54.4	2.55	2.75	5.6	0.03027	54	58	966	13.10	83.10	84.20	83.60	0.73	0.66	0.53
LS 160M	7.5	73.5	1.7	2.7	5.2	0.0884	82	59	974	17.20	84.70	84.85	83.30	0.74	0.66	0.53
LS 160L	11	109	1.85	2.55	5.23	0.116	90	59	968	23.70	86.40	87.30	86.80	0.78	0.72	0.59
LS 180LR	15	149	1.8	2.5	4.75	0.139	108	59	960	31.90	87.00	88.20	87.80	0.78	0.73	0.61
LS 200LR	18.5	181	2.6	2.85	6.65	0.25	165	58	974	37.70	88.60	89.60	89.70	0.80	0.75	0.64

* non IMfinity® generation

IMfinity® 3-phase induction motors - IE2 - IE3 - IE4 - Non IE Efficiency

IP55 Aluminium frame

Electrical and mechanical characteristics

Non IE efficiency - Powered by the mains

Type	Rated power at 50Hz P _n kW	380V / 50Hz				415V / 50Hz				460V / 60Hz				
		Rated speed N _n min ⁻¹	Rated current I _n A	Efficiency η 4/4	Power factor Cos φ 4/4	Rated speed N _n min ⁻¹	Rated current I _n A	Efficiency η 4/4	Power factor Cos φ 4/4	Rated power at 60Hz P _n kW	Rated speed N _n min ⁻¹	Rated current I _n A	Efficiency η 4/4	Power factor Cos φ 4/4
2 poles														
LS 56M*	0.09	2850	0.42	56.00	0.60	2870	0.49	51.00	0.50	0.11	3454	0.44	59.60	0.54
LS 56M*	0.12	2800	0.47	60.70	0.65	2830	0.50	56.70	0.60	0.14	3404	0.46	61.40	0.66
LS 63M*	0.18	2750	0.52	65.40	0.80	2800	0.55	65.40	0.70	0.22	3398	0.49	73.00	0.76
LS 63M*	0.25	2750	0.73	64.80	0.80	2810	0.74	66.80	0.70	0.30	3418	0.64	78.20	0.76
LS 71M*	0.37	2780	0.97	68.40	0.85	2820	0.95	68.40	0.80	0.44	3382	0.94	70.30	0.86
LS 71L*	0.55	2750	1.33	74.70	0.85	2810	1.36	75.70	0.75	0.66	3379	1.31	77.40	0.82
LS 71L*	0.75	2730	1.84	71.00	0.85	2790	1.74	73.00	0.80	0.90	3359	1.7	76.76	0.87
LS 80L	0.75	2790	1.85	70.60	0.88	2840	1.75	72.60	0.82	0.86	3425	1.7	74.70	0.84
LS 80L	1.1	2800	2.6	74.10	0.87	2845	2.5	75.40	0.81	1.26	3435	2.45	77.30	0.84
LS 90SL	1.5	2860	3.45	76.40	0.86	2890	3.35	77.50	0.81	1.72	3475	3.25	78.00	0.85
LS 90L	2.2	2840	4.85	79.70	0.86	2890	4.6	80.10	0.83	2.53	3465	4.55	80.70	0.86
LS 100L	3	2835	6.6	80.70	0.86	2870	6.45	81.40	0.79	3.45	3455	6.25	82.80	0.84
LS 100L	3.7	2890	7.9	82.50	0.86	2910	7.75	82.80	0.80	4.26	3505	7.55	83.60	0.85
LS 112M	4	2875	8.35	82.50	0.85	2900	8.15	83.30	0.82	4.6	3485	7.95	84.00	0.86
LS 132S	5.5	2910	11.1	84.40	0.89	2930	11	84.60	0.82	6.3	3520	10.6	85.20	0.88
LS 132S	7.5	2900	15	85.50	0.89	2925	15.2	85.60	0.80	8.6	3510	14.1	86.60	0.89
LS 132M	9	2925	18.4	86.40	0.86	2940	18.3	86.73	0.79	10.3	3535	17.7	87.30	0.84
LS 160MP	11	2930	21.9	89.10	0.86	2945	22.3	88.90	0.77	12.6	3540	21.1	89.70	0.84
LS 160MR	15	2925	28.6	89.50	0.89	2945	27.5	90.30	0.84	17.2	3540	27.2	90.40	0.88
LS 160L	18.5	2935	35.6	91.20	0.87	2954	34.1	92.00	0.82	21	3545	34.4	89.20	0.87
LS 180MT	22	2930	42.6	89.30	0.88	2945	41	90.20	0.83	25	3545	39.7	90.60	0.87
LS 200LR	30	2945	57.6	90.20	0.88	2954	54.5	90.90	0.84	34	3550	54.2	90.10	0.87
LS 200L	37	2925	70.8	90.30	0.87	2945	67	91.20	0.84	42	3540	66.6	90.90	0.87
LS 225MT	45	2935	86.4	91.20	0.87	2950	81.8	91.80	0.83	52	3545	82.6	92.10	0.86
4 poles														
LS 56M*	0.09	1380	0.38	54.00	0.65	1410	0.4	50.00	0.60	0.11	1702	0.38	61.60	0.58
LS 63M*	0.12	1365	0.47	54.00	0.70	1390	0.46	54.00	0.65	0.14	1678	0.45	58.79	0.69
LS 63M*	0.18	1375	0.68	60.00	0.65	1400	0.68	59.00	0.60	0.22	1689	0.64	64.86	0.65
LS 71M*	0.25	1425	0.78	68.00	0.70	1430	0.84	67.00	0.60	0.30	1684	0.82	68.42	0.77
LS 71M*	0.37	1410	1.1	71.00	0.70	1430	1.1	70.00	0.65	0.44	1713	1.05	73.00	0.73
LS 71L*	0.55	1385	1.59	68.00	0.75	1410	1.56	68.00	0.70	0.66	1671	1.56	70.60	0.75
LS 80L	0.55	1390	1.65	67.50	0.75	1415	1.75	65.50	0.67	0.63	1710	1.6	71.60	0.70
LS 80L	0.75	1380	2.05	68.30	0.81	1410	2.05	69.00	0.73	0.86	1710	1.95	73.30	0.76
LS 80L	0.9	1405	2.5	74.30	0.74	1430	2.65	73.60	0.64	1.04	1720	2.4	76.70	0.70
LS 90SL	1.1	1410	2.6	74.30	0.87	1435	2.45	76.90	0.82	1.26	1730	2.4	78.80	0.84
LS 90L	1.5	1420	3.4	78.10	0.86	1440	3.25	79.60	0.80	1.72	1735	3.2	81.20	0.83
LS 90L	1.8	1425	4.1	78.80	0.85	1445	4	80.70	0.78	2.07	1735	3.9	81.80	0.82
LS 100L	2.2	1425	4.9	79.30	0.86	1445	4.9	80.60	0.78	2.53	1735	4.7	82.40	0.82
LS 100L	3	1425	6.5	81.30	0.86	1440	6.3	82.70	0.80	3.45	1735	6.15	83.80	0.84
LS 112M	4	1420	8.9	80.90	0.84	1440	9.1	81.40	0.75	4.6	1735	8.7	83.40	0.80
LS 132S	5.5	1450	11.4	85.90	0.86	1458	11.6	85.20	0.77	6.3	1756	11	86.70	0.83
LS 132M	7.5	1440	16	85.50	0.83	1450	16.5	86.70	0.73	8.6	1750	14.9	88.00	0.82
LS 132M	9	1435	18.2	87.20	0.86	1452	17.4	89.50	0.81	10.3	1745	17.1	89.40	0.85
LS 160MP	11	1440	22.1	88.00	0.86	1454	21.5	89.30	0.80	12.6	1750	20.9	90.20	0.84
LS 160LR	15	1450	31	88.70	0.83	1458	32.2	88.90	0.73	17.2	1756	29.6	90.40	0.81
LS 180MT	18.5	1460	36.9	88.80	0.86	1468	35.7	89.50	0.81	21	1762	34	92.10	0.84
LS 180LR	22	1460	43.1	89.20	0.87	1468	41.7	89.90	0.81	25	1768	39.9	92.70	0.85
LS 200LR	30	1458	58.4	91.43	0.85	1468	56.6	91.00	0.81	34	1764	54.2	92.90	0.85
LS 225ST	37	1468	73.4	91.20	0.84	1478	69.8	92.20	0.80	42	1774	68.7	92.30	0.83
LS 225MR	45	1466	89.1	91.80	0.84	1474	84.7	92.50	0.80	52	1770	83.7	92.60	0.84
6 poles														
LS 63M*	0.09	840	0.47	33.00	0.84	880	0.46	32.00	0.80	0.11	1064	0.44	45.00	0.68
LS 71M*	0.12	910	0.62	48.00	0.59	925	0.67	45.00	0.53	0.14	1151	0.70	49.87	0.51
LS 71M*	0.18	850	0.82	48.00	0.67	895	0.82	49.00	0.60	0.22	1130	0.89	59.40	0.52
LS 71L*	0.25	830	1.09	47.00	0.71	890	1.05	50.00	0.64	0.30	1112	1.08	61.00	0.57
LS 80L	0.37	945	1.25	63.10	0.70	958	1.35	60.80	0.63	0.43	1154	1.25	66.60	0.64
LS 80L	0.55	952	2.05	63.70	0.64	960	2.35	57.90	0.56	0.63	1156	2	66.90	0.59
LS 90SL	0.75	945	2.25	69.90	0.72	956	2.3	70.10	0.65	0.86	1154	2.2	72.80	0.67
LS 90L	1.1	930	3.1	71.70	0.75	945	3.05	73.00	0.68	1.26	1145	3	75.80	0.70
LS 100L	1.5	925	4.05	73.80	0.76	945	4.05	75.50	0.68	1.72	1140	3.8	78.60	0.72
LS 112MG	2.2	952	5.85	76.50	0.75	962	5.6	77.90	0.71	2.53	1160	5.5	79.50	0.73
LS 132S	3	954	7.8	78.80	0.74	964	7.65	79.90	0.68	3.45	1160	7.5	81.60	0.71
LS 132M	4	956	9.6	80.00	0.80	966	9.15	81.60	0.75	4.6	1162	9.1	82.50	0.77
LS 132M	5.5	960	13.4	82.50	0.75	970	13.5	83.40	0.68	6.3	1158	12.4	83.90	0.76
LS 160M	7.5	970	17.3	84.44	0.78	974	17.4	84.55	0.71	8.6	1174	16.6	85.90	0.76
LS 160L	11	962	24.1	85.70	0.81	972	23.3	86.60	0.76	12.6	1162	22.1	87.80	0.82
LS 180LR	15	952	32.2	85.90	0.82	966	31.1	87.30	0.77	17.2	1150	31.4	86.90	0.79
LS 200LR	18.5	968	39.3	87.80	0.82	976	36.8	89.00	0.78	21	1174	36.4	89.30	0.81

* non IMfinity® generation

IMfinity® 3-phase induction motors - IE2 - IE3 - IE4 - Non IE Efficiency

IP55 Aluminium frame

Electrical and mechanical characteristics

IE2 - Powered by the mains

IP55 ALUMINIUM MOTORS

Type	Rated power P _n kW	Rated torque M _n N.m	Starting torque/ Rated torque M _d /M _n	Maximum torque/ Rated torque M _m /M _n	Starting current/ Rated current I _d /I _n	Moment of inertia J kg.m ²	Weight IM B3 kg	Noise LP db(A)	400V / 50Hz							
									Rated speed N _n min ⁻¹	Rated current I _n A	Efficiency IEC 60034-2-1 2014			Power factor		
											η	3/4	2/4	4/4	Cos φ	3/4
2 poles																
LSES 80L	0.75	2.5	3	3.2	6.4	0.00084	9.7	56	2850	1.6	80.60	81.50	80.00	0.85	0.78	0.66
LSES 80L	1.1	3.7	2.5	3.1	6.65	0.00095	9.8	57	2850	2.3	80.70	82.00	81.00	0.85	0.77	0.64
LSES 90SL	1.5	5	2.2	2.85	6.46	0.00201	14.4	63	2865	2.95	84.30	86.00	86.10	0.87	0.82	0.71
LSES 90L	1.8	6.05	2.95	3	7.37	0.00223	14.5	63	2885	3.65	82.50	84.70	85.00	0.86	0.81	0.70
LSES 90L	2.2	7.3	2.72	2.87	6	0.00223	15.6	64	2875	4.55	85.00	86.30	85.70	0.82	0.75	0.61
LSES 100L	3	10	4.35	3.9	7.95	0.00297	21.3	67	2855	5.9	85.30	86.35	85.73	0.86	0.79	0.67
LSES 100L	3.7	12.3	3	3.2	7.1	0.00364	24.6	67	2875	7.25	86.40	87.90	88.10	0.85	0.80	0.68
LSES 112M	4	13.3	3.35	3	7.4	0.00364	24.4	66	2875	7.9	86.00	87.50	87.60	0.85	0.79	0.68
LSES 112MG	5.5	18	2.35	3.15	7.65	0.00967	30.4	72	2920	10.5	87.70	88.40	87.70	0.86	0.81	0.70
LSES 132S	5.5	18	2.35	3.15	7.65	0.00967	35.6	72	2920	10.5	87.70	88.46	87.70	0.86	0.81	0.70
LSES 132SU	7.5	24.5	2.45	3.25	7.8	0.01207	42.7	71	2920	14.3	88.30	89.20	88.80	0.86	0.81	0.70
LSES 132M	9	29.3	2.05	2.85	6.6	0.01102	55.5	67	2935	16.8	90.70	91.50	91.40	0.85	0.80	0.71
LSES 132M	11	35.8	2.35	3.05	6.9	0.01263	55.5	71	2935	21.1	90.80	91.40	91.10	0.83	0.78	0.67
LSES 160MP	11	35.8	2.35	3.05	6.9	0.01263	65	71	2935	21.1	90.80	91.40	91.10	0.83	0.78	0.67
LSES 160MR	15	48.6	2.36	3.21	7.03	0.01506	76.5	73	2945	29.3	91.20	91.50	90.60	0.81	0.74	0.62
LSES 160L	18.5	60	2.7	3	8.13	0.049	100	69	2945	32.9	92.30	93.10	93.10	0.88	0.85	0.77
LSES 180MT	22	71.6	2.55	2.6	7.44	0.0554	100	68	2935	39.2	92.00	93.00	93.30	0.88	0.85	0.78
LSES 200LR	30	97.1	3.05	3.55	8.5	0.0929	158	74	2950	54.1	93.00	93.40	93.10	0.86	0.82	0.74
LSES 200L	37	120	1.95	2.75	6.45	0.2492	198	74	2950	67.4	94.30	94.70	94.40	0.84	0.80	0.70
LSES 225MT	45	146	2.25	3.3	7.3	0.1389	200	73	2945	81.7	93.50	94.10	94.10	0.85	0.81	0.73
LSES 250MZ	55	178	2.45	3.45	8	0.1754	234	72	2945	96	94.00	94.60	94.60	0.88	0.85	0.79
LSES 280SC	75	241	2.3	3.3	7.94	0.4092	350	79	2970	128	94.10	94.30	94.00	0.90	0.88	0.82
LSES 280MC	90	289	2.5	3.6	8.35	0.476	396	80	2972	153	94.30	94.60	94.30	0.90	0.87	0.82
LSES 315SN	110	353	2.56	3.11	7.96	0.5343	452	79	2976	187	95.30	95.20	94.30	0.89	0.86	0.79
LSES 315MP	132	423	2.25	3.2	7.68	0.5784	660	79	2974	227	95.20	95.20	94.60	0.88	0.86	0.80
LSES 315MP	160	513	2.2	3.3	7.65	1.2646	705	80	2978	275	95.40	95.50	93.90	0.88	0.86	0.80
LSES 315MP	200	642	2.15	3.5	7.78	1.3841	780	80	2974	343	95.60	95.80	95.50	0.88	0.86	0.80
4 poles																
LSES 80LG	0.75	4.95	1.95	2.8	5.85	0.00265	11.6	47	1445	1.7	81.30	81.90	80.50	0.78	0.70	0.57
LSES 80LG	0.9	5.95	1.92	2.52	6.25	0.00316	12.5	47	1445	1.95	82.30	83.40	82.60	0.80	0.72	0.50
LSES 90SL	1.1	7.3	1.9	2.65	6.05	0.00336	13.9	47	1440	2.35	82.40	84.00	83.80	0.82	0.74	0.61
LSES 90L	1.5	9.95	2.25	2.85	6.25	0.00418	16.2	47	1440	3.15	83.60	85.10	84.70	0.82	0.75	0.61
LSES 90LU	1.8	11.9	2.6	2.3	6.6	0.0045	18.6	47	1440	3.8	84.00	85.50	84.90	0.81	0.73	0.60
LSES 100L	2.2	14.5	2.52	3.07	6.6	0.00567	22.5	49	1450	4.6	85.60	86.60	86.00	0.81	0.74	0.60
LSES 100LR	3	19.9	2.75	3.15	6.7	0.00677	25.8	54	1440	6.25	85.50	86.80	86.60	0.81	0.73	0.60
LSES 112MU	4	26.4	2.2	2.95	6.24	0.01312	34.9	55	1445	7.85	87.40	89.00	89.40	0.84	0.79	0.69
LSES 132SU	5.5	36.1	2.65	3.05	7.1	0.01611	42.6	55	1456	11.2	88.50	89.50	89.20	0.80	0.73	0.60
LSES 132M	7.5	49.3	2.55	3.35	7.5	0.02286	52.1	60	1452	14.4	89.40	90.50	90.50	0.84	0.78	0.66
LSES 132M	9	58.9	2.8	3.55	7.95	0.02722	59.1	63	1458	17.2	90.00	91.00	91.00	0.84	0.78	0.67
LSES 160MR	11	71.9	3.1	3.7	8.4	0.03574	78	61	1460	20.9	90.60	91.50	91.30	0.84	0.78	0.66
LSES 160L	15	97.8	2.45	3.1	8.1	0.0712	90	60	1464	28.2	91.00	91.90	91.90	0.84	0.79	0.67
LSES 180MT	18.5	121	2.1	3.15	8.15	0.0844	100	58	1464	35.2	91.40	92.30	92.20	0.83	0.77	0.66
LSES 180LR	22	143	2.6	3.35	8.51	0.0956	108	60	1466	41.2	91.80	92.50	92.50	0.84	0.79	0.68
LSES 200LR	30	195	1.96	2.56	7.58	0.1563	166	64	1470	57.6	92.80	93.40	93.20	0.81	0.75	0.63
LSES 225ST	37	240	2.65	2.7	6.26	0.2294	205	64	1474	70.1	92.90	93.70	93.70	0.82	0.77	0.67
LSES 225MR	45	292	2.25	2.35	6.79	0.2885	230	70	1472	85.1	93.40	94.05	93.97	0.83	0.78	0.68
LSES 250ME	55	354	2.3	2.7	7.23	0.7793	350	69	1484	102	94.00	94.40	94.30	0.83	0.79	0.70
LSES 280SD	75	482	2.45	3.2	8.03	0.9595	428	69	1486	140	94.40	94.70	94.30	0.82	0.78	0.69
LSES 280MD	90	579	2.6	3.45	8.25	1.0799	470	68	1484	170	94.50	94.70	94.40	0.81	0.76	0.65
LSES 315SP	110	707	3.1	2.85	7.56	2.4322	630	76	1486	201	95.00	95.00	94.30	0.84	0.78	0.69
LSES 315MP	132	847	3.05	2.75	7.16	3.223	690	76	1486	239	95.00	95.10	94.60	0.84	0.80	0.70
LSES 315MP	160	1030	2.55	2.8	7.15	3.223	740	76	1486	293	95.00	95.10	94.60	0.83	0.78	0.67
LSES 315MR	200	1290	2.95	2.9	7.34	3.2324	820	76	1486	364	95.50	95.70	95.30	0.83	0.79	0.68
6 poles																
LSES 90SL	0.75	7.5	1.85	2.35	4.1	0.00338	14.8	43	952	2.05	76.90	77.10	73.40	0.68	0.58	0.44
LSES 90L	1.1	11.2	1.85	2.3	4.3	0.00437	17.7	53	940	2.8	79.20	80.70	79.70	0.71	0.62	0.49
LSES 100L	1.5	15.2	1.95	2.4	4.3	0.00602	24.7	53	945	3.9	80.60	81.80	80.60	0.69	0.60	0.47
LSES 112MG	2.2	21.9	2.05	2.4	5	0.01523	30.4	50	960	5.3	82.00	83.20	82.20	0.73	0.65	0.52
LSES 132S	3	29.8	2.35	2.65	5.25	0.01922	38.4	49	960	7.3	83.40	84.40	83.40	0.71	0.63	0.50
LSES 132M	4	39.6	2.15	2.6	5.63	0.02528	47.8	53	964	8.75	95.90	87.40	87.20	0.77	0.70	0.58
LSES 132M	5.5	54.4	2.55	2.75	5.8	0.03027	54	53	966	12.6	86.10	87.20	86.70	0.73	0.66	0.53
LSES 160M	7.5	73.5	1.7	2.7	5.4	0.09120	82	59	974	16.6	87.90	88.10	86.44	0.74	0.66	0.53
LSES 160LUR	11	108	1.9	2.65	5.9	0.13780	105	57	974	23.7	89.30	89.80	88.90	0.75	0.68	0.56
LSES 180L	15	147	2.6	2.9	7.28	0.20480	140	62	976	29.7	90.00	90.90	90.70	0.81	0.76	0.65
LSES 200LR	18.5	181	2.6	2.85	6.83	0.25380	165	62	974	36.8	90.80	91.80	91.90	0.80	0.75	0.65
LSES 200L	22	216	1.8	2.5	6.04	0.33000	200	62	974	42.6	90.90	92.00	92.30	0.82	0.79	0.71
LSES 225MR	30	293	2.85	3.15	7.58	0.39150	222	65	978	62.9	91.80	92.20	91.60	0.75	0.70	0.59
LSES 250ME	37	358	2.21	2.36	6.06	0.92340	300	64	986	67.9	92.50	93.00	92.90	0.85	0.81	0.72
LSES 280SC	45	437	2.21	2.51	6.43	1.12790	370	64	984	81.3	92.90	93.50	93.40	0.86	0.83	0.74
LSES 280MD	55	533	2.35	2.65	6.7	1.39950	444	59	986	100	93.30	93.80	93.60	0.85	0.81	0.72
LSES 315SP	75	723	2.95	2.55	7.4	2.89370	630	71	990	148	94.00	94.10	93.33	0.78	0.73	0.61
LSES 315MP	90	868	3.05	2.65	7.66	3.41270	700	75	990	174	94.50	94.50	93.70	0.79	0.74	0.64
LSES 315MR	110	1060	2.95	2.1	7.4	3.07760	770	73	990	209	94.80	95.00	94.50	0.80	0.76	0.66
LSES 315MR	132	1270	2.7	2.15	7.1	4.63310	860	76	990	252	95.00	95.20	94.82	0.80	0.76	0.66

IMfinity® 3-phase induction motors - IE2 - IE3 - IE4 - Non IE Efficiency

IP55 Aluminium frame

Electrical and mechanical characteristics

IE2 - Powered by the mains

Type	Rated power at 50Hz P _n kW	380V / 50Hz				415V / 50Hz				460V / 60Hz				
		Rated speed N _n min ⁻¹	Rated current I _n A	Efficiency η 4/4	Power factor Cos φ 4/4	Rated speed N _n min ⁻¹	Rated current I _n A	Efficiency η 4/4	Power factor Cos φ 4/4	Rated speed N _n min ⁻¹	Rated torque at 60Hz M _n Nm	Rated current I _n A	Efficiency η 4/4	Power factor Cos φ 4/4
2 poles														
LSES 80L	0.75	2830	1.65	79.80	0.87	2865	1.55	80.70	0.83	3475	2.06	1.35	82.50	0.83
LSES 80L	1.1	2825	2.4	79.60	0.87	2865	2.3	81.00	0.82	3475	3.02	2	83.20	0.82
LSES 90SL	1.5	2840	3.1	83.10	0.88	2880	2.9	85.00	0.85	3490	4.1	2.55	86.60	0.85
LSES 90L	1.8	2820	3.8	82.20	0.88	2860	3.55	83.30	0.85	3475	4.95	3.15	85.30	0.84
LSES 90L	2.2	2855	4.65	84.20	0.85	2885	4.55	85.30	0.79	3500	6	3.95	87.30	0.80
LSES 100L	3	2830	6.15	84.60	0.88	2875	5.85	85.84	0.83	-	-	-	-	-
LSES 100L	3.7	2860	7.55	85.50	0.87	2895	7.1	87.10	0.83	3500	10.1	6.3	88.60	0.83
LSES 112M	4	2845	8.05	85.80	0.88	2885	7.75	86.60	0.83	3500	10.9	6.8	88.00	0.84
LSES 112MG	5.5	2905	10.8	87.00	0.89	2930	10.5	88.20	0.83	3535	14.86	9.1	89.10	0.85
LSES 132S	5.5	2905	10.8	87.00	0.88	2930	10.5	88.20	0.83	3535	14.86	9.1	89.10	0.85
LSES 132SU	7.5	2905	14.5	88.10	0.89	2925	14.1	88.40	0.84	3535	20.26	12.4	89.50	0.85
LSES 132M	9	2925	17.5	90.00	0.87	2945	16.6	90.90	0.83	3550	24.2	14.7	91.60	0.84
LSES 132M	11	2930	21.5	90.40	0.86	2945	21	90.80	0.83	3550	29.6	18.1	91.90	0.83
LSES 160MP	11	2930	21.5	90.40	0.86	2945	21	90.80	0.83	3550	29.6	18.1	91.90	0.83
LSES 160MR	15	2935	29.5	91.00	0.85	2950	29.7	91.10	0.77	3558	40.26	25.2	92.20	0.81
LSES 160L	18.5	2935	34.5	91.60	0.89	2950	32.3	92.60	0.86	3554	49.7	28.7	93.10	0.87
LSES 180MT	22	2925	40.7	91.30	0.90	2945	38.1	92.40	0.87	3545	59.3	33.6	93.30	0.88
LSES 200LR	30	2945	56.1	92.50	0.88	2954	53	93.20	0.84	3558	80.5	47.1	93.30	0.86
LSES 200L	37	2945	68.8	93.90	0.87	2956	66.5	94.40	0.82	3560	99.2	58.4	94.60	0.84
LSES 225MT	45	2935	84.6	93.00	0.87	2950	80.5	93.60	0.83	3558	121	70.6	94.20	0.85
LSES 250MZ	55	2940	100	93.40	0.89	2954	93.7	94.20	0.87	3560	148	83.1	94.60	0.88
LSES 280SC	75	2964	135	93.90	0.90	2974	124	94.40	0.89	3574	200	111	94.10	0.90
LSES 280MC	90	2968	161	94.10	0.90	2972	149	94.40	0.89	3574	240	134	94.60	0.89
LSES 315SN	110	2974	195	95.10	0.90	2980	182	95.30	0.88	3578	294	164	94.80	0.89
LSES 315MP	132	2974	237	95.00	0.89	2984	221	95.30	0.87	3580	352	198	95.00	0.88
LSES 315MP	160	2974	287	95.20	0.89	2978	268	95.50	0.87	3580	427	240	95.20	0.88
LSES 315MP	200	2970	358	95.40	0.89	2980	337	95.70	0.86	3580	533	298	95.70	0.88
4 poles														
LSES 80LG	0.75	1435	1.75	80.10	0.82	1450	1.7	81.20	0.76	1754	4.1	1.5	83.30	0.75
LSES 80LG	0.9	1435	2	81.60	0.83	1450	1.95	82.60	0.78	1756	4.9	1.8	82.50	0.77
LSES 90SL	1.1	1430	2.4	81.40	0.85	1445	2.3	82.80	0.80	1752	6	2.05	85.30	0.79
LSES 90L	1.5	1430	3.25	82.80	0.85	1445	3.1	84.10	0.80	1754	8.17	2.75	86.00	0.79
LSES 90LU	1.8	1435	3.9	83.50	0.84	1450	3.75	84.50	0.79	1752	9.8	3.45	84.00	0.78
LSES 100L	2.2	1440	4.7	84.90	0.84	1454	4.5	86.00	0.79	1760	11.94	4.05	87.70	0.78
LSES 100LR	3	1430	6.35	85.50	0.84	1445	6.2	86.00	0.78	1752	16.35	5.5	87.90	0.78
LSES 112MU	4	1435	8.15	86.60	0.86	1450	7.65	88.20	0.83	1756	21.75	6.75	89.60	0.83
LSES 132SU	5.5	1450	11.4	87.90	0.83	1460	11.3	88.60	0.77	1764	29.77	9.5	91.10	0.80
LSES 132M	7.5	1445	14.8	88.70	0.87	1458	14.4	89.60	0.81	1762	40.65	12.6	91.10	0.82
LSES 132M	9	1450	17.6	89.40	0.87	1460	16.9	90.40	0.82	1764	48.72	15.2	91.90	0.83
LSES 160MR	11	1452	21.6	89.90	0.86	1462	20.8	91.00	0.81	1766	59.5	18.4	91.70	0.82
LSES 160L	15	1460	29.1	90.60	0.86	1468	28	91.30	0.82	1772	80.8	24.5	92.60	0.83
LSES 180MT	18.5	1460	36	91.20	0.86	1468	34.8	91.60	0.81	1770	99.8	30.4	93.00	0.82
LSES 180LR	22	1460	41.9	91.60	0.87	1468	41.2	91.80	0.81	1772	119	35.7	93.10	0.83
LSES 200LR	30	1466	58.6	92.40	0.84	1472	57.6	92.90	0.78	1776	161	50.1	93.90	0.80
LSES 225ST	37	1468	72.2	92.70	0.84	1478	69	93.20	0.80	1782	198	60.9	94.40	0.81
LSES 225MR	45	1466	86.2	93.10	0.85	1474	78.4	93.57	0.81	1776	242	72.5	94.39	0.82
LSES 250ME	55	1482	106	93.60	0.84	1486	99.2	94.20	0.82	1786	294	88.2	95.20	0.82
LSES 280SD	75	1484	144	94.00	0.84	1486	136	94.60	0.82	1788	401	121	94.70	0.82
LSES 280MD	90	1482	175	94.30	0.83	1488	167	94.50	0.79	1788	481	149	94.90	0.80
LSES 315SP	110	1486	208	94.80	0.85	1488	196	95.10	0.82	1788	587	175	95.40	0.83
LSES 315MP	132	1486	249	94.70	0.85	1488	235	95.00	0.82	1790	704	208	95.80	0.83
LSES 315MP	160	1484	301	94.90	0.85	1488	293	94.90	0.80	1790	854	257	95.20	0.82
LSES 315MR	200	1484	376	95.10	0.85	1488	360	95.40	0.81	1790	1067	318	95.80	0.82
6 poles														
LSES 90SL	0.75	945	2.05	76.80	0.72	956	2.1	77.00	0.68	1162	6.16	1.85	80.50	0.63
LSES 90L	1.1	930	2.9	78.10	0.74	945	2.85	79.50	0.67	-	-	-	-	-
LSES 100L	1.5	930	3.95	79.80	0.72	950	3.9	80.80	0.66	-	-	-	-	-
LSES 112MG	2.2	952	5.4	81.80	0.76	962	5.3	82.20	0.70	-	-	-	-	-
LSES 132S	3	954	7.4	83.30	0.74	964	7.35	83.60	0.68	-	-	-	-	-
LSES 132M	4	956	9.1	84.60	0.79	966	8.7	86.20	0.74	1170	32.65	7.7	88.20	0.74
LSES 132M	5.5	960	13	86.00	0.75	970	13	86.40	0.68	-	-	-	-	-
LSES 160M	7.5	970	16.7	87.60	0.78	976	16.8	87.70	0.71	1178	60.8	14.6	89.50	0.72
LSES 160LUR	11	970	24.1	88.80	0.78	978	23.4	89.50	0.73	1180	89.0	20.9	90.60	0.73
LSES 180L	15	972	30.6	89.70	0.83	978	29.2	90.40	0.79	1180	121	26.1	91.40	0.79
LSES 200LR	18.5	970	61.4	91.70	0.81	982	63.2	91.70	0.72	1178	150	31.9	92.10	0.79
LSES 200L	22	968	44.3	90.90	0.83	976	41.3	91.40	0.81	1178	178	37	92.20	0.81
LSES 225MR	30	984	70.1	92.20	0.87	988	66.9	92.70	0.83	-	-	-	-	-
LSES 250ME	37	984	70.1	92.20	0.87	988	66.9	92.70	0.83	-	-	-	-	-
LSES 280SC	45	982	84.8	92.70	0.87	986	79.1	93.10	0.85	1186	362	70.4	94.40	0.85
LSES 280MD	55	984	103	93.10	0.87	988	98	93.40	0.84	1190	441	85	95.20	0.85
LSES 315SP	75	990	152	93.90	0.80	992	146	94.30	0.76	1192	601	129	95.00	0.77
LSES 315MP	90	990	179	94.30	0.81	992	170	94.40	0.78	1192	721	152	95.00	0.78
LSES 315MR	110	988	216	94.50	0.82	992	206	95.10	0.78	1192	881	183	95.60	0.79
LSES 315MR	132	990	261	94.82	0.81	990	247	95.02	0.78	-	-	-	-	-

IP55 ALUMINIUM MOTORS

IMfinity® 3-phase induction motors - IE2 - IE3 - IE4 - Non IE Efficiency

IP55 Aluminium frame

Electrical and mechanical characteristics

IE2 - Powered by the drive

IP55 ALUMINIUM MOTORS

Type	400V / 50Hz				Rated torque M _n at S1 continuous duty					400V / 87Hz Δ				Maximum mechanical speed ¹
	Rated power	Rated speed	Rated current	Power factor	10Hz	17Hz	25Hz	50Hz	87Hz	Rated power	Rated speed	Rated current	Power factor	
	P _n kW	N _n min ⁻¹	I _n A	Cos φ 4/4	N.m	N.m	N.m	N.m	N.m	P _n kW	N _n min ⁻¹	I _n A	Cos φ 4/4	
2 poles														
LSES 80 L	0.75	2850	1.65	0.85	2.25	2.5	2.5	2.5	1.4	1.3	4936	2.9	0.85	13500
LSES 80 L	1.1	2850	2.48	0.85	3.15	3.7	3.7	3.7	2.1	1.9	4936	4.3	0.85	13500
LSES 90 SL	1.5	2865	3.21	0.87	4.25	5	5	5	2.9	2.6	4962	5.6	0.87	11700
LSES 90 L	2.2	2860	4.82	0.86	6.25	7.35	7.35	7.35	4.2	3.8	4954	8.4	0.86	11700
LSES 100 L	3	2855	6.23	0.86	8.5	10	10	10	5.8	5.2	4945	10.8	0.86	9900
LSES 112 M	4	2875	8.32	0.85	11.31	13.30	13.3	13.3	7.6	7.0	4980	14.5	0.85	9900
LSES 132 S	5.5	2920	11.09	0.86	15.3	18	18	18	10.3	9.6	5058	19.3	0.86	7600
LSES 132 SU	7.5	2920	15.08	0.86	20.8	23.3	24.5	24.5	14.1	13.1	5058	26.2	0.86	7600
LSES 132 M	9	2930	17.81	0.86	24.9	27.8	29.3	29.3	16.8	15.7	5075	31	0.86	6700
LSES 132 M	11	2935	21.89	0.83	30.4	34.0	35.8	35.8	20.6	19.1	5084	38.1	0.83	6700
LSES 160 MR	15	2935	29.68	0.85	41.5	46.4	48.8	48.8	28.1	26.1	5084	51.6	0.85	6700
LSES 160 L	18.5	2945	35.61	0.88	51	57	60	60	34.5	32.2	5101	62	0.88	6000
LSES 180 MT	22	2935	40.84	0.88	58.5	65.3	68.8	71.6	39.5	36.8	5084	71.1	0.88	5670
LSES 200 LR	30	2950	57.1	0.86	82.5	87.4	97	97	97	-	-	-	-	4500
LSES 200 L	37	2940	65.5	0.86	89	100	111	120	120	-	-	-	-	4500
LSES 225 MT	45	2945	79.8	0.85	108	121	135	146	146	-	-	-	-	4320
LSES 250 MZ	55	2945	93.9	0.88	131	147	164	178	178	-	-	-	-	4320
LSES 280 SC	75	2972	135	0.90	205	217	241	241	241	-	-	-	-	4320
LSES 280 MC	90	2972	162	0.90	246	260	289	289	289	-	-	-	-	4320
LSES 315 SN	110	2968	199	0.90	301	319	354	354	354	-	-	-	-	4320
LSES 315 MP	132	2978	238	0.88	338	381	423	423	423	-	-	-	-	3600
LSES 315 MP	160	2978	291	0.88	410	462	513	513	513	-	-	-	-	3600
LSES 315 MP	200	2974	319	0.88	453	510	567	642	642	-	-	-	-	3600
4 poles														
LSES 80 LG	0.75	1445	1.75	0.78	4.5	5	5	5	2.8	1.3	2503	3.1	0.78	11700
LSES 90 SL	1.1	1440	2.48	0.82	6.6	7.3	7.3	7.3	4.2	1.9	2494	4.3	0.82	11700
LSES 90 L	1.5	1440	3.31	0.82	9.0	10	10	10	5.7	2.6	2494	5.8	0.82	11700
LSES 100 L	2.2	1440	4.77	0.83	13.1	14.6	14.6	14.6	8.4	3.8	2494	8.3	0.83	9900
LSES 100 LR	3	1440	6.52	0.81	17.9	19.9	19.9	19.9	11.4	5.2	2494	11.3	0.81	9900
LSES 112 MU	4	1445	8.51	0.84	23.8	26.4	26.4	26.4	15.2	7	2503	14.8	0.84	9900
LSES 132 SU	5.5	1454	11.48	0.80	32.5	32.5	36.1	36.1	20.8	9.6	2515	20	0.80	7600
LSES 132 M	7.5	1452	15.08	0.84	44.4	44.4	49.3	49.3	28.3	13.1	2525	26.2	0.84	7600
LSES 132M	9	1458	17.81	0.84	53	53	58.9	58.9	33.9	15.7	2518	31	0.84	7600
LSES 160 MR	11	1460	21.89	0.84	61.1	68.3	71.9	71.9	41.3	19.1	2536	38.1	0.84	6000
LSES 160 L	15	1464	29.87	0.84	83.1	92.9	97.8	97.8	56.2	26.1	2529	52	0.84	7600
LSES 180 MT	18.5	1464	36.39	0.83	97	109	121	121	70	32.2	2539	63.3	0.83	4500
LSES 180 LR	22	1466	42.42	0.84	114	129	143	143	82	38.3	2536	73.8	0.84	5670
LSES 200 LR	30	1464	55.8	0.83	156	175	184	196	106	49	2536	97	0.83	4500
LSES 225 ST	37	1472	73.6	0.82	204	228	240	240	138	64.4	2550	128	0.82	4320
LSES 225 MR	45	1472	88.8	0.83	248	277	292	292	168	78.3	2550	155	0.83	4320
LSES 250 ME	55	1484	108	0.83	301	336	354	354	203	95.7	2570	188	0.83	4050
LSES 280 SD	75	1486	146	0.83	410	458	482	482	277	-	-	-	-	3420
LSES 280 MD	90	1484	176	0.81	492	550	579	579	333	-	-	-	-	3420
LSES 315 SP	110	1488	211	0.84	565	635	706	706	406	-	-	-	-	2700
LSES 315 MP	132	1486	250	0.85	678	763	848	848	487	-	-	-	-	2700
LSES 315 MP	160	1486	305	0.83	824	927	1030	1030	592	-	-	-	-	2700
LSES 315 MR	200	1486	356	0.83	978	1101	1223	1290	703	-	-	-	-	2700
6 poles														
LSES 90 SL	0.75	952	2.05	0.68	7.50	7.50	7.50	7.50	4.31	1.3	1649	3.6	0.68	11700
LSES 90 L	1.1	940	2.8	0.71	11.20	11.20	11.20	11.20	6.44	1.9	1628	5.1	0.71	11700
LSES 100 L	1.5	945	3.9	0.69	15.20	15.20	15.20	15.20	8.74	2.6	1637	6.9	0.69	9900
LSES 112 MG	2.2	960	5.3	0.73	21.90	21.90	21.90	21.90	12.59	3.8	1663	9.7	0.73	9900
LSES 132 S	3	960	7.3	0.71	29.80	29.80	29.80	29.80	17.13	5.2	1663	13	0.71	7600
LSES 132 M	4	964	8.8	0.77	39.60	39.60	39.60	39.60	22.76	7.0	1670	16.1	0.77	6700
LSES 132 M	5.5	966	12.6	0.73	54.40	54.40	54.40	54.40	31.26	9.6	1673	21.5	0.73	6700
LSES 160 M	7.5	974	16.6	0.74	73.50	73.50	73.50	73.50	42.24	13.1	1687	29.1	0.74	6000
LSES 160 LUR	11	974	23.7	0.75	102.60	108.00	108.00	108.00	62.07	19.1	1687	41.8	0.75	4500
LSES 180 L	15	976	29.6	0.81	117.60	132.30	147.00	147.00	84.48	26.1	1690	54.3	0.81	5670
LSES 200 LR	18.5	974	36.7	0.80	144.80	162.90	181.00	181.00	104.02	32.2	1687	68.2	0.80	4500
LSES 200 LR	22	974	42.5	0.82	172.80	194.40	216.00	216.00	124.14	38.3	1687	79.6	0.82	4500
LSES 225 MR	30	978	62.6	0.75	263.70	293.00	293.00	293.00	168.39	52.2	1694	110	0.75	4320
LSES 250 ME	37	982	67.6	0.85	322.20	358.00	358.00	358.00	205.75	64.4	1701	124	0.85	4050
LSES 280 SC	45	982	84.2	0.83	393.30	437.00	437.00	437.00	251.15	-	-	-	-	3420
LSES 280 MC	55	984	103	0.83	480.60	534.00	534.00	534.00	306.90	-	-	-	-	3420
LSES 315 SP	75	990	148	0.78	614.55	650.70	723.00	723.00	415.52	-	-	-	-	2700
LSES 315 MP	90	990	172	0.80	737.80	781.20	868.00	868.00	498.85	-	-	-	-	2700
LSES 315 MR	110	990	209	0.80	901.00	954.00	1060.00	1060.00	609.20	-	-	-	-	2700
LSES 315 MR	132	990	252	0.80	1079.50	1143.00	1270.00	1270.00	724.89	-	-	-	-	2700

(1) See Vibrations section on page 42

 Values given with a voltage drop of 30 V at the drive output

IMfinity® 3-phase induction motors - IE2 - IE3 - IE4 - Non IE Efficiency

IP55 Aluminium frame

Electrical and mechanical characteristics

IE3 - Powered by the mains

Type	Rated power P _n kW	Rated torque M _n N.m	Starting torque/ Rated torque M _d /M _n	Maximum torque/ Rated torque M _m /M _n	Starting current/Rated current I _d /I _n	Moment of inertia J kg.m ²	Weight IM B3 kg	Noise LP db(A)	400V / 50Hz							
									Rated speed N _n min ⁻¹	Rated current I _n A	Efficiency IEC 60034-2-1 2014			Power factor		
											4/4	3/4	2/4	4/4	3/4	2/4
2 poles																
LSES 80L	0.75	2.5	3.45	3.45	7.75	0.00095	10.4	58	2890	1.6	82.40	82.40	80.20	0.83	0.76	0.64
LSES 80LG	1.1	3.65	2.65	3.25	7.00	0.00223	14.1	64	2885	2.2	85.60	86.90	86.70	0.85	0.80	0.69
LSES 90SL	1.5	4.95	2.95	3.25	7.45	0.00223	15.6	64	2890	3	85.30	86.30	85.50	0.84	0.78	0.67
LSES 90L	1.8	5.95	3.11	3.39	7.52	0.00292	15.6	67	2900	3.75	85.60	86.30	85.60	0.81	0.74	0.61
LSES 90LU	2.2	7.25	3.1	3.4	8	0.00292	20.4	67	2895	4.25	86.90	88.10	87.80	0.86	0.80	0.69
LSES 100L	3	10	3.53	3.43	8.35	0.00364	24.6	67	2885	5.8	87.10	88.30	88.00	0.86	0.81	0.71
LSES 100LG	3.7	12.1	2.08	3.02	7.39	0.00941	32.4	71	2930	6.7	89.30	90.20	89.90	0.89	0.85	0.77
LSES 112MG	4	13.1	2	2.9	7.1	0.00941	32.7	71	2920	7.2	89.00	90.10	90.10	0.90	0.86	0.78
LSES 112MU	5.5	18	2.3	3.05	7.55	0.01116	34.4	63	2925	10.1	89.40	90.50	90.50	0.88	0.84	0.75
LSES 132S	5.5	18	2.3	3.05	7.55	0.01116	39.2	63	2925	10.1	89.40	90.50	90.50	0.88	0.84	0.75
LSES 132SM	7.5	24.4	2.1	2.9	6.8	0.01102	55.7	67	2935	13.8	91.20	92.10	92.10	0.86	0.83	0.74
LSES 132M	9	29.2	2.15	3.25	7.65	0.01203	59.3	67	2945	16.7	91.70	92.40	92.20	0.85	0.81	0.72
LSES 132MU	11	35.7	1.9	2.9	6.95	0.0139	62.6	72	2940	19.9	91.50	92.30	92.10	0.87	0.83	0.74
LSES 160MP	11	35.7	1.9	2.9	6.95	0.0139	70.5	72	2940	19.9	91.50	92.30	92.10	0.87	0.83	0.74
LSES 160M	15	48.6	2.3	2.75	7.86	0.049	95	69	2945	26.5	91.90	92.60	92.60	0.89	0.87	0.81
LSES 160L	18.5	59.9	2.8	3.15	7.6	0.0551	100	68	2950	32.8	92.60	93.30	93.20	0.88	0.84	0.76
LSES 180MR	22	71.1	3.15	3.15	8.67	0.0628	110	69	2954	38.7	93.20	93.90	94.00	0.88	0.85	0.77
LSES 200LR	30	97.3	2.6	3.05	7.65	0.1106	170	73	2945	51.5	93.50	94.20	94.40	0.90	0.88	0.83
LSES 200L	37	120	2	3.05	7.08	0.2492	201	73	2945	63.9	93.90	94.50	94.40	0.89	0.87	0.81
LSES 225MR	45	145	2.67	3.42	7.88	0.1597	227	76	2962	79.7	94.80	95.10	94.70	0.86	0.82	0.73
LSES 250MZ	55	178	2.45	3.45	7.9	0.1754	234	72	2954	97.5	94.70	95.20	95.20	0.86	0.82	0.74
LSES 280SC	75	241	2.3	3.3	8.05	0.4092	350	79	2970	126	95.20	95.50	95.10	0.90	0.88	0.82
LSES 280MC	90	289	2.5	3.6	8.5	0.476	396	80	2972	151	95.50	95.80	95.50	0.90	0.87	0.82
LSES 315SN	110	354	2.55	3.1	8	0.5343	452	79	2968	185	95.50	95.90	95.80	0.90	0.88	0.84
LSES 315MP	132	423	2.25	3.2	7.73	0.5784	660	80	2978	226	96.00	96.00	95.40	0.88	0.86	0.81
LSES 315MP	160	513	2.2	3.3	7.7	1.2646	705	80	2978	274	95.80	95.90	94.30	0.88	0.86	0.80
LSES 315MP	200	642	2.15	3.5	7.8	1.3841	780	80	2974	342	96.00	96.20	95.90	0.88	0.86	0.80
4 poles																
LSES 80LG	0.75	4.95	2.2	2.95	6.39	0.00335	13.6	48	1450	1.6	83.60	84.30	83.00	0.81	0.73	0.59
LSES 80L	0.9	5.9	2.58	3.08	6.26	0.00381	13.7	48	1452	1.95	83.80	84.40	83.80	0.79	0.70	0.57
LSES 90SL	1.1	7.25	2.45	3.2	6.90	0.00418	16.2	45	1450	2.3	84.80	85.70	85.00	0.81	0.74	0.61
LSES 90L	1.5	9.85	2.9	3.7	7.65	0.00524	20.4	51	1452	3.2	85.60	86.20	85.10	0.79	0.70	0.57
LSES 100L	1.8	11.8	2.41	2.73	6.42	0.00561	23.7	48	1456	3.8	86.60	87.30	86.10	0.79	0.71	0.57
LSES 100LR	2.2	14.4	3.2	3.75	7.96	0.00676	25.8	47	1454	4.65	87.10	87.70	86.70	0.78	0.70	0.57
LSES 100LG	3	19.6	2.45	3.25	7.21	0.01152	29.5	55	1464	6	89.20	89.90	89.90	0.81	0.74	0.61
LSES 112MU	4	26.2	2.7	3.1	7.23	0.01312	37	54	1456	7.9	88.90	89.80	89.60	0.82	0.77	0.65
LSES 132SM	5.5	35.9	2.8	3.6	8.39	0.02286	52	59	1462	10.5	90.30	91.00	90.60	0.84	0.77	0.65
LSES 132MU	7.5	49.1	2.95	3.35	8.12	0.02965	62.6	61	1458	13.8	90.40	91.50	91.90	0.87	0.82	0.73
LSES 160MR	9	58.7	3.1	3.65	8.69	0.03574	77.8	62	1464	17	91.00	91.80	91.70	0.84	0.78	0.67
LSES 160M	11	71.7	2.25	3.05	7.36	0.0712	93	59	1466	20.2	91.40	92.40	92.60	0.86	0.82	0.73
LSES 160LUR	15	97.6	2.55	3.45	8.47	0.0954	100	58	1468	27.3	92.10	92.90	93.00	0.86	0.82	0.72
LSES 180M	18.5	120	2.95	2.85	7.75	0.1333	130	68	1468	33.9	92.80	93.60	93.50	0.85	0.81	0.72
LSES 180LUR	22	143	3.25	3.15	8.16	0.1555	155	68	1470	41.1	93.00	93.40	93.30	0.83	0.79	0.69
LSES 200LU	30	194	3	2.8	7.31	0.2704	225	63	1476	55	93.70	94.30	94.10	0.84	0.79	0.70
LSES 225SR	37	239	3.25	3.15	7.95	0.2897	236	63	1480	70.2	93.90	94.20	93.80	0.81	0.76	0.65
LSES 225MG	45	289	2.31	2.86	7.25	0.6573	318	70	1486	83.6	94.80	95.00	94.50	0.82	0.77	0.66
LSES 250ME	55	354	2.3	2.7	7.3	0.7793	350	69	1484	101	94.70	95.10	95.00	0.83	0.79	0.70
LSES 280SD	75	482	2.45	3.2	8.08	0.9595	428	69	1486	139	95.00	95.20	94.90	0.82	0.78	0.69
LSES 280MD	90	579	2.6	3.45	8.35	1.0799	470	68	1484	168	95.50	95.70	95.40	0.81	0.76	0.65
LSES 315SP	110	707	3.1	2.85	7.57	2.4322	630	76	1486	200	95.60	95.60	94.90	0.83	0.78	0.69
LSES 315MP	132	847	3.05	2.75	7.24	3.223	390	76	1488	237	95.90	96.00	95.50	0.84	0.80	0.70
LSES 315MP	160	1030	2.55	2.8	7.2	3.223	740	76	1486	291	95.80	95.70	95.20	0.83	0.78	0.67
LSES 315MR	200	1290	2.95	2.9	7.38	3.2324	820	76	1486	362	96.00	96.00	95.50	0.83	0.79	0.68
6 poles																
LSES 90SL	0.75	7.5	1.86	2.32	4.34	0.00378	15.9	56	952	1.95	79.20	80.00	79.10	0.71	0.62	0.48
LSES 90LU	1.1	11	2.35	2.7	4.85	0.00519	21.5	56	956	2.75	81.90	82.30	80.30	0.70	0.61	0.47
LSES 100LG	1.5	14.8	2.35	2.8	5.65	0.01523	30.1	43	966	3.6	83.80	84.40	82.90	0.72	0.63	0.50
LSES 112MU	2.2	21.7	2.3	2.75	5.45	0.01899	37.3	46	966	5.4	84.30	84.80	83.50	0.70	0.61	0.49
LSES 132SM	3	29.5	2.75	3.15	6.6	0.02528	48	50	972	6.8	87.50	88.00	86.90	0.73	0.65	0.53
LSES 132M	4	39.3	2.65	2.9	6.41	0.03027	53.8	56	972	9.05	87.40	88.10	87.10	0.73	0.65	0.53
LSES 132MU	5.5	54.4	2.6	2.85	6.4	0.03699	63.4	57	966	11.7	88.10	89.20	89.10	0.77	0.70	0.58
LSES 160MU	7.5	73.2	2.0	3.05	6.93	0.1295	90	58	978	16.1	89.60	89.74	88.38	0.75	0.67	0.54
LSES 180L	11	107	3.05	3.45	8.65	0.2048	130	62	982	22.6	91.10	91.30	90.30	0.77	0.70	0.57
LSES 180LUR	15	146	3.05	3.15	8.42	0.253	165	63	980	30.7	91.50	91.90	91.30	0.77	0.70	0.58
LSES 200L	18.5	180	2.2	2.85	7.07	0.33	200	61	980	36.2	92.10	92.80	92.60	0.80	0.75	0.66
LSES 200LU	22	214	2.8	3.55	7.35	0.3901	236	62	980	44.6	92.50	92.96	92.53	0.77	0.71	0.61
LSES 225MG	30	291	2.25	2.45	6.6	0.7222	284	64	986	55.3	93.30	93.70	93.30	0.84	0.80	0.70
LSES 250ME	37	358	2.35	2.8	7.07	0.9234	310	64	986	66.9	93.90	94.40	94.30	0.85	0.81	0.72
LSES 280SC	45	437	2.2	2.45	6.62	1.1279	371	64	984	80.4	93.90	94.50	94.50	0.86	0.83	0.74
LSES 280MD	55	533	2.8	3	7.66	1.3995	444	59	986	98.6	94.70	95.20	95.00	0.85	0.81	0.72
LSES 315SP	75	723	2.95	2.55	7.5	2.8937	630	71	990	146	94.90	95.00	94.20	0.78	0.73	0.61
LSES 315MP	90	868	3.05	2.65	7.8	3.4127	700	75	990	171	95.20	95.10	94.44	0.79	0.74	0.64
LSES 315MR	110	1060	2.95	2.1	7.45	3.0776	770	72	990	208	95.40	95.60	95.10	0.80	0.76	0.66
LSES 315MR	132	1270	2.7	2.15	7.16	4.6331	860	76	990	249	95.50	95.70	95.30	0.80	0.75	0.65

IP55

IMfinity® 3-phase induction motors - IE2 - IE3 - IE4 - Non IE Efficiency

IP55 Aluminium frame

Electrical and mechanical characteristics

IE3 - Powered by the mains

IP55 ALUMINIUM MOTORS

Type	Rated power at 50Hz P _n kW	380V / 50Hz				415V / 50Hz				460V / 60Hz				
		Rated speed	Rated current	Efficiency	Power factor	Rated speed	Rated current	Efficiency	Power factor	Rated speed	Rated torque at 60Hz	Rated current	Efficiency	Power factor
		N _n min ⁻¹	I _n A	η 4/4	Cos φ 4/4	N _n min ⁻¹	I _n A	η 4/4	Cos φ 4/4	N _n min ⁻¹	M _n Nm	I _n A	η 4/4	Cos φ 4/4
2 poles														
LSES 80L	0.75	2875	1.65	81.60	0.85	2900	1.55	82.30	0.81	3505	2.04	1.40	83.30	0.80
LSES 80LG	1.1	2865	2.25	84.60	0.87	2895	2.1	86.20	0.84	3505	3	1.90	87.00	0.83
LSES 90SL	1.5	2880	3.15	84.40	0.86	2900	2.9	86.10	0.83	3510	4.08	2.65	86.90	0.82
LSES 90L	1.8	2885	3.85	85.00	0.84	2910	3.75	85.70	0.78	3515	4.89	3.30	86.90	0.82
LSES 90LU	2.2	2875	4.4	85.90	0.88	2905	4.1	87.30	0.85	3505	5.99	3.70	88.20	0.85
LSES 100L	3	2870	5.95	87.10	0.88	2900	5.65	87.60	0.84	-	-	-	-	-
LSES 100LG	3.7	2915	7.05	88.60	0.90	2935	6.35	89.80	0.88	3545	9.97	5.85	90.30	0.88
LSES 112MG	4	2905	7.6	88.10	0.91	2930	6.95	89.70	0.89	3535	10.81	6.25	90.00	0.89
LSES 112MU	5.5	2910	10.4	89.20	0.90	2930	9.8	89.80	0.87	3540	14.84	8.75	90.70	0.87
LSES 132S	5.5	2910	10.4	89.20	0.90	2930	9.8	89.80	0.87	3540	14.84	8.75	90.70	0.87
LSES 132SM	7.5	2925	14.3	90.40	0.88	2945	13.4	91.50	0.85	3550	20.17	12.00	92.10	0.85
LSES 132M	9	2935	17.2	91.20	0.87	2950	16.4	91.90	0.83	3558	24.16	14.40	92.40	0.85
LSES 132MU	11	2930	20.8	91.20	0.88	2945	19.6	91.80	0.85	3552	29.57	17.40	92.20	0.86
LSES 160MP	11	2930	20.8	91.20	0.88	2945	19.6	91.80	0.85	3552	29.57	17.40	92.20	0.86
LSES 160M	15	2935	27.6	91.90	0.90	2950	25.4	92.20	0.89	3550	40.35	22.90	92.40	0.89
LSES 160L	18.5	2945	34.1	92.40	0.89	2954	32.2	92.90	0.86	3558	49.65	28.60	93.40	0.87
LSES 180MR	22	2945	40.6	92.60	0.89	2958	38.1	93.50	0.86	3564	58.9	33.80	94.00	0.87
LSES 200LR	30	2935	54.3	93.30	0.90	2954	50	93.80	0.89	3556	80.6	44.50	94.00	0.90
LSES 200L	37	2930	66.8	93.70	0.90	2950	62	94.20	0.88	3552	99.5	56.20	93.90	0.88
LSES 225MR	45	2954	82.2	94.50	0.88	2962	79.5	94.90	0.83	3566	121	69.80	95.20	0.85
LSES 250MZ	55	2945	101	94.20	0.88	2958	96	94.90	0.84	3564	147	84.20	95.30	0.86
LSES 280SC	75	2964	133	95.00	0.90	2974	123	95.50	0.89	3574	200	110.00	95.30	0.90
LSES 280MC	90	2968	159	95.30	0.90	2972	147	95.50	0.89	3574	240	133.00	95.50	0.89
LSES 315SN	110	2962	194	95.20	0.91	2970	179	95.60	0.89	3574	294	160.00	95.80	0.90
LSES 315MP	132	2974	235	95.80	0.89	2984	220	96.00	0.87	3580	352	236.00	95.90	0.89
LSES 315MP	160	2974	283	95.80	0.90	2978	264	96.20	0.88	3580	427	236.00	95.90	0.89
LSES 315MP	200	2970	356	95.80	0.89	2980	328	96.10	0.86	3580	533	297.00	96.10	0.88
4 poles														
LSES 80LG	0.75	1440	1.65	82.60	0.83	1452	1.6	83.70	0.78	1758	4.07	1.45	85.10	0.77
LSES 80LG	0.9	1445	2	83.30	0.82	1456	1.95	84.10	0.79	1760	4.88	1.75	85.70	0.76
LSES 90SL	1.1	1445	2.35	84.10	0.84	1454	2.25	85.40	0.79	1760	5.97	2.05	86.60	0.78
LSES 90LU	1.5	1445	3.25	85.30	0.82	1456	3.2	85.70	0.76	1760	8.14	2.85	87.20	0.76
LSES 100L	1.8	1445	3.9	86.00	0.82	1458	3.75	86.80	0.79	1762	9.76	3.35	88.20	0.76
LSES 100LR	2.2	1445	4.75	86.70	0.81	1456	4.6	87.30	0.76	-	-	-	-	-
LSES 100LG	3	1456	6.2	88.70	0.83	1466	6	89.20	0.78	1770	16.2	5.25	90.50	0.79
LSES 112MU	4	1452	8.05	88.60	0.85	1460	7.8	89.00	0.80	1764	21.65	7.05	90.30	0.79
LSES 132SM	5.5	1456	10.8	89.70	0.86	1466	10.3	90.60	0.82	1770	29.67	9.20	91.70	0.82
LSES 132MU	7.5	1450	14.3	90.40	0.88	1462	13.5	90.90	0.85	1766	40.55	12.10	91.80	0.85
LSES 160MR	9	1458	17.5	90.90	0.86	1466	16.7	91.30	0.84	1768	48.6	14.90	92.20	0.82
LSES 160M	11	1462	20.8	91.40	0.88	1470	19.6	91.70	0.85	1774	59.2	17.60	92.50	0.85
LSES 160LUR	15	1464	28.6	91.50	0.87	1472	26.6	92.40	0.85	1774	80.7	24.00	93.20	0.84
LSES 180M	18.5	1466	34.9	92.60	0.87	1474	32.9	93.00	0.84	1774	99.6	29.50	93.60	0.84
LSES 180LUR	22	1466	42.3	93.00	0.85	1474	40.5	93.20	0.81	1770	119	36.30	93.80	0.81
LSES 200LU	30	1472	57.3	93.60	0.85	1478	54.1	94.10	0.82	1778	161	48.00	94.50	0.83
LSES 225SR	37	1476	72.1	93.90	0.83	1482	69.4	93.90	0.79	1782	198	61.40	94.50	0.80
LSES 225MG	45	1486	87.2	94.50	0.83	1488	82.5	94.90	0.80	1788	240	73.40	95.00	0.81
LSES 250ME	55	1482	105	94.60	0.84	1486	98.4	94.90	0.82	1786	294	88.10	95.40	0.82
LSES 280SD	75	1484	143	95.00	0.84	1486	135	95.10	0.81	1788	401	120.00	95.50	0.82
LSES 280MD	90	1482	173	95.30	0.83	1488	165	95.50	0.79	1788	481	147.00	95.80	0.80
LSES 315SP	110	1486	206	95.40	0.85	1488	195	95.70	0.82	1788	587	173.00	95.90	0.83
LSES 315MP	132	1486	247	95.60	0.85	1488	233	95.90	0.82	1790	704	207.00	96.20	0.83
LSES 315MP	160	1484	299	95.80	0.85	1488	289	95.80	0.80	1790	854	255.00	96.20	0.82
LSES 315MR	200	1484	372	96.00	0.85	1488	358	96.00	0.81	1790	1067	314.00	96.30	0.84
6 poles														
LSES 90SL	0.75	945	1.95	78.90	0.75	956	1.95	79.70	0.68	-	-	-	-	-
LSES 90L	1.1	950	2.8	81.30	0.74	960	2.8	81.90	0.67	-	-	-	-	-
LSES 100L	1.5	962	3.75	82.80	0.73	970	3.65	83.70	0.68	-	-	-	-	-
LSES 112MG	2.2	960	5.45	84.30	0.73	970	5.4	84.30	0.67	-	-	-	-	-
LSES 132S	3	968	6.8	86.90	0.77	974	6.75	87.70	0.71	-	-	-	-	-
LSES 132M	4	968	9.2	86.80	0.76	974	9.05	87.70	0.70	-	-	-	-	-
LSES 132M	5.5	960	12	88.00	0.79	968	11.5	88.60	0.75	-	-	-	-	-
LSES 160M	7.5	976	16.6	89.30	0.77	980	15.9	97.70	0.73	-	-	-	-	-
LSES 160LUR	11	980	23.2	91.00	0.79	984	22.4	91.40	0.75	1182	88.9	20.1	91.70	0.75
LSES 180L	15	976	31.6	91.20	0.79	982	30.8	91.60	0.74	1184	121	27.2	92.40	0.75
LSES 200LR	18.5	976	37.4	91.70	0.82	982	35.3	92.30	0.79	-	-	-	-	-
LSES 200L	22	978	43.8	92.23	0.79	984	42.2	92.74	0.74	-	-	-	-	-
LSES 225MR	30	984	57.1	92.90	0.86	986	53.9	93.30	0.83	1186	242	49.6	93.40	0.85
LSES 250ME	37	984	69	93.60	0.87	988	65.9	94.10	0.83	1188	297	60.0	94.10	0.86
LSES 280SC	45	982	83.9	93.70	0.87	986	78.4	94.00	0.85	1186	362	71.8	94.50	0.87
LSES 280MD	55	984	102	94.30	0.87	988	96.1	94.80	0.84	1190	441	85.3	95.20	0.85
LSES 315SP	75	990	150	94.80	0.80	992	144	95.10	0.76	1192	601	131	95.20	0.79
LSES 315MP	90	990	178	94.90	0.81	992	169	95.10	0.78	1192	721	150	95.00	0.78
LSES 315MR	110	988	214	95.10	0.82	992	205	95.70	0.78	1192	881	182	95.80	0.79
LSES 315MR	132	990	260	95.40	0.81	990	247	95.50	0.78	1192	1057	219	95.80	0.79

IMfinity® 3-phase induction motors - IE2 - IE3 - IE4 - Non IE Efficiency

IP55 Aluminium frame

Electrical and mechanical characteristics

IE3 - Powered by the drive

Type	400V / 50Hz				Rated torque M _n at S1 continuous duty					400V / 87Hz Δ				Maximum mechanical speed ¹
	Rated power	Rated speed	Rated current	Power factor	10Hz	17Hz	25Hz	50Hz	87Hz	Rated power	Rated speed	Rated current	Power factor	
	P kW	N min ⁻¹	I _n A	Cos φ 4/4	N.m	N.m	N.m	N.m	N.m	P kW	N min ⁻¹	I _n A	Cos φ 4/4	
2 poles														
LSES 80 L	0.75	2890	1.7	0.83	2.3	2.5	2.5	2.5	1.4	1.3	5006	2.9	0.83	13500
LSES 80 LG	1.1	2885	2.4	0.85	3.1	3.7	3.7	3.7	2.1	1.9	4997	4.1	0.85	11700
LSES 90 SL	1.5	2890	3.2	0.85	4.2	5.0	5.0	5.0	2.8	2.6	5006	5.5	0.85	11700
LSES 90 LU	2.2	2895	4.5	0.86	6.2	7.3	7.3	7.3	4.2	3.8	5014	7.9	0.86	11700
LSES 100 L	3	2885	6.1	0.86	8.5	10	10	10	5.7	5.2	4997	10.7	0.86	9900
LSES 112 MG	4	2920	7.9	0.89	11.1	13.1	13.1	13.1	7.5	7	5058	13.8	0.89	9900
LSES 132 S	5.5	2925	10.9	0.87	15.3	18.0	18.0	18.0	10.3	9.6	5066	19	0.87	6700
LSES 132 SM	7.5	2935	14.7	0.86	20.7	23.2	24.4	24.4	14	13.1	5084	25.6	0.86	6700
LSES 132 M	9	2945	17.5	0.86	24.8	27.7	29.2	29.2	16.8	15.7	5101	30.5	0.86	6700
LSES 160 MP	11	2940	21.3	0.86	30.4	33.9	35.7	35.7	20.5	19.1	5092	37.1	0.86	6700
LSES 160 MP	15	2945	28.7	0.88	41.3	46.2	48.6	48.6	27.9	26.1	5101	49.9	0.88	6000
LSES 160 L	18.5	2950	35	0.88	50.9	56.9	59.9	59.9	34.4	32.2	5110	61	0.88	6000
LSES 180 MR	22	2950	41.7	0.88	60.5	67.6	71.2	71.2	40.9	38.3	5110	72.5	0.88	5670
LSES 200 LR	30	2945	56	0.89	83	88	97	97	-	-	-	-	-	4500
LSES 200 LR	37	2945	69.5	0.89	96	108	120	120	-	-	-	-	-	4500
LSES 225 MR	45	2950	83.3	0.89	117	131	146	146	-	-	-	-	-	4320
LSES 250 MZ	55	2945	93.9	0.89	131	147	164	178	-	-	-	-	-	4320
LSES 280 SC	75	2970	135	0.9	205	217	241	241	-	-	-	-	-	4050
LSES 280 MC	90	2972	162	0.90	246	260	289	289	-	-	-	-	-	4050
LSES 315 SN	110	2968	199	0.9	301	319	354	354	-	-	-	-	-	3600
LSES 315 MP	132	2978	239	0.88	338	381	423	423	-	-	-	-	-	3600
LSES 315 MP	160	2978	290	0.88	410	462	513	513	-	-	-	-	-	3600
LSES 315 MP	200	2974	320	0.88	453	510	567	642	-	-	-	-	-	3600
4 poles														
LSES 80 LG	0.75	1450	1.7	0.80	4.5	5	5	5	2.8	1.31	2511	3	0.8	11700
LSES 90 SL	1.1	1450	2.4	0.81	6.5	7.3	7.3	7.3	4.2	1.91	2511	4.2	0.81	11700
LSES 90 LU	1.5	1452	3.3	0.79	8.9	9.9	9.9	9.9	5.7	2.61	2515	5.8	0.79	11700
LSES 100 LR	2.2	1454	4.8	0.79	13.0	14.4	14.4	14.4	8.3	3.83	2518	8.3	0.79	9900
LSES 100 LG	3	1460	6.4	0.81	17.6	19.6	19.6	19.6	11.3	5.22	2529	11.1	0.81	9900
LSES 112 MU	4	1458	8.4	0.8	23.6	26.2	26.2	26.2	15.1	6.96	2525	14.6	0.8	9900
LSES 132 SM	5.5	1462	11	0.85	32.3	32.3	35.9	35.9	20.6	9.57	2532	19.1	0.85	6700
LSES 132 MU	7.5	1458	14.9	0.86	44.2	44.2	49.1	49.1	28.2	13.05	2525	25.9	0.86	6700
LSES 160 MR	9	1464	17.8	0.85	52.8	52.8	58.7	58.7	33.7	15.66	2536	31	0.85	6000
LSES 160 MR	11	1466	21.6	0.85	61.0	68.1	71.7	71.7	41.2	19.14	2539	37.6	0.85	6000
LSES 160 LUR	15	1468	29.2	0.85	83.0	92.7	97.6	97.6	56.1	26.1	2543	50.8	0.85	5670
LSES 180 M	18.5	1468	36.3	0.85	96	108	120	120	69	32.19	2543	63.2	0.85	5670
LSES 180 LUR	22	1470	43.6	0.83	114	129	143	143	82	38.28	2546	75.9	0.83	4500
LSES 200 LU	30	1476	59.2	0.84	165	184	194	194	111	52.2	2557	103	0.84	4500
LSES 225 SR	37	1480	73	0.81	203	227	239	239	137	64.38	2584	127	0.81	4320
LSES 225 MG	45	1484	87.9	0.83	247	276	290	290	167	78.3	2570	153	0.83	4050
LSES 250 ME	55	1484	108	0.83	301	336	354	354	203	95.7	2570	188	0.83	4050
LSES 280 SD	75	1486	146	0.83	410	458	482	482	277	-	-	-	-	3420
LSES 280 MD	90	1484	176	0.82	492	550	579	579	333	-	-	-	-	3420
LSES 315 SP	110	1488	211	0.84	565	635	706	706	406	-	-	-	-	2700
LSES 315 MP	132	1486	250	0.85	678	763	848	848	487	-	-	-	-	2700
LSES 315 MP	160	1486	305	0.83	824	927	1030	1030	592	-	-	-	-	2700
LSES 315 MR	200	1486	356	0.83	978	1101	1223	1290	741	-	-	-	-	2700
6 poles														
LSES 90 SL	0.75	950	1.9	0.72	7.6	7.6	7.6	7.6	4.3	1.3	1645	3.4	0.72	11700
LSES 90 LU	1.1	956	2.8	0.71	11	11	11	11	6.3	1.9	1656	4.7	0.71	11700
LSES 100 LG	1.5	966	3.6	0.72	14.8	14.8	14.8	14.8	8.5	2.6	1673	6.6	0.72	9900
LSES 112 MU	2.2	966	5.4	0.70	21.7	21.7	21.7	21.7	12.5	3.8	1673	9.6	0.7	9900
LSES 132 SM	3	972	6.9	0.73	29.5	29.5	29.5	29.5	17.0	5.2	1684	12	0.73	6700
LSES 132 M	4	972	9	0.73	39.3	39.3	39.3	39.3	22.6	7	1684	16.2	0.73	6700
LSES 132 MU	5.5	966	11.8	0.76	54.4	54.4	54.4	54.4	31.3	9.6	1673	21.3	0.76	6700
LSES 160 MU	7.5	978	17.6	0.76	73.2	73.2	73.2	73.2	42.1	13.1	1694	28.4	0.76	6700
LSES 180 L	11	982	22.6	0.77	102	107	107	107	61	19.1	1701	40.8	0.77	5670
LSES 180 LUR	15	980	30.6	0.77	117	131	146	146	84	26.1	1697	55.7	0.77	4500
LSES 200 L	18.5	980	36.3	0.80	144	162	180	180	103	32.2	1697	66.5	0.8	4500
LSES 200 LU	22	980	44.6	0.77	171	193	214	214	123	38.3	1697	80.6	0.77	4500
LSES 225 MG	30	986	54.9	0.84	262	291	291	291	167	52.2	1708	102	0.84	4050
LSES 250 ME	37	986	66.6	0.85	322	358	358	358	206	64.4	1708	124	0.85	4050
LSES 280 SC	45	984	81.2	0.85	393	437	437	437	251	-	-	-	-	3420
LSES 280 MD	55	986	98.7	0.85	480	533	533	533	306	-	-	-	-	3420
LSES 315 SP	75	990	147	0.78	615	651	723	723	416	-	-	-	-	2700
LSES 315 MP	90	990	171	0.80	738	781	868	868	499	-	-	-	-	2700
LSES 315 MR	110	990	208	0.80	901	954	1060	1060	609	-	-	-	-	2700
LSES 315 MR	132	990	251	0.80	1080	1143	1270	1270	730	-	-	-	-	2700

(1) See Vibrations section on page 42

Electro_Motor.ir

 Values given with a voltage drop of 30 V at the drive output

IP55 ALUMINIUM MOTORS

IMfinity® 3-phase induction motors - IE2 - IE3 - IE4 - Non IE Efficiency
 IP55 Aluminium frame
Electrical and mechanical characteristics
Mains connection

DESCRIPTIVE TABLE OF TERMINAL BOXES FOR 400 V RATED SUPPLY VOLTAGE
 (in accordance with EN 50262)

Series	Type	No. of poles	Terminal box material	Power + auxiliaries		
				Number of drill holes	Drill hole diameter	
LS / LSES	56-63-71	2; 4; 6	Plastic	1 PE ISO 16	ISO M20 x 1.5	
	80	2; 4; 6		1 + 1 knock-out		
	90	2; 4; 6				
	100	2; 4; 6				
	112	2; 4; 6				
	132*	2; 4; 6	Aluminium alloy	2	ISO M25 x 1.5	
	160* L/LU/LUR/M/MU	2; 4; 6		3	2 ISO x M40 + 1 ISO x M16	
	180 M/MR/MT/L/LR/LUR	2; 4; 6			2 ISO x M50 + 1 ISO x M16	
	200 L/LR/LU	2; 4; 6			2 ISO x M63 + 1 ISO x M16	
	225 ST/SG/SR/MT/MR/MG	2; 4; 6		2	Removable undrilled mounting plate (see details page 145)	
	250 MZ	2				
	250 ME	4; 6				
	280 SC/SD/MC/MD	2; 4; 6				
	315 SN	2				
	315 SP/MP/MR	2; 4; 6		0	Removable undrilled mounting plate (see details page 145)	

* As an option, both ISO M25 cable glands may be replaced by 1 ISO x M25 and 1 ISO x M32 (to comply with standard DIN 42925).

TERMINAL BLOCKS

Standard motors are fitted with a block of 6 terminals complying with standard NFC 51 120, with the terminal markings complying with IEC 60034-8 (or NF EN 60034-8).

When the motor is running in U1, V1, W1 or 1U, 1V, 1W from a direct mains supply L1, L2, L3, it turns clockwise when seen from the drive shaft end.

If any two of the phases are changed over, the motor will run in an anticlockwise direction (make sure that the motor has been designed to run in both directions).

If the motor is fitted with accessories (thermal protection or space heater), these must be connected on screw dominos with labelled wires.

Tightening torque for the nuts on the terminal blocks.

Terminal	M4	M5	M6	M8	M10	M12	M16
Torque N.m	1	2.5	4	10	20	35	65

LS / LSES series	230/400V connections		400/690V connections
	No. of poles	Terminals	Terminals
56 to 71	2; 4; 6	M4	-
80 to 112	2; 4; 6	M5	M5
132 S/SU	2; 4; 6	M5	M5
132 SM/M/MU	2; 4; 6	M6	M6
160	2; 4; 6	M6	M6
180 M/MT/L	2; 4; 6	M6	M6
180 MR/LR	4; 6	M8	M6
180 LUR	4	M8	M6
	6	M6	M6
200 L/LU	2; 6	M8	M8
200 LR	2; 4; 6	M8	M6
225 ST/SG/SR	4	M10	M8
225 MT	2	M10	M8
225 MR	2; 4	M8	M8
225 MG	4	M10	M8
	6	M8	M8
250 ME	4	M10	M10
	6	M8	M8
250 MZ	2	M10	M8
280 SC	2	M12	M10
	6	M10	M8
280 MC	2	M12	M10
280 SD	4	M12	M10
280 MD	4	M12	M10
	6	M10	M10
315 SN	2	M16	M12
315 SP	4	M16	M12
	6	M12	M10
	6	M12	M10
315 MP	2; 4; 6	M16	M12
	2	M16	M16
	2	M16	M12
315 MR	2	M16	M12
	2; 4	M16	M16
	6	M16	M12

Electro_Motor.ir

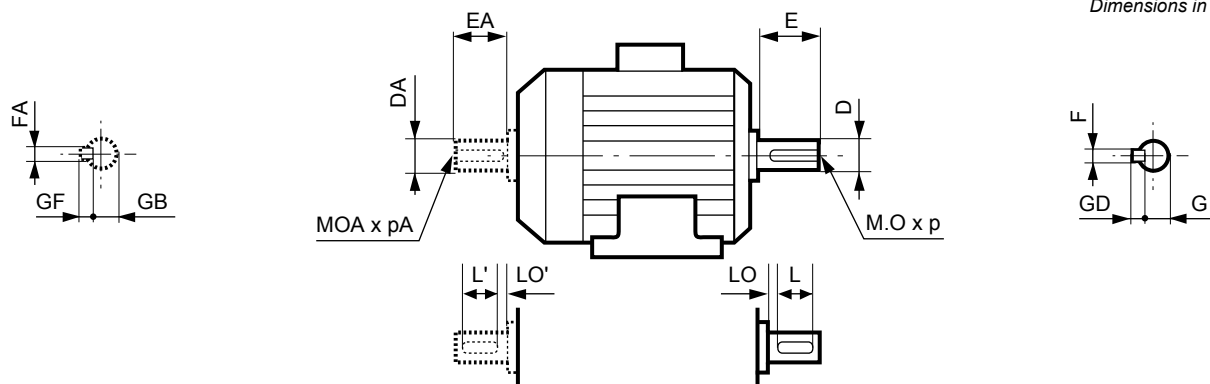

Dimensions in millimetres

IP55 ALUMINIUM MOTORS

Type	Main shaft extensions																	
	4 and 6 poles									2 poles								
	F	GD	D	G	E	O	p	L	LO	F	GD	D	G	E	O	p	L	LO
LS 56 M	3	3	9j6	7	20	4	10	16	3	3	3	9j6	7	20	4	10	16	3
LS 63 M	4	4	11j6	8.5	23	4	10	18	3.5	4	4	11j6	8.5	23	4	10	18	3.5
LS 71 M/L	5	5	14j6	11	30	5	15	25	3.5	5	5	14j6	11	30	5	15	25	3.5
LSES 80 L/LG [†]	6	6	19j6	15.5	40	M6	16	30	6	6	6	19j6	15.5	40	M6	16	30	6
LSES 90 L/LU/SL [†]	8	7	24j6	20	50	M8	19	40	6	8	7	24j6	20	50	M8	19	40	6
LSES 100 L/LG/LR [†]	8	7	28j6	24	60	M10	22	50	6	8	7	28j6	24	60	M10	22	50	6
LSES 112 M/MG/MU [†]	8	7	28j6	24	60	M10	22	50	6	-	-	-	-	-	-	-	-	-
LSES 132 M/MU/S/SM/SU [†]	10	8	38k6	33	80	M12	28	63	10	10	8	38k6	33	80	M12	28	63	10
LSES 160 L/LUR/M/MP/MR/MU [†]	12	8	42k6	37	110	M16	36	100	6	12	8	42k6	37	110	M16	36	100	6
LSES 180 L/LR/LUR/M/MT [†]	14	9	48k6	42.5	110	M16	36	98	12	14	9	48k6	42.5	110	M16	36	98	12
LSES 200 L/LR/LU [†]	16	10	55m6	49	110	M20	42	97	13	16	10	55m6	49	110	M20	42	97	13
LSES 225 MG/MR [†]	18	11	60m6	53	140	M20	42	126	14	18	11	60m6	53	140	M20	42	97	13
LSES 225 MT [†]	-	-	-	-	-	-	-	-	-	16	10	55m6	49	110	M20	42	97	13
LSES 225 SR/ST [†]	18	11	60m6	53	140	M20	42	126	14	-	-	-	-	-	-	-	-	-
LSES 250 ME	18	11	65m6	58	140	M20	42	126	14	18	11	60m6	53	140	M20	42	126	14
LSES 250 MZ	-	-	-	-	-	-	-	-	-	18	11	60m6	53	140	M20	42	126	14
LSES 280 MC/MD/SC	20	12	75m6	67.5	140	M20	42	125	15	18	11	65m6	58	140	M20	42	126	14
LSES 280 SD	20	12	75m6	67.5	140	M20	42	125	15	-	-	-	-	-	-	-	-	-
LSES 315 MP/MR/SN/SP	22	14	80m6	71	170	M20	42	140	15	18	11	65m6	58	140	M20	42	126	14

Type	Secondary shaft extensions																	
	4 and 6 poles									2 poles								
	FA	GF	DA	GB	EA	OA	pA	L'	LO'	FA	GF	DA	GB	EA	OA	pA	L'	LO'
LS 56 M	3	3	9j6	7	20	4	10	16	3	3	3	9j6	7	20	4	10	16	3
LS 63 M	4	4	11j6	8.5	23	4	10	18	3.5	4	4	11j6	8.5	23	4	10	18	3.5
LS 71 M/L	5	5	14j6	11	30	5	15	25	3.5	5	5	14j6	11	30	5	15	25	3.5
LSES 80 L/LG [†]	5	5	14j6	11	30	M5	15	25	3.5	5	5	14j6	11	30	M5	15	25	3.5
LSES 90 L/LU/SL [†]	6	6	19j6	15.5	40	6	16	30	6	6	6	19j6	15.5	40	6	16	30	6
LSES 100 L/LG/LR [†]	8	7	24j6	20	50	8	19	40	6	8	7	24j6	20	50	8	19	40	6
LSES 112 M/MG/MU [†]	8	7	24j6	20	50	8	19	40	6	8	7	24j6	20	50	8	19	40	6
LSES 132 M/MU/S/SM/SU [†]	8	7	28k6	24	60	10	22	50	6	8	7	28k6	24	60	10	22	50	6
LSES 160 MP/MR [†]	10	8	38k6	33	80	12	28	63	10	10	8	38k6	33	80	12	28	63	10
LSES 160 L/LUR/M/MU [†]	12	8	42k6	37	110	16	36	100	6	12	8	42k6	37	110	16	36	100	6
LSES 180 L/LR/LUR/M/MT [†]	14	9	48k6	42.5	110	16	36	97	13	14	9	48k6	42.5	110	16	36	97	13
LSES 200 L/LR/LU [†]	16	10	55m6	49	110	20	42	97	13	16	10	55m6	49	110	20	42	97	13
LSES 225 MG/MR [†]	18	11	60m6	53	140	20	42	126	14	18	11	60m6	53	140	20	42	97	13
LSES 225 MT [†]	-	-	-	-	-	-	-	-	-	16	10	55m6	49	110	20	42	97	13
LSES 225 SR/ST [†]	18	11	60m6	53	140	20	42	125	15	-	-	-	-	-	-	-	-	-
LSES 250 ME	18	11	60m6	53	140	20	42	126	14	18	11	60m6	53	140	20	42	126	14
LSES 250 MZ	-	-	-	-	-	-	-	-	-	18	11	60m6	53	140	20	42	126	14
LSES 280 MC/MD/SC	18	11	65m6	58	140	20	42	126	14	18	11	65m6	58	140	20	42	126	14
LSES 280 SD	18	11	65m6	58	140	20	42	126	14	-	-	-	-	-	-	-	-	-
LSES 315 SN	20	12	75m6	67.5	140	20	42	125	15	18	11	65m6	58	140	20	42	125	14
LSES 315 MP/MR/SP	22	14	80m6	71	170	24	42	155	15	18	11	65m6	58	140	20	42	126	14

[†] the dimensions of frame sizes 80 to 225 motors concern the types LS and LSES

IMfinity® 3-phase induction motors - IE2 - IE3 - IE4 - Non IE Efficiency

IP55 Aluminium frame

Dimensions

Foot mounted IM 1001 (IM B3)

Dimensions in millimetres

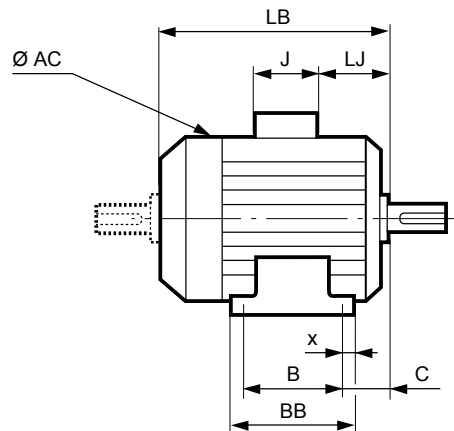
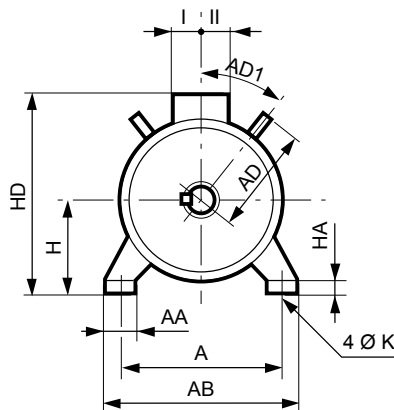

Type	Main dimensions																		
	A	AB	B	BB	C	x	AA	K	HA	H	AC*	HD	LB	LJ	J	I	II	AD	AD1
LS 56 M	90	104	71	87	36	8	24	6	7	56	110	140	156	16	86	43	43	-	-
LS 63 M	100	115	80	96	40	8	26	7	9	63	124	152	172	26	86	43	43	-	-
LS 71 M/L	112	126	90	106	45	8	24	7	9	71	140	170	193	21	86	43	43	-	-
LSES 80 L ¹	125	157	100	120	50	10	29	9	10	80	170	207	215	23.5	90	53	53	-	-
LSES 80 LG ¹	125	157	100	125	50	14	31	9	10	80	189	217	247	23.5	90	53	53	-	-
LSES 90 L ¹	140	172	125	164	56	28	39	10	11	90	189	227	245	23.5	90	53	53	-	-
LSES 90 LU ¹	140	172	125	164	56	28	39	10	11	90	189	227	276	23.5	90	53	53	-	-
LSES 90 SL ¹	140	172	125	164	56	28	39	10	11	90	189	227	245	23.5	90	53	53	-	-
LSES 100 L ¹	160	196	140	165	63	12	40	12	13	100	200	242	290	23.5	90	53	53	118	45
LSES 100 LG ¹	160	196	140	168	63	13	40	12	14	100	227	251	305	22.5	90	53	53	130	45
LSES 100 LR ¹	160	196	140	165	63	12	40	12	13	100	200	242	309	23.5	90	53	53	118	45
LSES 112 M ¹	190	220	140	165	70	13	44	12	14	112	200	254	290	23.5	90	53	53	118	45
LSES 112 MG ¹	190	220	140	165	60	12	52	12	14	112	235	263	305	22.5	90	53	53	-	-
LSES 112 MU ¹	190	220	140	165	60	12	52	12	14	112	235	263	322	22.5	90	53	53	-	-
LSES 132 M ¹	216	250	178	208	89	15	50	12	15	132	272	322	385	16.5	126	63	63	140	45
LSES 132 MU ¹	216	250	178	208	89	15	50	12	15	132	272	322	412	16.5	126	63	63	140	45
LSES 132 S ¹	216	250	140	170	89	15	42	12	16	132	227	304	351	32	126	63	63	130	45
LSES 132 SU ¹	216	250	140	208	89	15	50	12	15	132	272	322	385	16.5	126	63	63	140	45
LSES 160 L ¹	254	294	254	294	108	20	60	14.5	25	160	312	395	495	44	134	92	63	186	45
LSES 160 LR ¹	254	294	254	294	108	20	60	14.5	25	160	312	395	510	44	134	92	63	186	45
LSES 160 M ¹	254	294	210	294	108	20	60	14.5	25	160	312	395	495	44	134	92	63	186	45
LSES 160 MP ¹	254	294	210	294	108	20	64	14	25	160	272	350	468	59	126	63	63	156	45
LSES 160 MR ¹	254	294	210	294	108	20	64	14	25	160	272	350	495	59	126	63	63	156	45
LSES 160 MU ¹	254	294	210	294	108	20	60	14.5	25	160	312	395	510	44	134	92	63	186	45
LSES 180 L ¹	279	339	279	329	121	25	86	14.5	25	180	350	436	552	64	186	112	98	-	-
LSES 180 LR ¹	279	324	279	316	121	20	79	14.5	28	180	312	428	520	55	186	112	98	186	45
LSES 180 LUR ¹	279	339	279	329	121	25	86	14.5	25	180	350	436	614	64	186	112	98	-	-
LSES 180 M ¹	279	339	241	291	121	25	86	14.5	25	180	350	436	552	64	186	112	98	-	-
LSES 180 MR ¹	279	324	279	316	121	20	79	14.5	28	180	312	428	520	55	186	112	98	186	45
LSES 180 MT ¹	279	324	241	316	121	20	79	14.5	28	180	312	428	495	55	186	112	98	186	45
LSES 200 L ¹	318	388	305	375	133	35	103	18.5	36	200	390	476	620.5	77	186	112	98	-	-
LSES 200 LR ¹	318	378	305	365	133	30	108	18.5	30	200	350	456	620	70	186	112	98	-	-
LSES 200 LU ¹	318	388	305	375	133	35	103	18.5	36	200	390	476	669.5	77	186	112	98	-	-
LSES 225 MG ¹	356	420	311	375	149	30	65	18.5	33	225	479	630	810	68	292	151	181	283	45
LSES 225 MR ¹	356	431	311	386	149	50	127	18.5	36	225	390	535	676	61	231	119	141	-	-
LSES 225 MT ¹	356	431	311	386	149	50	127	18.5	36	225	390	535	627	61	231	119	141	-	-
LSES 225 SR ¹	356	431	286	386	149	50	127	18.5	36	225	390	535	676	61	231	119	141	-	-
LSES 225 ST ¹	356	431	286	386	149	50	127	18.5	36	225	390	535	627	61	231	119	141	-	-
LSES 250 ME	406	470	349	420	168	35	90	24	35	250	479	655	810	68	292	151	181	283	45
LSES 250 MZ	406	470	349	449	168	70	150	24	47	250	390	560	676	61	231	119	141	-	-
LSES 280 MC	457	520	419	478	190	35	90	24	35	280	479	685	810	68	292	151	181	283	45
LSES 280 MD	457	520	419	478	190	35	90	24	35	280	479	685	870	68	292	151	181	283	45
LSES 280 SC	457	520	368	478	190	35	90	24	35	280	479	685	810	68	292	151	181	283	45
LSES 280 SD	457	520	368	478	190	35	90	24	35	280	479	685	870	68	292	151	181	283	45
LSES 315 MP	508	594	457	537	216	40	114	28	70	315	586	870	947	61	420	180	233	-	-
LSES 315 MR	508	594	457	537	216	40	114	28	70	315	586	870	1017	61	420	180	233	-	-
LSES 315 SN	508	594	406	537	216	40	140	28	50	315	479	720	870	68	292	151	181	283	45
LSES 315 SP	508	594	406	537	216	40	114	28	70	315	586	870	947	61	420	180	233	-	-

* AC: housing diameter without lifting rings

1. The dimensions of frame sizes 80 to 225 motors concern the types LS and LSES

IMfinity® 3-phase induction motors - IE2 - IE3 - IE4 - Non IE Efficiency

IP55 Aluminium frame

Dimensions

Foot and flange IM 2001 (IM B35)

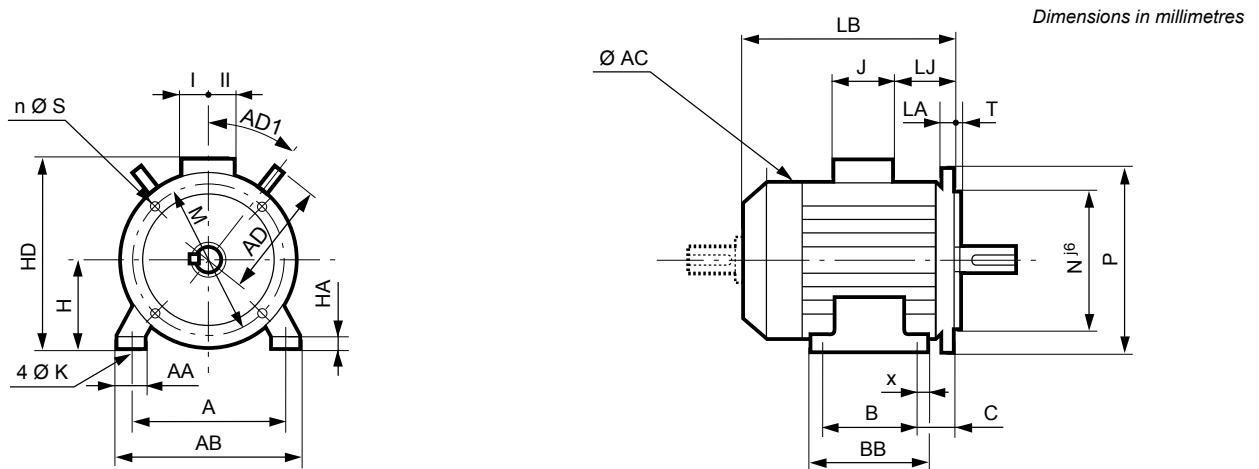

Type	Main dimensions																			Symb
	A	AB	B	BB	C	x	AA	K	HA	H	AC*	HD	LB	LJ	J	I	II	AD	AD1	
LS 56 M	90	104	71	87	36	8	25	6	7	56	110	140	156	16	86	43	43	-	-	FF 100
LS 63 M	100	115	80	96	40	8	26	7	9	63	124	152	172	26	86	43	43	-	-	FF 115
LS 71 M/L	112	125	90	106	45	8	24	7	9	71	140	170	193	26	86	43	43	-	-	FF 130
LSES 80 L [†]	125	157	100	120	50	10	29	9	10	80	170	207	215	23.5	90	53	53	-	-	FF165
LSES 80 LG [†]	125	157	100	125	50	14	31	9	10	80	189	217	247	23.5	90	53	53	-	-	FF165
LSES 90 L [†]	140	172	125	164	56	28	39	10	11	90	189	227	245	23.5	90	53	53	-	-	FF165
LSES 90 LU [†]	140	172	125	164	56	28	39	10	11	90	189	227	276	23.5	90	53	53	-	-	FF165
LSES 90 SL [†]	140	172	125	164	56	28	39	10	11	90	189	227	245	23.5	90	53	53	-	-	FF165
LSES 100 L [†]	160	196	140	165	63	12	40	12	13	100	200	242	290	23.5	90	53	53	118	45	FF215
LSES 100 LG [†]	160	196	140	168	63	13	40	12	14	100	227	251	305	22.5	90	53	53	130	45	FF215
LSES 100 LR	160	196	140	165	63	12	40	12	13	100	200	242	309	23.5	90	53	53	118	45	FF215
LSES 112 M [†]	190	220	140	165	70	13	44	12	14	112	200	254	290	23.5	90	53	53	118	45	FF215
LSES 112 MG [†]	190	220	140	165	60	12	52	12	14	112	235	263	305	22.5	90	53	53	-	-	FF215
LSES 112 MU [†]	190	220	140	165	60	12	52	12	14	112	235	263	322	22.5	90	53	53	-	-	FF215
LSES 132 M [†]	216	250	178	208	89	15	50	12	15	132	272	322	385	16.5	126	63	63	140	45	FF265
LSES 132 MU [†]	216	250	178	208	89	15	50	12	15	132	272	322	412	16.5	126	63	63	140	45	FF265
LSES 132 S [†]	216	250	140	170	89	15	42	12	16	132	227	304	351	32	126	63	63	130	45	FF265
LSES 132 SU [†]	216	250	140	170	89	15	42	12	16	132	227	304	383	32	126	63	63	130	45	FF265
LSES 160 L [†]	254	294	254	294	108	20	60	14.5	25	160	312	395	495	44	134	92	63	186	45	FF300
LSES 160 LUR [†]	254	294	254	294	108	20	60	14.5	25	160	312	395	510	44	134	92	63	186	45	FF300
LSES 160 M [†]	254	294	210	294	108	20	60	14.5	25	160	312	395	495	44	134	92	63	186	45	FF300
LSES 160 MP [†]	254	294	210	294	108	20	64	14	25	160	272	350	468	59	126	63	63	156	45	FF300
LSES 160 MR [†]	254	294	210	294	108	20	64	14	25	160	272	350	495	59	126	63	63	156	45	FF300
LSES 160 MU [†]	254	294	210	294	108	20	60	14.5	25	160	312	395	510	44	134	92	63	186	45	FF300
LSES 180 L [†]	279	339	279	329	121	25	86	14.5	25	180	350	436	552	64	186	112	98	-	-	FF300
LSES 180 LR [†]	279	324	279	316	121	20	79	14.5	28	180	312	428	520	55	186	112	98	186	45	FF300
LSES 180 LUR [†]	279	339	279	329	121	25	86	14.5	25	180	350	436	614	64	186	112	98	-	-	FF300
LSES 180 M [†]	279	339	241	291	121	25	86	14.5	25	180	350	436	552	64	186	112	98	-	-	FF300
LSES 180 MR [†]	279	324	279	316	121	20	79	14.5	28	180	312	428	520	55	186	112	98	186	45	FF300
LSES 180 MT [†]	279	324	241	316	121	20	79	14.5	28	180	312	428	495	55	186	112	98	186	45	FF300
LSES 200 L [†]	318	388	305	375	133	35	103	18.5	36	200	390	476	620.5	77	186	112	98	-	-	FF350
LSES 200 LR [†]	318	378	305	365	133	30	108	18.5	30	200	350	456	620	70	186	112	98	-	-	FF350
LSES 200 LU [†]	318	388	305	375	133	35	103	18.5	36	200	390	476	669.5	77	186	112	98	-	-	FF350
LSES 225 MG [†]	356	420	311	375	149	30	65	18.5	33	225	479	630	810	68	292	151	181	283	45	FF400
LSES 225 MR [†]	356	431	311	386	149	50	127	18.5	36	225	390	535	676	61	231	119	141	-	-	FF400
LSES 225 MT [†]	356	431	311	386	149	50	127	18.5	36	225	390	535	627	61	231	119	141	-	-	FF400
LSES 225 SR [†]	356	431	286	386	149	50	127	18.5	36	225	390	535	676	61	231	119	141	-	-	FF400
LSES 225 ST [†]	356	431	286	386	149	50	127	18.5	36	225	390	535	627	61	231	119	141	-	-	FF400
LSES 250 ME	406	470	349	420	168	35	90	24	35	250	479	655	810	68	292	151	181	283	45	FF500
LSES 250 MZ	406	470	349	449	168	70	150	24	47	250	390	560	676	61	231	119	141	-	-	FF500
LSES 280 MC	457	520	419	478	190	35	90	24	35	280	479	685	810	68	292	151	181	283	45	FF500
LSES 280 MD	457	520	419	478	190	35	90	24	35	280	479	685	870	68	292	151	181	283	45	FF500
LSES 280 SC	457	520	368	478	190	35	90	24	35	280	479	685	810	68	292	151	181	283	45	FF500
LSES 280 SD	457	520	368	478	190	35	90	24	35	280	479	685	870	68	292	151	181	283	45	FF500
LSES 315 MP	508	594	457	537	216	40	114	28	70	315	586	870	947	61	420	180	233	-	-	FF600
LSES 315 MR	508	594	457	537	216	40	114	28	70	315	586	870	1017	61	420	180	233	-	-	FF600
LSES 315 SN	508	594	406	537	216	40	140	28	50	315	479	720	870	68	292	151	181	283	45	FF600
LSES 315 SP	508	594	406	537	216	40	114	28	70	315	586	870	947	61	420	180	233	-	-	FF600

* AC: housing diameter without lifting rings

1. The dimensions of frame sizes 80 to 225 motors concern the types LS and LSES

IP55 ALUMINIUM MOTORS

IMfinity® 3-phase induction motors - IE2 - IE3 - IE4 - Non IE Efficiency

IP55 Aluminium frame

Dimensions

Flange mounted IM 3001 (IM B5) IM 3011 (IM V1)

Dimensions in millimetres

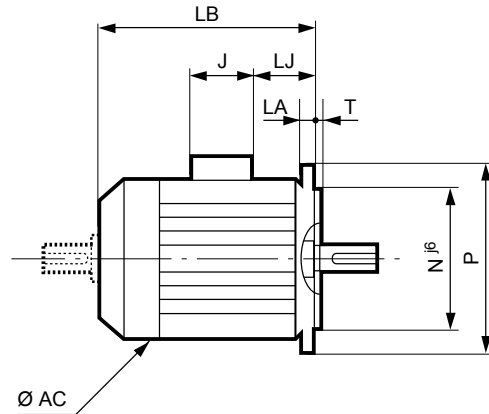
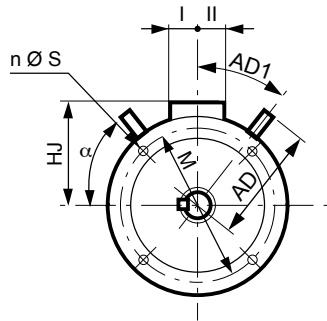

Type	Main dimensions									
	AC*	LB	HJ	LJ	J	I	II	AD	AD1	
LS 56 M	110	156	84	16	86	43	43	-	-	
LS 63 M	124	172	89	26	96	43	43	-	-	
LS 71 M/L	140	193	99	26	86	43	43	-	-	
LSES 80 L [†]	170	215	127	23.5	90	53	53	-	-	
LSES 80 LG [†]	189	267	137	43.5	90	53	53	-	-	
LSES 90 L [†]	189	265	137	43.5	90	53	53	-	-	
LSES 90 LU [†]	189	296	137	43.5	90	53	53	-	-	
LSES 90 SL [†]	189	265	137	43.5	90	53	53	-	-	
LSES 100 L [†]	200	290	142	23.5	90	53	53	-	-	
LSES 100 LG [†]	235	305	151	23.5	90	53	53	-	-	
LSES 100 LR [†]	200	309	142	23.5	90	53	53	-	-	
LSES 112 M [†]	200	290	142	23.5	90	53	53	-	-	
LSES 112 MG [†]	235	315	151	33.5	90	53	53	-	-	
LSES 112 MU [†]	235	332	151	33.5	90	53	53	-	-	
LSES 132 M [†]	272	385	190	16.5	126	63	63	140	45	
LSES 132 MU [†]	272	412	190	16.5	126	63	63	140	45	
LSES 132 S [†]	227	351	172	32	126	63	63	130	45	
LSES 132 SM [†]	272	385	190	16.5	126	63	63	140	45	
LSES 132 SU [†]	227	383	172	32	126	63	63	130	45	
LSES 160 L [†]	312	495	235	44	134	92	63	186	45	
LSES 160 LUR [†]	312	510	235	44	134	92	63	186	45	
LSES 160 M [†]	312	495	235	45	134	92	63	186	45	
LSES 160 MP [†]	272	468	190	59	126	63	63	186	45	
LSES 160 MR [†]	272	495	190	59	126	63	63	186	45	
LSES 160 MU [†]	312	510	235	45	134	92	63	186	45	
LSES 180 L [†]	350	552	256	64	186	112	98	-	-	
LSES 180 LR [†]	312	520	248	54	186	112	98	186	45	
LSES 180 LUR [†]	350	614	256	64	186	112	98	-	-	
LSES 180 M [†]	350	552	256	64	186	112	98	-	-	
LSES 180 MR [†]	312	520	248	54	186	112	98	186	45	
LSES 180 MT [†]	312	495	248	54	186	112	98	186	45	
LSES 200 L [†]	390	620.5	276	77.5	186	112	98	-	-	
LSES 200 LR [†]	350	620	256	70	186	112	98	-	-	
LSES 200 LU	390	669.5	276	77.5	186	112	98	-	-	
LSES 225 MG [†]	479	810	405	68	292	151	181	283	45	
LSES 225 MR [†]	390	676	310	61	231	119	141	-	-	
LSES 225 MT [†]	390	627	310	61	231	119	141	-	-	
LSES 225 SR [†]	390	676	310	61	231	119	141	-	-	
LSES 225 ST [†]	390	627	310	61	231	119	141	-	-	
LSES 250 ME	479	810	405	68	292	151	181	283	45	
LSES 250 MZ	390	676	310	61	231	119	141	-	-	
LSES 280 MC	479	810	405	68	292	151	181	283	45	
LSES 280 MD	479	870	405	68	292	151	181	283	45	
LSES 280 SC	479	810	405	68	292	151	181	283	45	
LSES 280 SD	479	870	405	68	292	151	181	283	45	
LSES 315 MP	586	947	555	61	420	180	233	-	-	
LSES 315 MR	586	1017	555	61	420	180	233	-	-	
LSES 315 SN	479	870	405	68	292	151	181	283	45	
LSES 315 SP	586	947	555	61	420	180	233	-	-	

IEC symbol	Flange dimensions							
	M	N	P	T	n	α°	S	LA
FF 100	100	80	120	2.5	4	45	7	5
FF 115	115	95	140	3	4	45	10	10
FF 130	130	110	160	3.5	4	45	10	10
FF165	165	130	200	3.5	4	45	12	10
FF165	165	130	200	3.5	4	45	12	10
FF165	165	130	200	3.5	4	45	12	10
FF165	165	130	200	3.5	4	45	12	10
FF165	165	130	200	3.5	4	45	12	10
FF215	215	180	250	4	4	45	14.5	12
FF215	215	180	250	4	4	45	14.5	12
FF215	215	180	250	4	4	45	14.5	12
FF215	215	180	250	4	4	45	14.5	12
FF215	215	180	250	4	4	45	14.5	13
FF215	215	180	250	4	4	45	14.5	13
FF265	265	230	300	4	4	45	14.5	14
FF265	265	230	300	4	4	45	14.5	14
FF265	265	230	300	4	4	45	14.5	14
FF265	265	230	300	4	4	45	14.5	14
FF265	265	230	300	4	4	45	14.5	14
FF300	300	250	350	5	4	45	18.5	15
FF300	300	250	350	5	4	45	18.5	15
FF300	300	250	350	5	4	45	18.5	14
FF300	300	250	350	5	4	45	18.5	14
FF300	300	250	350	5	4	45	18.5	15
FF300	300	250	350	5	4	45	18.5	15
FF300	300	250	350	5	4	45	18.5	15
FF300	300	250	350	5	4	45	18.5	15
FF300	300	250	350	5	4	45	18.5	15
FF300	300	250	350	5	4	45	18.5	15
FF350	350	300	400	5	4	45	18.5	15
FF350	350	300	400	5	4	45	18.5	15
FF350	350	300	400	5	4	45	18.5	15
FF400	400	350	450	5	8	22.5	18.5	16
FF400	400	350	450	5	8	22.5	18.5	16
FF400	400	350	450	5	8	22.5	18.5	16
FF400	400	350	450	5	8	22.5	18.5	16
FF400	400	350	450	5	8	22.5	18.5	16
FF500	500	450	550	5	8	22.5	18.5	22
FF500	500	450	550	5	8	22.5	18.5	18
FF500	500	450	550	5	8	22.5	18.5	22
FF500	500	450	550	5	8	22.5	18.5	22
FF500	500	450	550	5	8	22.5	18.5	22
FF600	600	550	660	6	8	22.5	24	22
FF600	600	550	660	6	8	22.5	24	22
FF600	600	550	660	6	8	22.5	24	22
FF600	600	550	660	6	8	22.5	24	22

* AC: housing diameter without lifting rings

1. The dimensions of frame sizes 80 to 225 motors concern the types LS and LSES

For a frame size ≥ 250 mm for IM 3001 use, please consult Nidec Leroy-Somer
 Dimensions of shaft extensions identical to those for foot mounted motors

Electro_Motor.ir

IMfinity® 3-phase induction motors - IE2 - IE3 - IE4 - Non IE Efficiency

IP55 Aluminium frame

Dimensions

Foot and face IM 2101 (IM B34)

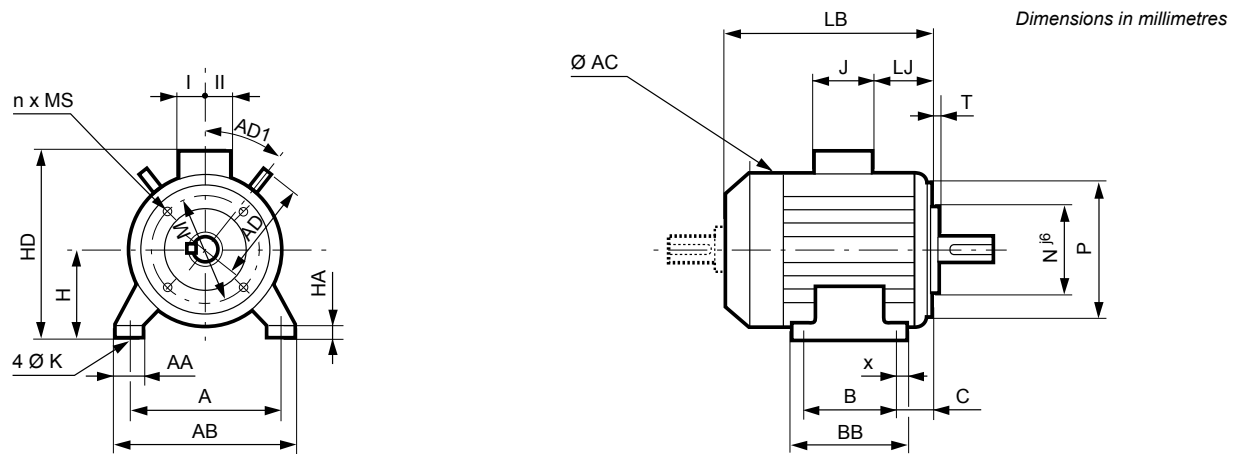

Type	Main dimensions																			
	A	AB	B	BB	C	x	AA	K	HA	H	AC*	HD	LB	LJ	J	I	II	AD	AD1	Symb
LS 56 M	90	104	71	87	36	8	25	6	7	56	110	140	156	16	86	43	43	-	-	FT65
LS 63 M	100	115	80	96	40	8	26	7	9	63	124	152	172	26	86	43	43	-	-	FT75
LS 71 M/L	112	126	90	106	45	8	24	7	9	71	140	170	193	26	86	43	43	-	-	FT85
LSES 80 L ¹	125	157	100	120	50	10	29	9	10	80	170	205	215	26	86	43	43	-	-	FT100
LSES 80 LG ¹	125	157	100	125	50	14	31	9	10	80	189	215	247	26	86	43	43	-	-	FT100
LSES 90 L ¹	140	172	125	164	56	28	39	10	11	90	189	225	245	26	86	43	43	-	-	FT115
LSES 90 LU ¹	140	172	125	164	56	28	39	10	11	90	189	225	276	26	86	43	43	-	-	FT115
LSES 90 SL ¹	140	172	125	164	56	28	39	10	11	90	189	225	245	26	86	43	43	-	-	FT115
LSES 100 L ¹	160	196	140	165	63	12	40	12	13	100	200	240	290	26	86	43	43	118	45	FT130
LSES 100 LG ¹	160	196	140	168	63	13	40	12	14	100	227	249	315	35	86	43	43	130	45	FT130
LSES 100 LR ¹	160	196	140	165	63	12	40	12	13	100	200	240	309	26	86	43	43	118	45	FT130
LSES 112 M ¹	190	220	140	165	70	13	44	12	14	112	200	254	290	23.5	90	53	53	118	45	FT130
LSES 112 MG ¹	190	220	140	165	70	12	52	12	14	112	235	261	315	35	86	43	43	-	-	FT130
LSES 112 MU ¹	190	220	140	165	70	12	52	12	14	112	235	261	332	35	86	43	43	-	-	FT130
LSES 132 M ¹	216	250	178	208	89	15	50	12	15	132	272	322	385	17	126	63	63	140	45	FT165
LSES 132 MU ¹	216	250	178	208	89	15	50	12	15	132	272	322	412	17	126	63	63	140	45	FT165
LSES 132 S ¹	216	250	140	170	89	15	42	12	16	132	227	304	351	32	126	63	63	130	45	FT165
LSES 132 SM ¹	216	250	140	208	89	15	50	12	15	132	272	322	385	17	126	63	63	140	45	FT165
LSES 132 SU ¹	216	250	140	170	89	15	42	12	16	132	227	304	383	32	126	63	63	130	45	FT165
LSES 160 MP ¹	254	294	210	294	108	20	64	14	25	160	272	350	468	59	126	63	63	156	45	FT215
LSES 160 MR ¹	254	294	210	294	108	20	64	14	25	160	272	350	495	59	126	63	63	156	45	FT215

* AC: housing diameter without lifting rings

1. The dimensions of frame sizes 80 to 225 motors concern the types LS and LSES

IMfinity® 3-phase induction motors - IE2 - IE3 - IE4 - Non IE Efficiency

IP55 Aluminium frame

Dimensions

Face mounted IM 3601 (IM B14)

IP55 ALUMINIUM MOTORS

Dimensions in millimetres

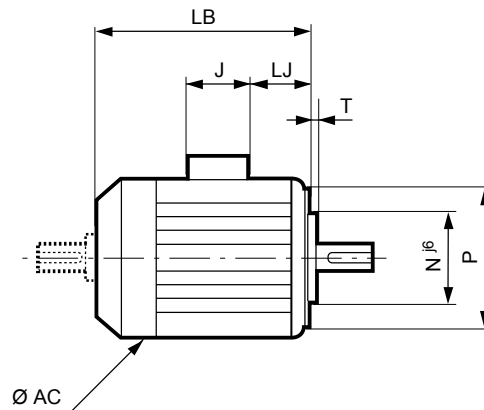
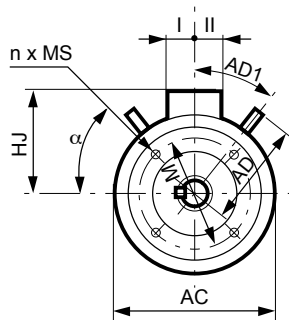

Type	Main dimensions								
	AC*	LB	HJ	LJ	J	I	II	AD	AD1
LS 56 M	110	156	84	16	86	43	43	-	-
LS 63 M	134	172	89	26	86	43	43	-	-
LS 71 M/L	140	193	99	21	86	43	43	-	-
LSES 80 L [†]	170	215	125	26	86	43	43	-	-
LSES 80 LG [†]	189	247	135	26	86	43	43	-	-
LSES 90 L [†]	189	245	135	26	86	43	43	-	-
LSES 90 LU [†]	189	276	135	26	86	43	43	-	-
LSES 90 SL [†]	189	245	135	26	86	43	43	-	-
LSES 100 L [†]	200	290	140	26	86	43	43	118	45
LSES 100 LG [†]	227	315	149	35	86	43	43	130	45
LSES 100 LR [†]	200	309	140	26	86	43	43	118	45
LSES 112 M [†]	200	290	142	23.5	90	53	53	-	-
LSES 112 MG [†]	235	315	149	35	86	43	43	-	-
LSES 112 MU [†]	235	332	149	35	86	43	43	-	-
LSES 132 M [†]	272	385	190	17	126	63	63	140	45
LSES 132 MU [†]	272	412	190	17	126	63	63	140	45
LSES 132 S [†]	227	351	172	32	126	63	63	130	45
LSES 132 SM [†]	272	385	190	17	126	63	63	140	45
LSES 132 SU [†]	227	383	172	32	126	63	63	130	45
LSES 160 MP [†]	272	468	190	59	126	63	63	156	45
LSES 160 MR [†]	272	495	190	59	126	63	63	156	45

IEC symbol	Flange dimensions						
	M	N	P	T	n	α°	MS
FT 65	65	50	80	2.5	4	45	M5
FT 75	75	60	90	2.5	4	45	M5
FT 85	85	70	105	2.5	4	45	M6
FT100	100	80	120	3	4	45	M6
FT100	100	80	120	3	4	45	M6
FT115	115	95	140	3	4	45	M8
FT115	115	95	140	3	4	45	M8
FT115	115	95	140	3	4	45	M8
FT130	130	110	160	3.5	4	45	M8
FT130	130	110	160	3.5	4	45	M8
FT130	130	110	160	3.5	4	45	M8
FT130	130	110	160	3.5	4	45	M8
FT130	130	110	160	3.5	4	45	M8
FT130	130	110	160	3.5	4	45	M8
FT165	165	130	200	3.5	4	45	M10
FT165	165	130	200	3.5	4	45	M10
FT165	165	130	200	3.5	4	45	M10
FT165	165	130	200	3.5	4	45	M10
FT215	215	180	250	4	4	45	M12
FT215	215	180	250	4	4	45	M12

* AC: housing diameter without lifting rings

1. The dimensions of frame sizes 80 to 225 motors concern the types LS and LSES

Electro_Motor.ir

PERMANENTLY GREASED BEARINGS

Under normal operating conditions, the service life in hours of the bearing is indicated in the table below for ambient temperatures less than 55°C.

Series	Type	No. of poles	Types of permanently greased bearing		Bearing life according to speed of rotation									
					3000 min ⁻¹			1500 min ⁻¹			1000 min ⁻¹			
					25°C	40°C	55°C	25°C	40°C	55°C	25°C	40°C	55°C	
LS	56 M	2; 4; 6	6201 C3	6201 C3	>40000	>40000	>40000	>40000	>40000	>40000	>40000	>40000	38500	
	63 M	2; 4; 6	6201 C3	6202 C3	>40000	>40001	>40002	>40003	>40004	>40005	>40006	>40007	>40008	
	71 M/L													
LS / LSES	80 L	2	6203 CN	6204 C3	≥40000	≥40000	25000	-	-	-	-	-	-	
	80 LG	2; 4	6204 C3	6205 C3	≥40000	≥40000	24000	≥40000	≥40000	31000	≥40000	≥40000	34000	
	90 SL/L	2; 4; 6			-	-	-	≥40000	≥40000	30000	-	-	-	
	90 LU	4	6205 C3	6205 C3	-	-	-	≥40000	≥40000	30000	-	-	-	
	100 L	2; 4; 6	6205 C3	6206 C3	≥40000	≥40000	22000	≥40000	≥40000	30000	≥40000	≥40000	33000	
	100 LR	4			-	-	-	≥40000	≥40000	30000	-	-	-	
	112 M	2	6205 C3	6206 C3	≥40000	≥40000	22000	-	-	-	-	-	-	
	112 MG	2; 6			-	-	-	≥40000	≥40000	30000	≥40000	≥40000	33000	
	112 MU	4	6206 C3	6206 C3	-	-	-	≥40000	≥40000	30000	-	-	-	
	132 S	2; 6	6206 C3	6208 C3	≥40000	≥40000	19000	-	-	-	≥40000	≥40000	30000	
	132 SU	2; 4			≥40000	≥40000	19000	≥40000	≥40000	25000	-	-	-	
	132 SM/M	2; 4; 6	6207 C3	6308 C3	≥40000	≥40000	19000	≥40000	≥40000	25000	≥40000	≥40000	30000	
	132 MU	4; 6	6307 C3	6308 C3	-	-	-	≥40000	≥40000	25000	≥40000	≥40000	30000	
	160 MR	2; 4	6308 C3	6309 C3	≥40000	35000	15000	≥40000	≥40000	24000	-	-	-	
	160 MP	2; 4	6208 C3	6309 C3	≥40000	35000	18000	≥40000	≥40000	24000	-	-	-	
	160 M/MU	6	6210 C3	6309 C3	-	-	-	-	-	-	-	≥40000	≥40000	27000
	160 L	2; 4; 6			≥40000	30000	15000	≥40000	≥40000	23000	≥40000	≥40000	27000	
	160 LUR	4; 6	6210 C3	6310 C3	-	-	-	≥40000	≥40000	23000	≥40000	≥40000	27000	
	180 MT	2; 4			≥40000	30000	15000	≥40000	≥40000	23000	-	-	-	
	180 M	4	6212 C3	6310 C3	-	-	-	≥40000	≥40000	24900	-	-	-	
	180 L	6			-	-	-	-	-	-	≥40000	≥40000	28000	
	180 LR	4	6210 C3	6310 C3	-	-	-	≥40000	≥40000	23000	-	-	-	
	180 LUR	4; 6	6312 C3	6310 C3	-	-	-	≥40000	≥40000	22000	≥40000	≥40000	27000	
	200 L	2; 6	6214 C3	6312 C3	≥40000	25000	12500	-	-	-	≥40000	≥40000	27000	
	200 LR	2; 4; 6	6312 C3	6312 C3	≥40000	25000	12500	-	-	-	≥40000	≥40000	27000	
	200 LU	4; 6			-	-	-	≥40000	≥40000	22000	≥40000	≥40000	27000	
	225 ST	4	6214 C3	6313 C3	-	-	-	≥40000	≥40000	21000	-	-	-	
225 MT	2	≥40000			22000	11000	-	-	-	-	-	-		
225 SR	4	6312 C3	6313 C3	-	-	-	≥40000	≥40000	21000	-	-	-		
225 MR	2; 4; 6			≥40000	22000	11000	≥40000	≥40000	20000	≥40000	≥40000	26000		
225 MG	4; 6	6216 C3	6314 C3	-	-	-	≥40000	≥40000	20000	≥40000	≥40000	25000		

BEARINGS WITH GREASE NIPPLES

The chart opposite shows the greasing intervals, depending on the type of motor, for standard bearing assemblies of frame size ≥ 160 mm fitted with grease nipples, operating at an ambient temperature of 25°C, 40°C and 55°C on a horizontal shaft machine

SPECIAL CONSTRUCTION AND ENVIRONMENT

For vertical shaft machines, the greasing intervals will be approximately 80% of the values stated in the table below.

Note: The quality and quantity of grease and the greasing interval are shown on the machine nameplate.

For special assemblies (motors fitted with DE roller bearings or other types), machines of frame size ≥ 160 mm have bearings with grease nipples.

Instructions for bearing maintenance are given on the nameplates on these machines.

The chart below is valid for motors lubricated with Polyrex EM103 grease, which is used as standard

Series	Type	No. of poles	Type of bearings for greaser bearing bush		Quantity of grease g	Greasing intervals in hours									
			N.D.E.	D.E.		3000 min ⁻¹			1500 min ⁻¹			1000 min ⁻¹			
						25°C	40°C	55°C	25°C	40°C	55°C	25°C	40°C	55°C	
LS / LSES	160 M/MU*	2; 4; 6	6210 C3	6309 C3	13	22200	11100	5550	32400	16200	8100	39800	19900	9950	
	160 L*														
	180 MR*	2	6210 C3	6310 C3	15	19600	9800	4900	-	-	-	-	-	-	
	180 MT*	2; 4							30400	15200	7600	-	-	-	-
	180 LR*	4													
	180 LUR*	4; 6	6312 C3	6310 C3	20	-	-	-	26800	13400	6700	35000	17500	8750	
	180 M*	4	6212 C3	6310 C3	15	-	-	-	29200	14600	7300	-	-	-	
	180 L*	6							-	-	-	37200	18600	9300	
	200 LR*	2; 4; 6	6312 C3	6312 C3	20	15200	7600	3800	26800	13400	6700	35000	17500	8750	
	200 LU*	4; 6							-	-	-				
	200 L*	2; 6	6214 C3	6312 C3	20	14600	7300	3650	-	-	-	34600	17300	8650	
	225 ST*	4	6214 C3	6313 C3	25	-	-	-	25200	12600	6300	-	-	-	
	225 MT*	2							10600	5300	2650	-	-	-	-
	225 SR/MR*	2; 4; 6	6312 C3	6313 C3	25	13400	6700	3350	25200	12600	6300	33600	16800	8400	
	225 MG*	4; 6	6216 C3	6314 C3	25	-	-	-	23600	11800	5900	32200	16100	8050	
	250 MZ	2	6312 C3	6313 C3	25	13400	6700	3350	-	-	-	-	-	-	
	250 ME	4; 6	6216 C3	6314 C3	25	-	-	-	23600	11800	5900	32200	16100	8050	
	280 SC/MC	2							11800	5900	2950	-	-	-	-
	280 SC	6	6216 C3	6316 C3	35	-	-	-	-	-	-	32200	16100	8050	
	280 SD/MD	4; 6	6218 C3	6316 C3	35	-	-	-	20800	10400	5200	29600	14800	7400	
315 SN	2	6216 C3	6316 C3	35	5600	2800	1400	-	-	-	-	-	-		
315 MP	2	6317 C3	6317 C3	40	5200	2600	1300	-	-	-	-	-	-		
315 SP	4	6317 C3	6320 C3	50	-	-	-	15800	7900	3950	-	-	-		
315 MP/MR	4; 6												21200	10600	5300

* bearing with grease nipples on request

STANDARD BEARING FITTING ARRANGEMENTS

LS / LSES series		Horizontal shaft	Vertical shaft	
Foot mounted motors	Mounting arrangement	B3	Shaft facing down	Shaft facing up
		standard mounting	DE bearing: - located at DE for types ≤ 160MP/MR/LR - locked for types ≥ 160M/MU/L/LUR	V5
Flange mounted motors (or foot and flange)	Mounting arrangement	B5 / B35 / B14 / B34	V1 / V15 / V18 / V58	V3 / V36 / V19 / V69
	standard mounting	DE bearing locked	DE bearing locked	DE bearing locked

HORIZONTAL MOTOR

For a bearing life L_{10h}
of 25,000 hours
and 40,000 hours



Series	Type	No. of poles	Permissible axial load (in daN) on main shaft extension for standard bearing assembly													
			3000 min ⁻¹						1500 min ⁻¹				1000 min ⁻¹			
			→		←		→		←		→		←			
			25,000 hours	40,000 hours	25,000 hours	40,000 hours	25,000 hours	40,000 hours	25,000 hours	40,000 hours	25,000 hours	40,000 hours	25,000 hours	40,000 hours		
LS	56 M	2; 4; 6	7	5	28	24	14	10	35	30	17	12	38	32		
	63 M	2; 4; 6	13	9	34	29	18	13	39	33	26	18	47	40		
	71 M/L	2; 4; 6	13	9	34	29	18	13	39	33	26	18	47	40		
	80 L	2	30	21	(60)	(51)	-	-	-	-	-	-	-	-		
	80 LG	2; 4	28	19	(68)	(59)	48	34	(88)	(74)	-	-	-	-		
	90 SL/L	2; 4; 6	29	23	(69)	(56)	45	32	(85)	(72)	56	40	(96)	(80)		
	90 LU	2; 4; 6	22	13	(72)	(63)	38	25	(88)	(75)	47	32	(97)	(82)		
	100 L	2; 6	42	28	(92)	(78)	-	-	-	-	78	57	(128)	(107)		
	100 LR	4	-	-	-	-	58	39	(108)	(90)	-	-	-	-		
	100 LG	4; 6	-	-	-	-	55	38	(105)	(88)	75	53	(125)	(103)		
	112 M	2	38	25	(88)	(75)	-	-	-	-	-	-	-	-		
	112 MG	2; 6	37	24	(87)	(74)	-	-	-	-	126	104	(76)	(54)		
	112 MU	4; 6	-	-	-	-	54	36	(114)	(96)	66	45	(126)	(105)		
	132 S	2; 6	69	49	(129)	(109)	-	-	-	-	124	93	(184)	(153)		
	132 SU	2; 4	65	46	(125)	(106)	99	73	(159)	(133)	-	-	-	-		
	132 SM/M	2; 4; 6	101	74	(171)	(144)	148	111	(218)	(181)	178	134	(248)	(204)		
	132 MU	4; 6	-	-	-	-	139	103	(219)	(183)	168	124	(248)	(204)		
	160 MP	2	140	104	(220)	(184)	-	-	-	-	-	-	-	-		
	160 MR	2; 4	131	95	(221)	(185)	193	145	(283)	(235)	-	-	-	-		
160 M	2; 4; 6	132	96	232	196	187	140	287	240	235	179	335	279			
160 MU	6	-	-	-	-	-	-	-	-	219	164	319	264			
160 L	2; 4; 6	128	96	228	196	183	136	283	236	231	175	331	275			
160 LUR	4; 6	-	-	-	-	213	159	313	259	257	193	357	293			
180 M	4	-	-	-	-	228	174	291	237	-	-	-	-			
180 MR	2	156	115	256	215	-	-	-	-	-	-	-	-			
180 MT	2; 4	159	118	259	218	214	160	314	260	-	-	-	-			
180 L	6	-	-	-	-	-	-	-	-	265	201	328	264			
180 LR	4	-	-	-	-	203	150	303	250	-	-	-	-			
180 LUR	4; 6	-	-	-	-	224	170	287	233	224	162	287	225			
200 L	2; 6	244	190	310	256	-	-	-	-	362	278	428	344			
200 LR	2; 4; 6	244	191	307	254	312	241	375	304	341	258	404	321			
200 LU	4; 6	-	-	-	-	316	245	379	308	327	245	390	308			
225 SG	4	-	-	-	-	411	321	481	391	-	-	-	-			
225 SR	4	-	-	-	-	350	271	420	341	-	-	-	-			
225 ST	4	-	-	-	-	372	292	438	358	-	-	-	-			
225 MG	4; 6	-	-	-	-	407	317	477	387	535	426	605	496			
225 MR	2; 4; 6	280	220	343	283	358	278	421	341	409	315	472	378			
225 MT	2	281	221	347	287	-	-	-	-	-	-	-	-			
250 ME	4; 6	-	-	-	-	400	311	470	381	471	365	541	435			
250 MZ	2	277	217	340	280	-	-	-	-	-	-	-	-			
280 SC	2; 6	303	236	373	306	-	-	-	-	461	355	531	425			
280 SD	4	-	-	-	-	454	349	542	437	-	-	-	-			
280 MC	2	300	233	370	303	-	-	-	-	-	-	-	-			
280 MD	4; 6	-	-	-	-	446	342	534	430	524	401	612	489			
315 SN	2	357	279	427	349	-	-	-	-	-	-	-	-			
315 SP	4; 6	-	-	-	-	814	671	664	491	950	780	770	600			
315 MP	2; 4; 6	487	405	307	225	768	628	588	448	917	749	737	569			
315 MR	4; 6	-	-	-	-	770	630	590	450	864	699	684	519			

(): axial loads permissible with DE bearing locked

**VERTICAL MOTOR
SHAFT FACING DOWN**

For a bearing life L_{10h}
of 25,000 hours
and 40,000 hours



Series	Type	No. of poles	Permissible axial load (in daN) on main shaft extension for standard bearing assembly											
			3000 min ⁻¹				1500 min ⁻¹				1000 min ⁻¹			
			25,000 hours	40,000 hours	25,000 hours	40,000 hours	25,000 hours	40,000 hours	25,000 hours	40,000 hours	25,000 hours	40,000 hours	25,000 hours	40,000 hours
IM V5 IM V1 / V15 IM V18 / V58														
LS	56 M	2; 4; 6	6	4	24	20	13	9	36	30	16	11	39	33
	63 M	2; 4; 6	11	8	36	30	16	11	41	35	24	17	49	42
	71 M/L	2; 4; 6	11	8	36	30	16	11	41	35	24	17	49	42
	80 L	2	29	20	(63)	(54)	-	-	-	-	-	-	-	-
	80 LG	2; 4	26	16	(72)	(62)	45	32	(93)	(78)	-	-	-	-
	90 SL/L	2; 4; 6	26	16	(73)	(63)	42	28	(91)	(78)	53	37	(101)	(86)
	90 LU	2; 4; 6	19	9	(77)	(67)	33	20	(95)	(82)	43	28	(105)	(89)
	100 L	2; 6	38	24	(98)	(85)	-	-	-	-	73	52	(137)	(115)
	100 LR	4	-	-	-	-	52	34	(117)	(99)	-	-	-	-
	100 LG	4; 6	-	-	-	-	48	31	(116)	(99)	68	46	(137)	(115)
	112 M	2	35	21	(95)	(81)	-	-	-	-	-	-	-	-
	112 MG	2; 6	31	18	(98)	(85)	-	-	-	-	68	47	(138)	(116)
	112 MU	4; 6	-	-	-	-	45	28	(128)	(110)	57	36	(140)	(119)
	132 S	2; 6	61	41	(142)	(122)	-	-	-	-	115	84	(200)	(169)
	132 SU	2; 4	57	37	(139)	(120)	90	63	(176)	(149)	-	-	-	-
	132 SM/M	2; 4; 6	90	62	(189)	(161)	137	100	(237)	(200)	165	121	(270)	(226)
	132 MU	4; 6	-	-	-	-	125	89	(242)	(206)	152	108	(273)	(230)
	160 MP	2	126	90	(243)	(207)	-	-	-	-	-	-	-	-
	160 MR	2; 4	115	80	(246)	(210)	175	127	(311)	(264)	-	-	-	-
	160 M	2; 4; 6	111	75	264	229	164	117	326	278	210	154	375	319
160 MU	6	-	-	-	-	-	-	-	-	189	133	375	319	
160 L	2; 4; 6	106	70	263	228	160	113	322	274	208	151	371	314	
160 LUR	4; 6	-	-	-	-	186	131	363	309	227	162	417	352	
180 M	4	-	-	-	-	187	132	361	306	-	-	-	-	
180 MR	2	131	90	296	255	-	-	-	-	-	-	-	-	
180 MT	2; 4	136	95	295	254	189	134	360	305	-	-	-	-	
180 L	6	-	-	-	-	-	-	-	-	226	161	398	334	
180 LR	4	-	-	-	-	177	122	355	300	-	-	-	-	
180 LUR	4; 6	-	-	-	-	187	132	355	300	183	120	377	314	
200 L	2; 6	194	139	384	330	-	-	-	-	308	223	524	439	
200 LR	2; 4; 6	209	154	360	306	275	203	445	373	299	215	496	412	
200 LU	4; 6	-	-	-	-	262	190	471	398	269	186	505	422	
225 SG	4	-	-	-	-	335	244	616	524	-	-	-	-	
225 SR	4	-	-	-	-	294	213	520	439	-	-	-	-	
225 ST	4	-	-	-	-	322	241	519	438	-	-	-	-	
225 MG	4; 6	-	-	-	-	324	232	621	530	456	345	749	638	
225 MR	2; 4; 6	234	173	413	352	302	221	520	439	348	253	587	492	
225 MT	2	240	179	410	349	-	-	-	-	-	-	-	-	
250 ME	4; 6	-	-	-	-	305	214	632	541	378	270	712	604	
250 MZ	2	228	168	417	356	-	-	-	-	-	-	-	-	
280 SC	2; 6	233	165	488	420	-	-	-	-	348	240	728	621	
280 SD	4	-	-	-	-	340	233	738	632	-	-	-	-	
280 MC	2	221	153	496	428	-	-	-	-	-	-	-	-	
280 MD	4; 6	-	-	-	-	319	213	745	639	391	265	853	728	
315 SN	2	268	188	571	491	-	-	-	-	-	-	-	-	
315 SP	4; 6	-	-	-	-	620	475	923	778	748	575	1074	901	
315 MP	2; 4; 6	333	249	541	456	541	397	959	815	695	524	1088	917	
315 MR	4; 6	-	-	-	-	537	393	966	822	591	420	1151	981	

(): axial loads permissible with DE bearing locked

**VERTICAL MOTOR
SHAFT FACING UP**

For a bearing life L_{10h}
of 25,000 hours
and 40,000 hours

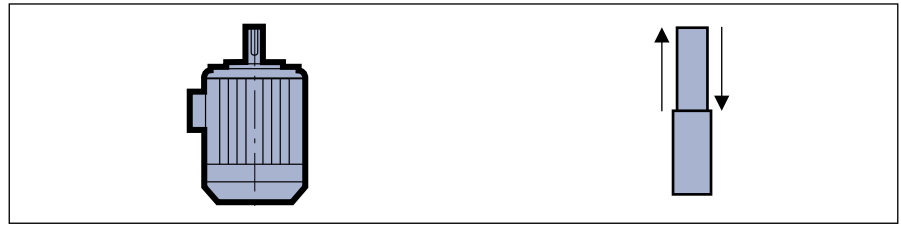

IP55 ALUMINIUM MOTORS

Series	Type	No. of poles	Permissible axial load (in daN) on main shaft extension for standard bearing assembly											
			3000 min ⁻¹				1500 min ⁻¹				1000 min ⁻¹			
			25,000 hours	40,000 hours	25,000 hours	40,000 hours	25,000 hours	40,000 hours	25,000 hours	40,000 hours	25,000 hours	40,000 hours	25,000 hours	40,000 hours
LS	56 M	2; 4; 6	8	5	27	23	15	10	34	29	18	13	39	33
	63 M	2; 4; 6	15	10	32	22	20	18	37	31	28	20	45	38
	71 M/L	2; 4; 6	15	10	32	22	20	18	37	31	28	20	45	38
	80 L	2	(59)	(50)	33	24	-	-	-	-	-	-	-	-
	80 LG	2; 4	(66)	(56)	32	22	(85)	(71)	53	39	-	-	-	-
	90 SL/L	2; 4; 6	(66)	(56)	33	23	(82)	(68)	51	38	(93)	(77)	61	46
	90 LU	2; 4; 6	(69)	(59)	27	18	(83)	(70)	45	32	(93)	(77)	54	39
	100 L	2; 6	(88)	(74)	48	35	-	-	-	-	(123)	(102)	87	65
	100 LR	4	-	-	-	-	(102)	(84)	67	49	-	-	-	-
	100 LG	4; 6	-	-	-	-	(98)	(81)	67	49	(118)	(96)	87	66
112 M	2	(84)	(71)	45	31	-	-	-	-	-	-	-	-	
112 MG	2; 6	(81)	(68)	48	35	-	-	-	-	(118)	(97)	88	66	
112 MU	4; 6	-	-	-	-	(105)	(88)	68	50	(117)	(96)	80	60	
132 S	2; 6	(121)	(101)	82	62	-	-	-	-	(175)	(143)	140	109	
132 SU	2; 4	(117)	(97)	79	60	(150)	(123)	116	89	-	-	-	-	
132 SM/M	2; 4; 6	(160)	(132)	119	91	(207)	(170)	167	130	(235)	(191)	200	156	
132 MU	4; 6	-	-	-	-	(206)	(169)	163	126	(232)	(188)	193	150	
160 MP	2	(206)	(170)	163	127	-	-	-	-	-	-	-	-	
160 MR	2; 4	(205)	(170)	156	120	(265)	(217)	222	174	-	-	-	-	
160 M	2; 4; 6	211	175	164	129	264	217	226	178	310	254	275	219	
160 MU	6	-	-	-	-	-	-	-	-	289	233	275	219	
160 L	2; 4; 6	206	170	163	128	260	213	222	174	308	251	271	214	
160 LUR	4; 6	-	-	-	-	286	231	263	209	327	262	317	252	
180 M	4	-	-	-	-	250	195	298	243	-	-	-	-	
180 MR	2	231	190	196	155	-	-	-	-	-	-	-	-	
180 MT	2; 4	236	195	195	154	289	234	260	205	-	-	-	-	
180 L	6	-	-	-	-	-	-	-	-	289	224	335	271	
180 LR	4	-	-	-	-	277	222	255	200	-	-	-	-	
180 LUR	4; 6	-	-	-	-	250	195	292	237	246	183	314	251	
200 L	2; 6	260	205	318	264	-	-	-	-	374	289	458	373	
200 LR	2; 4; 6	272	217	297	243	338	266	382	310	362	278	433	349	
200 LU	4; 6	-	-	-	-	325	253	408	335	332	249	442	359	
225 SG	4	-	-	-	-	405	314	546	454	-	-	-	-	
225 SR	4	-	-	-	-	364	283	450	369	-	-	-	-	
225 ST	4	-	-	-	-	388	307	453	372	-	-	-	-	
225 MG	4; 6	-	-	-	-	394	302	551	460	526	415	679	568	
225 MR	2; 4; 6	297	236	350	289	365	284	457	376	411	316	524	429	
225 MT	2	306	245	344	283	-	-	-	-	-	-	-	-	
250 ME	4; 6	-	-	-	-	375	284	562	471	448	340	642	534	
250 MZ	2	291	231	354	293	-	-	-	-	-	-	-	-	
280 SC	2; 6	303	235	418	350	-	-	-	-	418	310	658	551	
280 SD	4	-	-	-	-	428	321	650	544	-	-	-	-	
280 MC	2	291	223	426	358	-	-	-	-	-	-	-	-	
280 MD	4; 6	-	-	-	-	407	301	657	551	479	353	765	640	
315 SN	2	338	258	501	421	-	-	-	-	-	-	-	-	
315 SP	4; 6	-	-	-	-	440	295	1103	958	568	395	1254	1081	
315 MP	2; 4; 6	153	69	721	636	361	217	1139	995	515	344	1268	1097	
315 MR	4; 6	-	-	-	-	357	213	1146	1002	411	240	1331	1161	

(): axial loads permissible with DE bearing locked

STANDARD FITTING ARRANGEMENT

Permissible radial load on main shaft extension with a bearing life L_{10h} of 25,000 hours.

FR: Radial Force

X: Distance with respect to the shaft shoulder

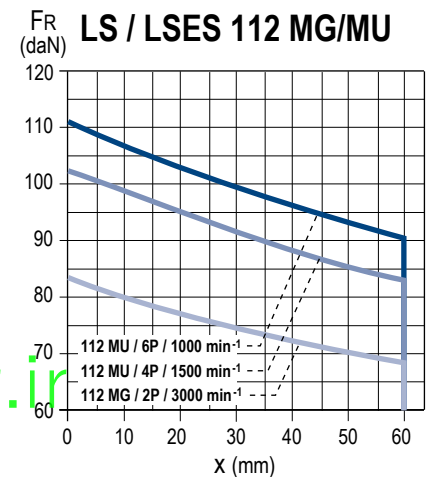
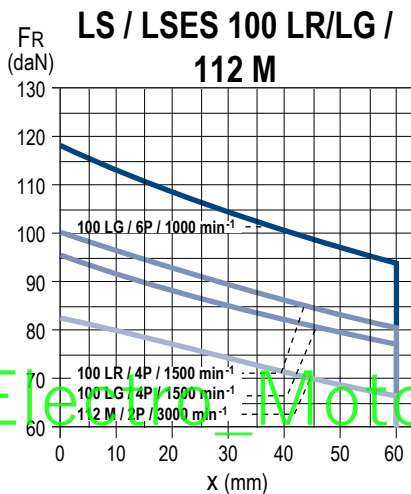
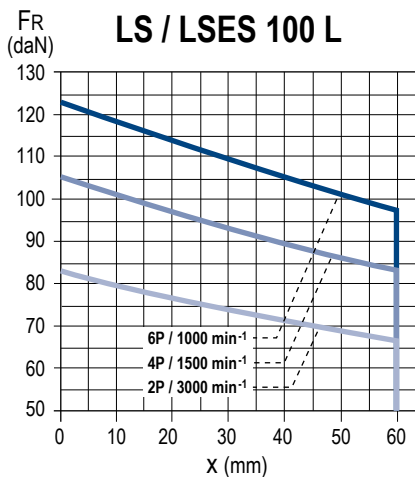
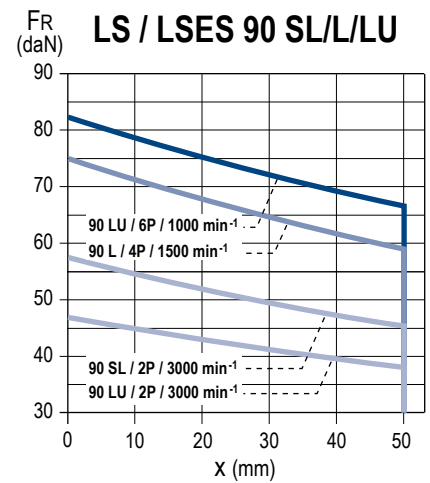
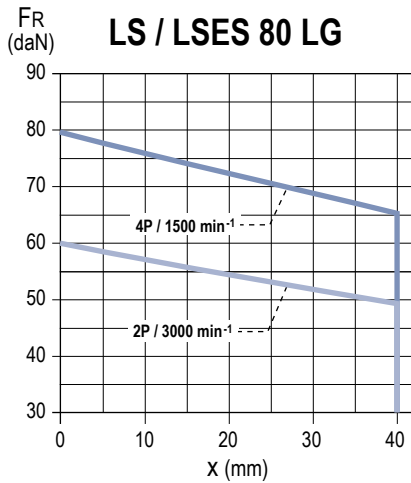
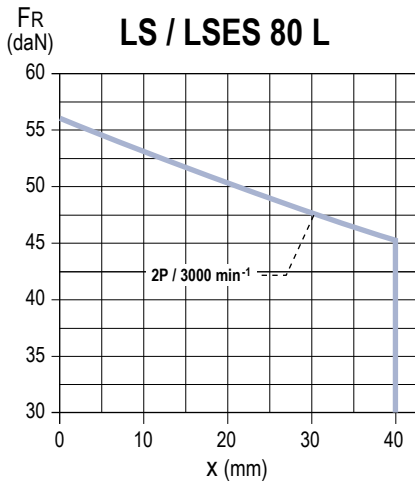
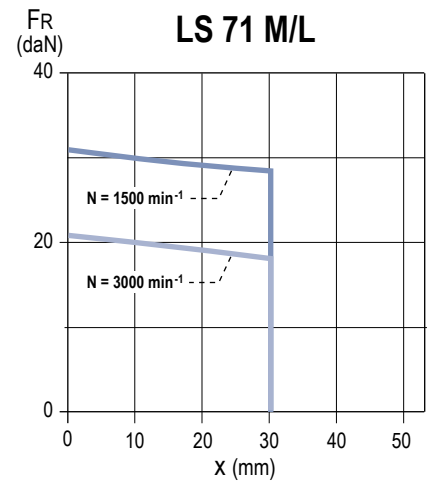
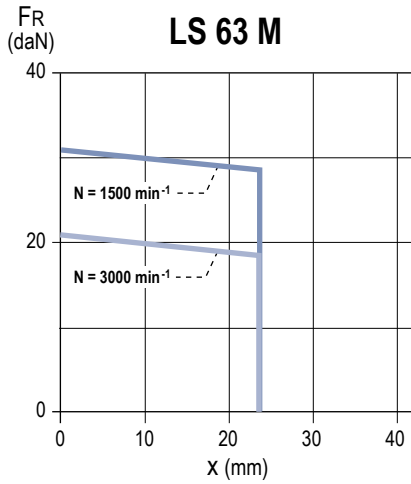
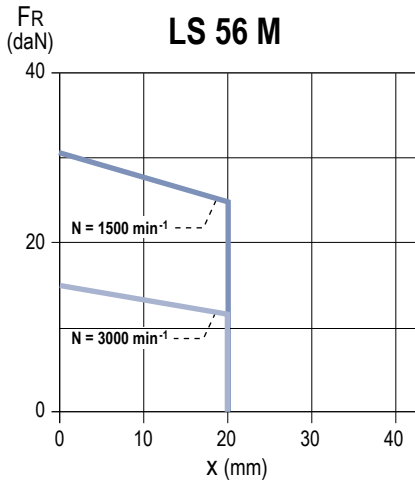

Electro_Motor.ir

STANDARD FITTING ARRANGEMENT

Permissible radial load on main shaft extension with a bearing life L_{10h} of 25,000 hours.

FR: Radial Force

X: Distance with respect to the shaft shoulder

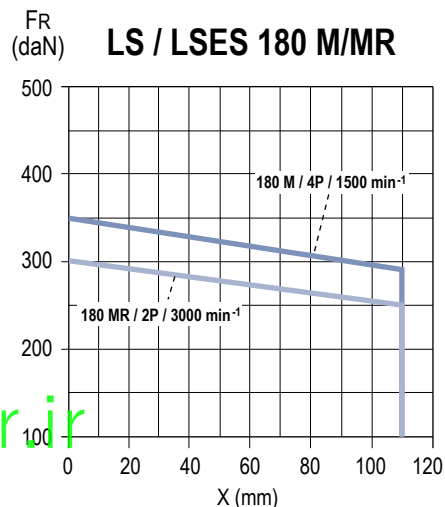
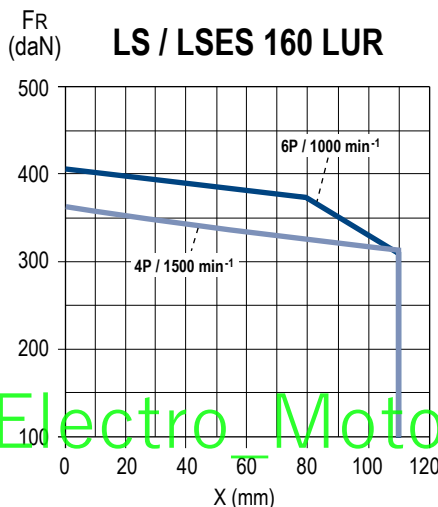
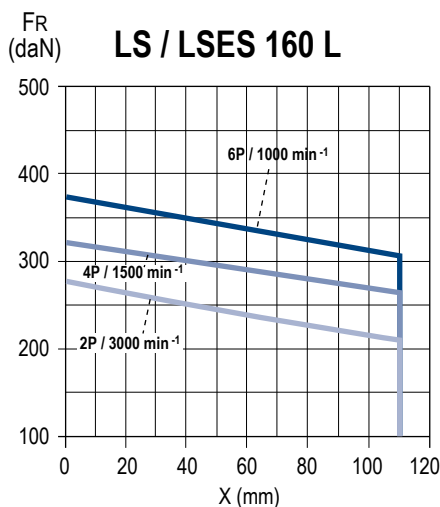
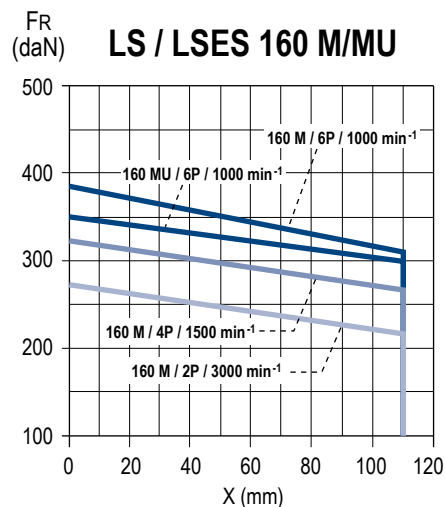
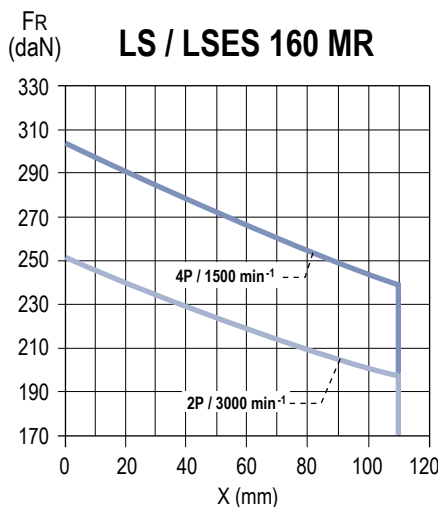
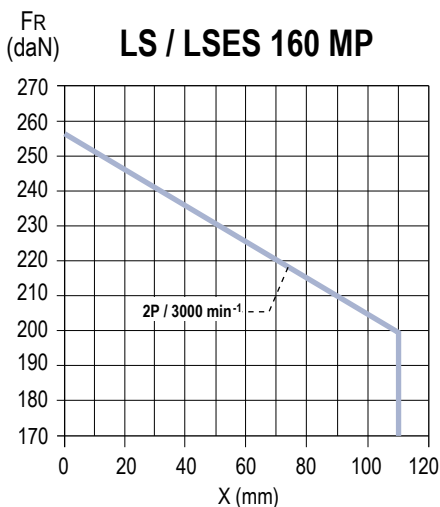
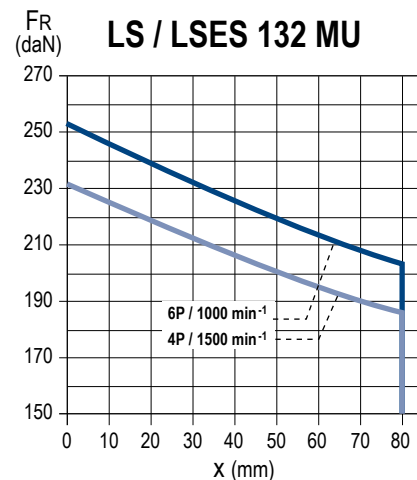
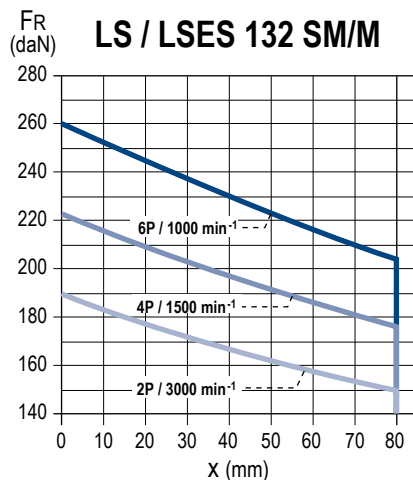
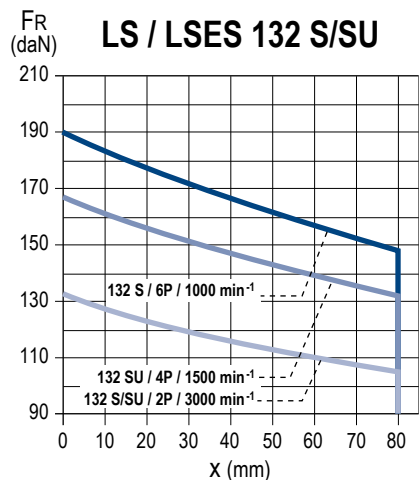

STANDARD FITTING ARRANGEMENT

Permissible radial load on main shaft extension with a bearing life L_{10h} of 25,000 hours.

FR : Radial Force

X: Distance with respect to the shaft shoulder

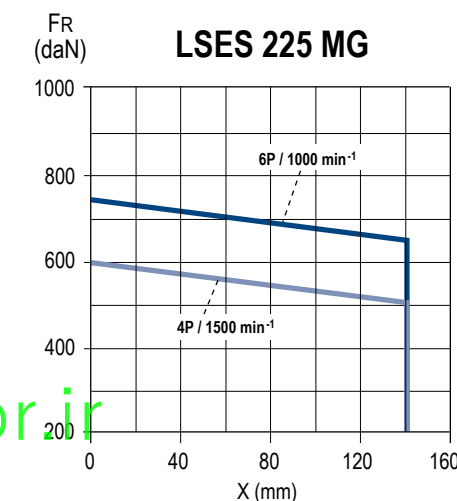
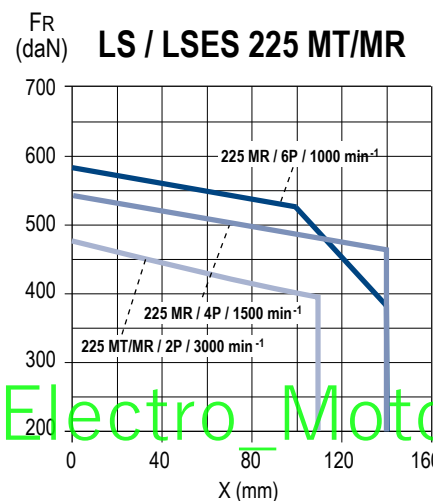
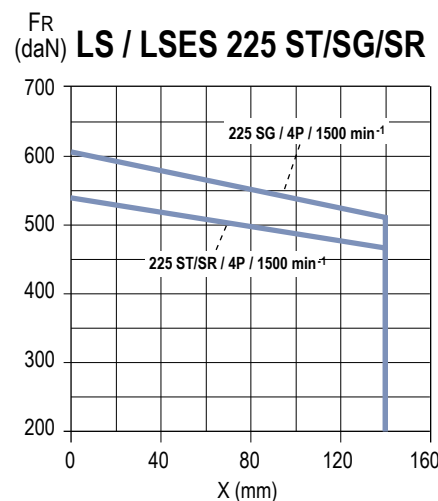
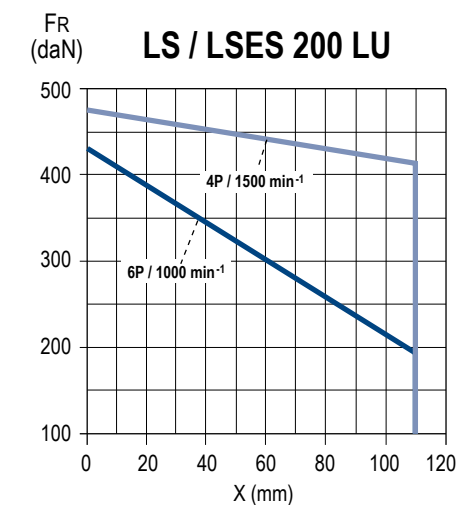
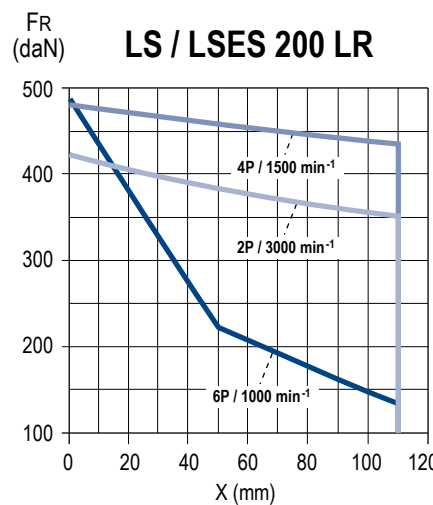
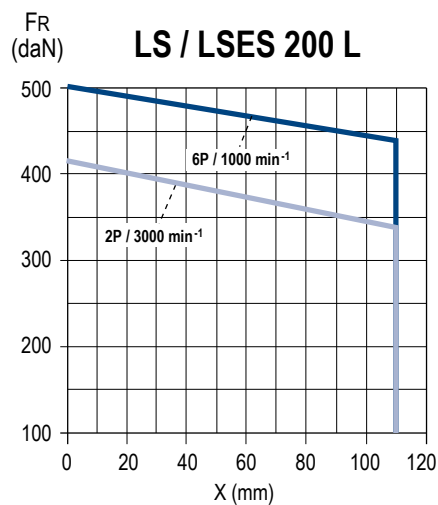
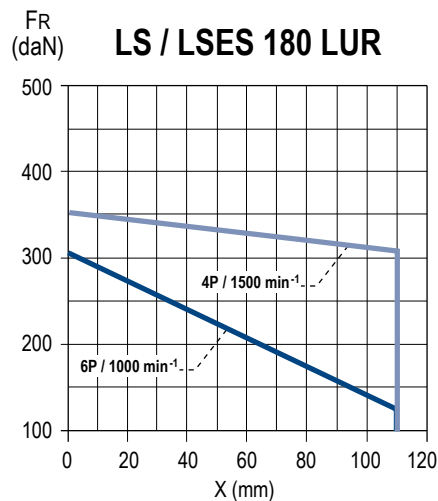
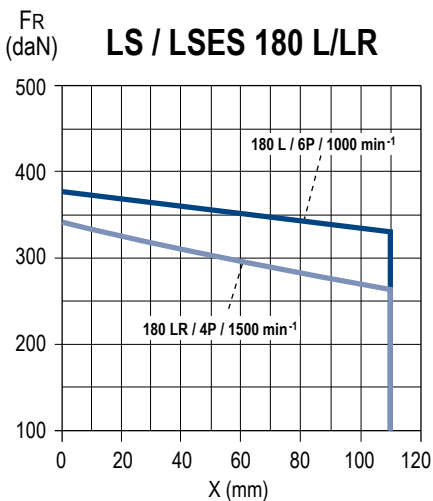
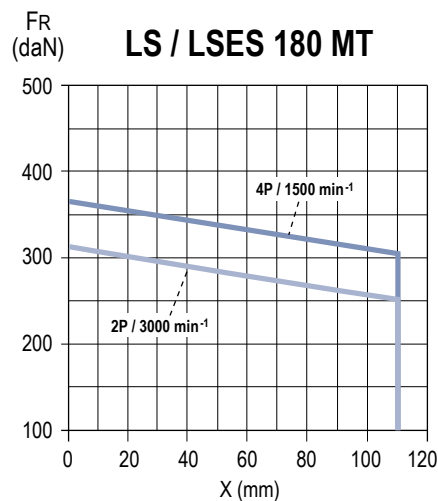

Electro_Motor.ir

STANDARD FITTING ARRANGEMENT

Permissible radial load on main shaft extension with a bearing life L_{10h} of 25,000 hours.

FR : Radial Force

X: Distance with respect to the shaft shoulder

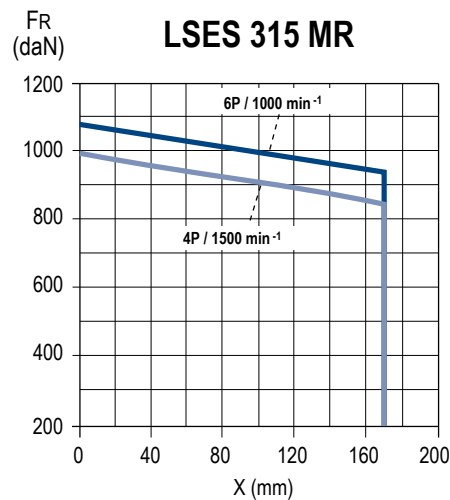
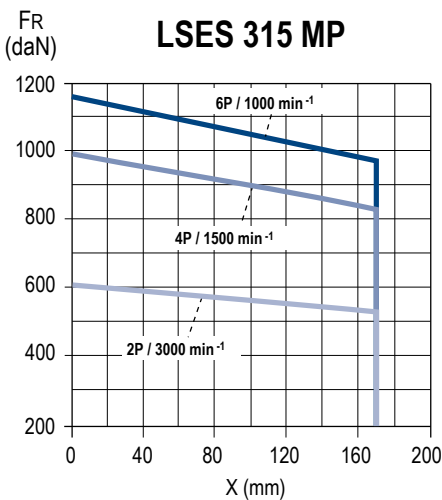
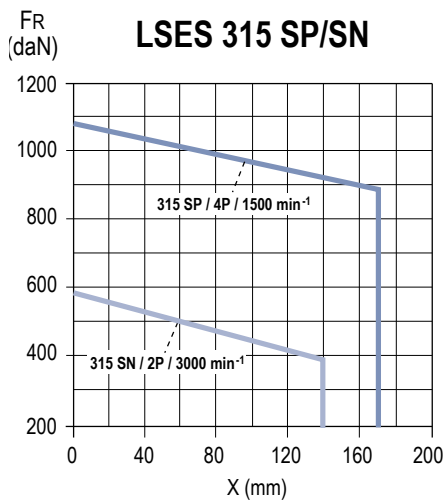
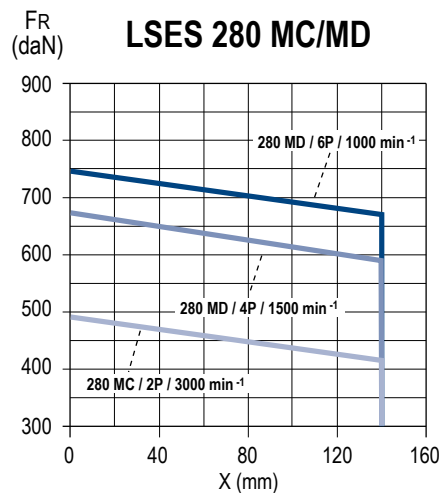
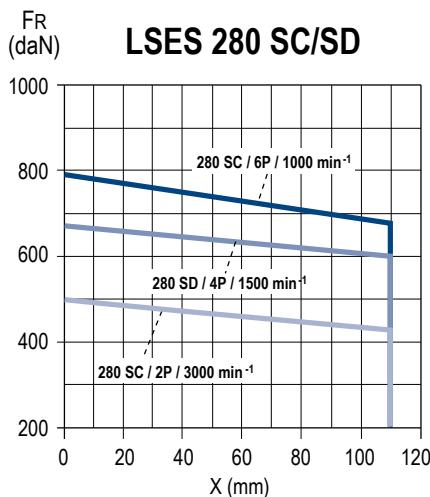
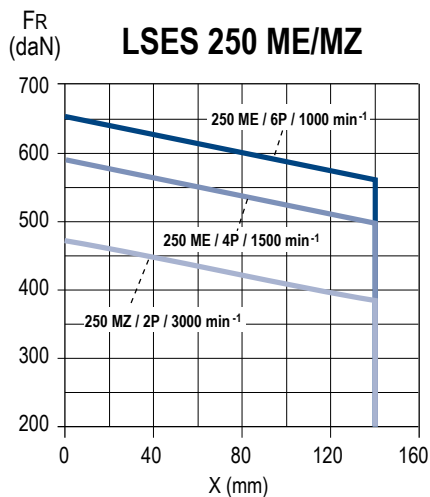

SPECIAL FITTING ARRANGEMENT

Type of drive end roller bearings

Series	Type	No. of poles	Non drive end bearing (N.D.E.)	Drive end bearing (D.E.)
LS / LSES	160 M/MU	4 ; 6	6210 C3	NU 309
	160 L			
	180 MT	4	6210 C3	NU 310
	180 LR			
	180 LUR	4 ; 6	6312 C3	NU 310
	180 M	4	6212 C3	NU 310
	180 L	6		
	200 L	6	6214 C3	NU 312
	200 LR	4 ; 6	6312 C3	NU 312
	200 LU			
	225 ST	4	6214 C3	NU 313
	225 SR/MR	4 ; 6	6312 C3	NU 313
	225 SG	4	6216 C3	NU 314
	225 MG	4 ; 6		
	250 ME	4 ; 6	6216 C3	NU 314
	280 SC	6	6216 C3	NU 316
	280 SD/MD	4 ; 6	6218 C3	NU 316
315 SP	4	6317 C3	NU 320	
315 MP/MR	4 ; 6			

SPECIAL FITTING ARRANGEMENT

Permissible radial load on main shaft extension with a bearing life L_{10h} of 25,000 hours.

FR : Radial Force

X: Distance with respect to the shaft shoulder

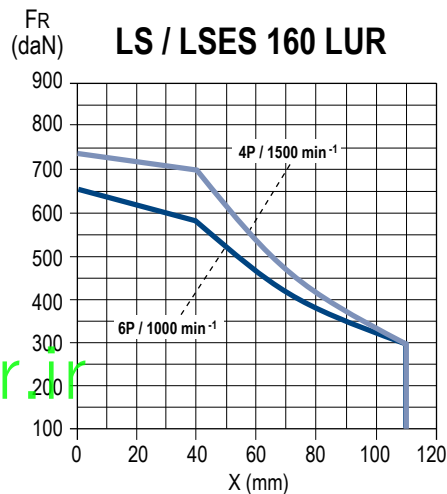
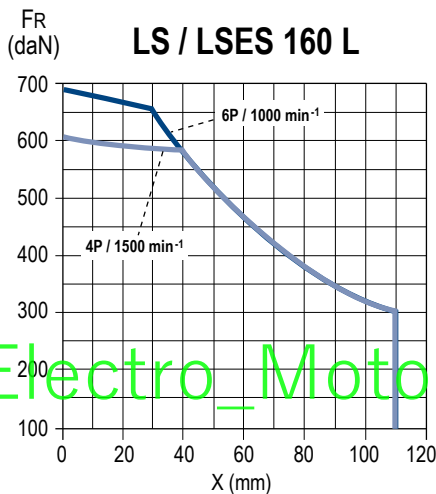
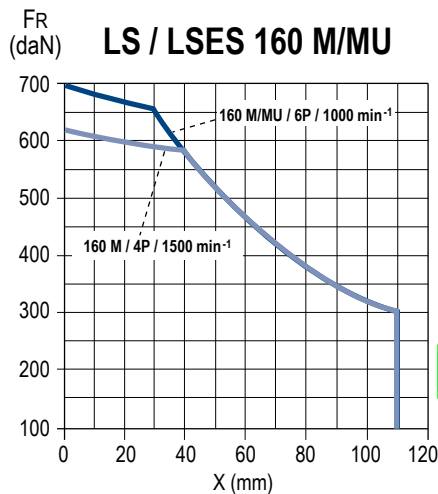

SPECIAL FITTING ARRANGEMENT

Permissible radial load on main shaft extension with a bearing life L_{10h} of 25,000 hours.

FR : Radial Force

X: Distance with respect to the shaft shoulder

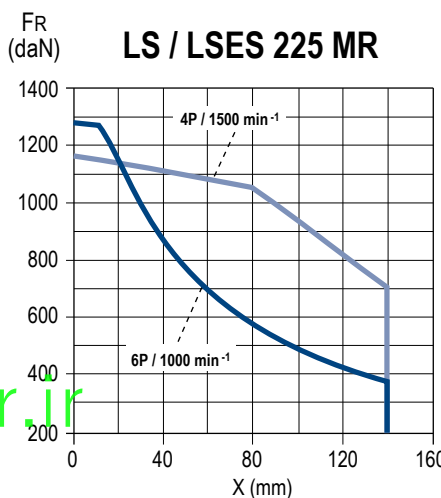
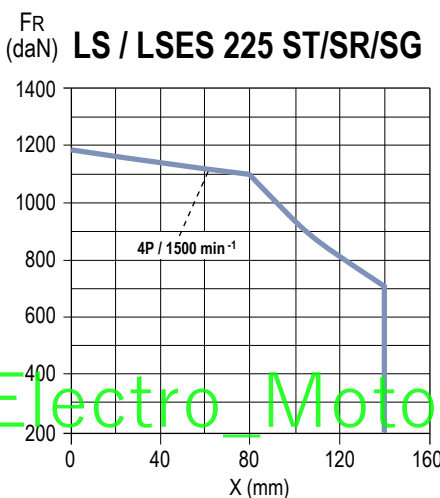
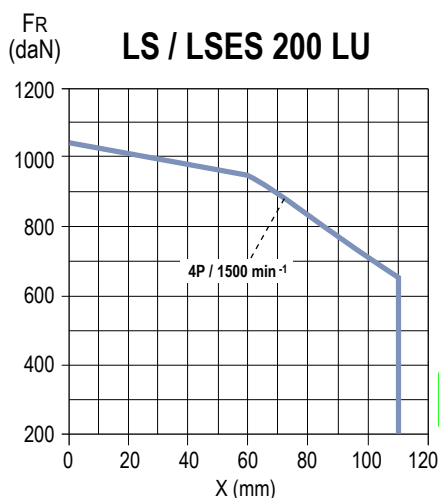
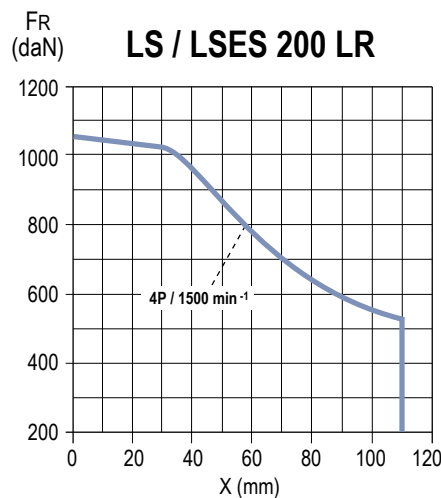
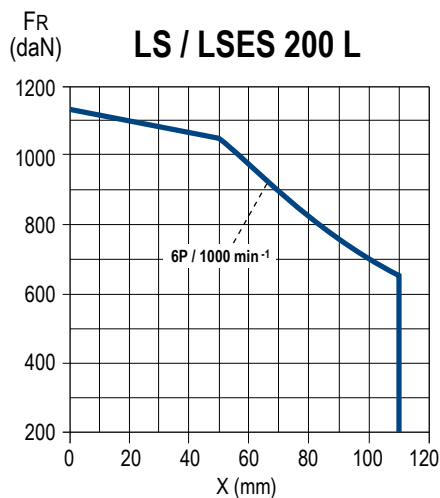
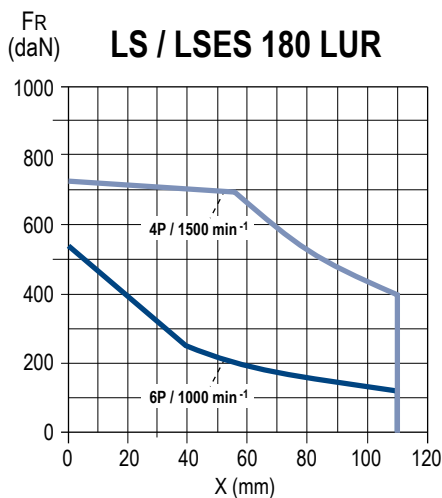
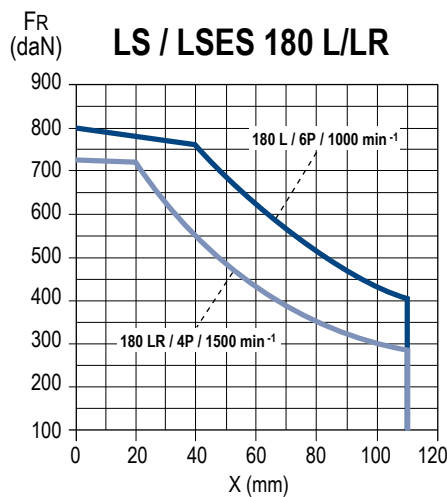
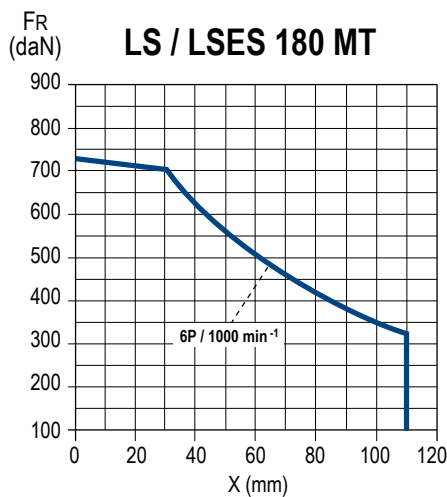
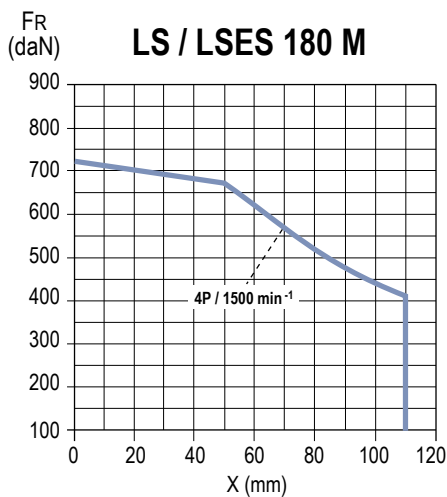

Electro_Motor.ir

SPECIAL FITTING ARRANGEMENT

Permissible radial load on main shaft extension with a bearing life L_{10h} of 25,000 hours.

FR : Radial Force

X: Distance with respect to the shaft shoulder

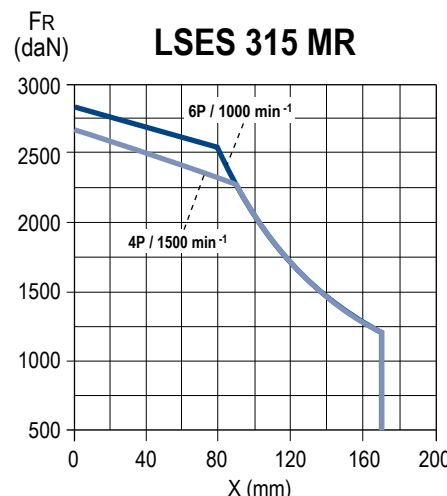
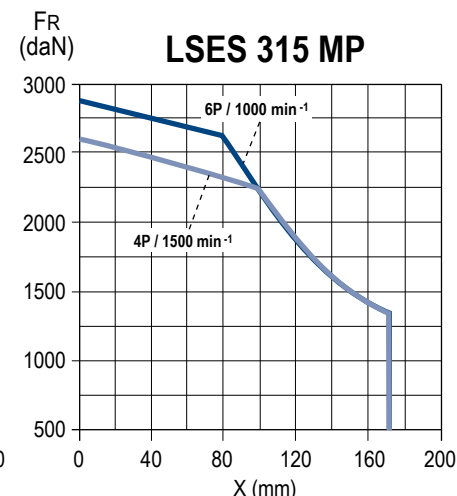
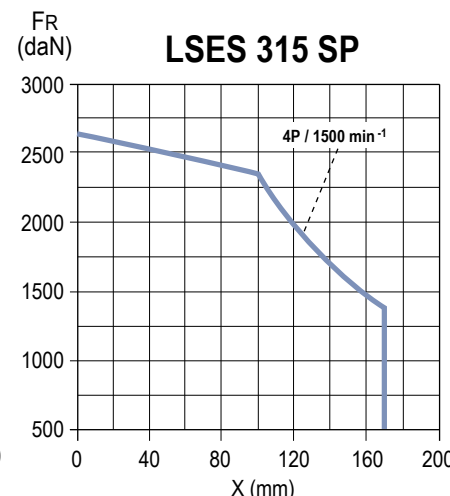
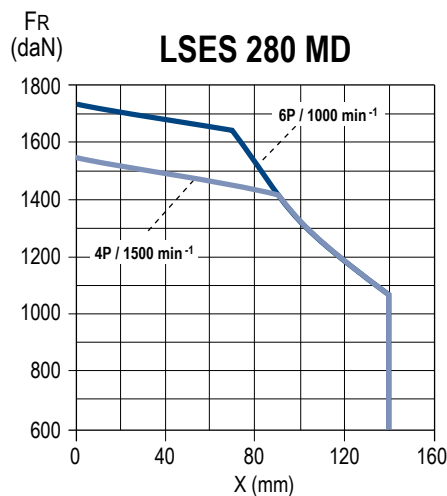
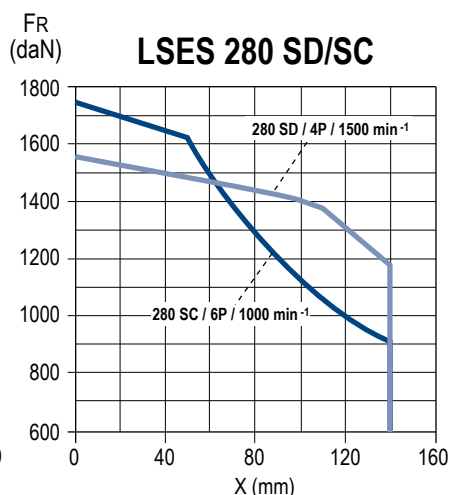
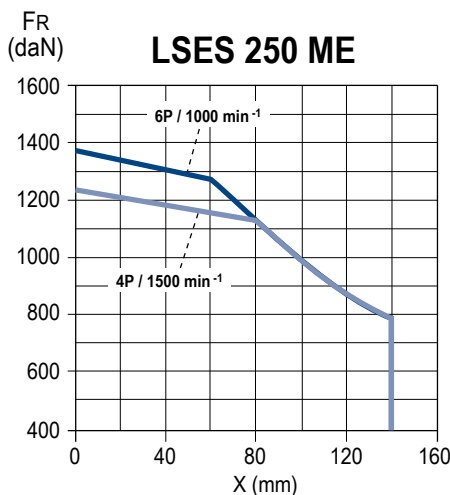
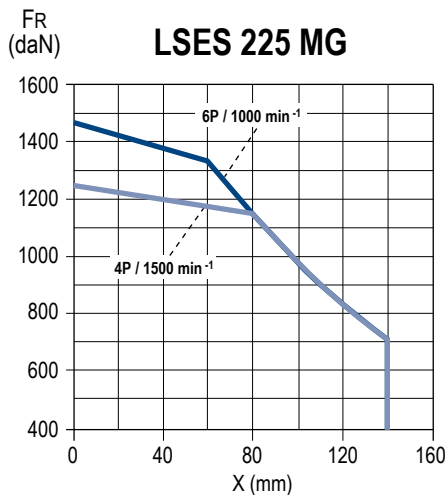

Electro_Motor.ir

Optionally, Nidec Leroy-Somer motors can be fitted with flanges and faceplates that are larger or smaller than standard. This means that motors can be adapted to all types of situation without the need for costly and time-consuming modifications.

The tables below give the flange and faceplate dimensions and also indicate flange/motor compatibility.

The bearing and shaft extension for each frame size remain standard.

Dimensions in millimetres

(FF) Flange mounted

IEC symbol	Flange dimensions						
	M	N	P	T	n	S	LA
FF 100	100	80	120	2.5	4	7	5
FF 115	115	95	140	3	4	10	10
FF 130	130	110	160	3.5	4	10	10
FF 165	165	130	200	3.5	4	12	10
FF 215	215	180	250	4	4	15	12
FF 265	265	230	300	4	4	15	14
FF 300	300	250	350	5	4	18.5	14
FF 350	350	300	400	5	4	18.5	15
FF 400	400	350	450	5	8	18.5	16
FF 500	500	450	550	5	8	18.5	18
FF 600*	600	550	660	6	8	24	22

* Tolerance N js6

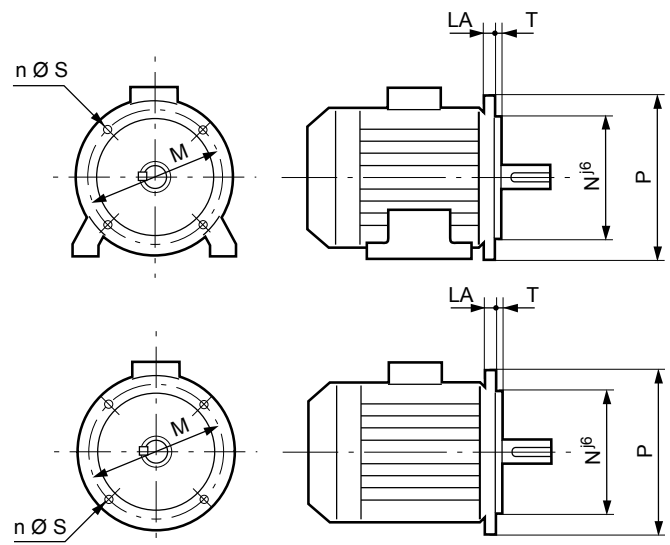

(FT) Face mounted

IEC symbol	Faceplate dimensions					
	M	N	P	T	n	M.S
FT 65	65	50	80	2.5	4	M5
FT 75	75	60	90	2.5	4	M5
FT 85	85	70	105	2.5	4	M6
FT 100	100	80	120	3	4	M6
FT 115	115	95	140	3	4	M8
FT 130	130	110	160	3.5	4	M8
FT 165	165	130	200	3.5	4	M10
FT 215	215	180	250	4	4	M12
FT 265	265	230	300	4	4	M12

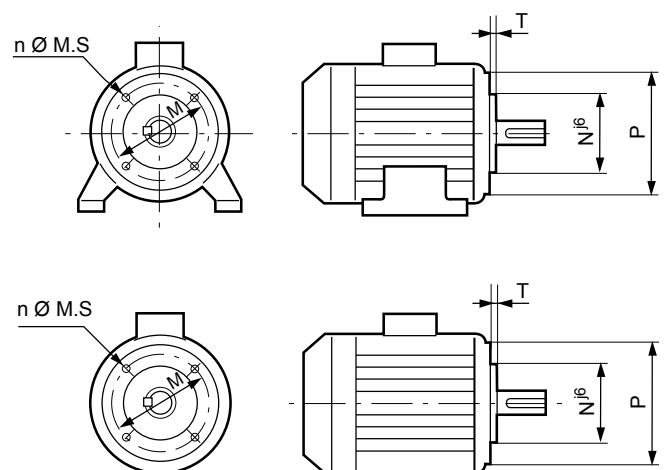

MODIFIED FLANGES

Motor type	Flange type Mounting forms	(FF) Flange mounted											(FT) Face mounted										
		FF 85	FF 100	FF 115	FF 130	FF 165	FF 215	FF 265	FF 300	FF 350	FF 400	FF 500	FF 600	FT 65	FT 75	FT 85	FT 100	FT 115	FT 130	FT 165	FT 215	FT 265	
56 M	all		●										●	◆	◆	●							
63 M	all	■	■	●	◆								◆	●	◆	◆	◆						
71 M/L	all	■	■	■	●	◆							◆	◆	●	◆	◆	◆					
80 L	all	■	■	■	■	●	◆						◆	◆	◆	●	◆	◆	◆				
80 LG	B5/B35 ⁽¹⁾	◆	◆	◆	◆	●	◆	■															
80 LG	B3/B14/B34	■	■	■	■	■	■	■							◆	●	◆	◆	◆	◆	■		
90 SL/L/LU	B5/B35 ⁽¹⁾	◆	◆	◆	◆	●	◆	■															
90 SL/L/LU	B3/B14/B34	■	■	■	■	■	■	■							◆	◆	●	◆	◆	◆	■		
100 L/LR	all	■	■	■	■	■	●	■							◆	◆	◆	◆	●	◆	◆	◆	
100 LG	all				■	■	●	◆									◆	●	◆	◆	◆	◆	
112 M/MR	all	■	■	■	■	■	●	■							◆	◆	◆	◆	●	◆	◆	◆	
112 MG/MU	all				■	■	●	◆									◆	●	◆	◆	◆	◆	
132 S/SU	all					■	◆	●										◆	●	◆	◆	◆	
132 SM/M/MU	all				■	■	●	◆	◆									■	●	◆	◆	■	
160 MR/LR/MP	all						◆	■	●	■											●		
160 M/MU/L/LUR	all							◆	●	◆													
180	all							◆	●	◆	◆ ⁽¹⁾												
200	all							◆	●	◆													
225	all								●	◆													
250	all									◆	●												
280	all									◆	●	◆											
315	all										●												

● Standard ■ Adapted shaft ◆ Adaptable without shaft modifications ⁽¹⁾ Dimension C need not comply with IEC 60072

DRIP COVER FOR OPERATION IN VERTICAL POSITION, SHAFT END FACING DOWN

Dimensions in millimetres

Motor type	LB'	Ø
80	LB + 20	145
90	LB + 20	185
100	LB + 20	185
112 MR	LB + 20	185
112 MG/MU	LB + 25	210
132 S/SU	LB + 25	210
132 M/MU	LB + 30	240
160 MP/LR	LB + 30	240
160 M/L/LU	LB + 36.5	265
180 MT/LR	LB + 36.5	265
180 L	LB + 36.5	305
200 LR	LB + 36.5	305
200 L	LB + 36.5	350
225	LB + 36.5	350
250 MZ	LB + 36.5	350
250 ME	LB + 55	420
280	LB + 55	420
315 SN	LB + 55	420
315 SP/MP/MR	LB + 76.5	505

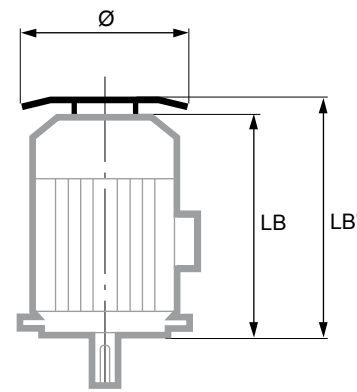

Electro_Motor.ir

BRAKE MOTORS, FORCED VENTILATION

The integration of high-efficiency motors within a process often requires accessories to make operation easier:

- Forced ventilation for motors used at high or low speeds.
- Holding brakes for maintaining the rotor in the stop position without needing to leave the motor switched on.
- Emergency stop brakes to immobilise loads in case of failure of the motor torque control or loss of power supply.

Notes:

- Without forced ventilation, there is a possibility of overspeed with optional class B balancing.
- The motor temperature is monitored by sensors built into the windings.

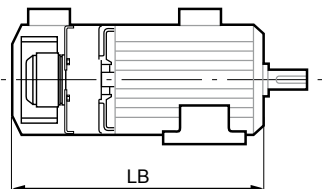

LSES series	LB dimensions with Forced Ventilation	
	Foot or face mounted motors	Flange mounted motor
80 L	317	
80 LG	331	351
90 S	304	324
90 L	331	351
100 L	373	
100 LR	373	
112 MR	412	
112 MG	412	
112 MU	412	
132 S	453	
132 SU	453	
132 M	458	
132 MU	458	
160 MP	709	
160 MR	730	
160 L	730	
160 M	687	
180 MT	702	
180 LR	702	
180 L	741	
200 LR	796	
200 L	802	
225 MR	853.5	
225 ST	808.5	
225 MT	808.5	
250 ME	1012	
250 MZ	853.5	
280 MD	1072	
280 SC	1012	
280 MC	1012	
315 SN	1072	
315 SP	1181	
315 MP	1181	
315 MR	1251	

MOTORS WITH SPACE HEATERS

Type	Power (W)
80 L	16
80 LG to 160 MP/LR	25
160 M/L to 225 ST/MT/MR	52
250 MZ	52
250 ME/MF	84
280 SC/MC/MD	84
315 SN	108
315 MP/MR	108

The space heaters use 200/240 V single-phase, 50 or 60 Hz.

INTEGRATED VARIABLE SPEED MOTORS: COMMANDER ID300

The Commander ID300 is the association of a 3-phase induction motor of IMfinity® range and an integrated high performance variable speed drive.

It can be used with a large panel of options for motor and drive, that allows the product to perfectly suit application needs.

Commander ID300 operates on all mains supplies (200 Volts to 480 Volts 50/60 Hz).

The variable speed drive offers a decentralised solution on the machine, the product being designed to operate in industrial conditions (resin-encapsulated electronics).

Commander ID300 complies with the European EC marking standards and North American standards, UL for the USA and c(UL)us for Canada.



Electro_Motor.ir

IMfinity® 3-phase induction motors - IE2 - IE3 - IE4 - Non IE Efficiency

IP55 Aluminium frame

Installation and maintenance

Position of the lifting rings

LIFTING THE MOTOR ONLY (not coupled to the machine)

The regulations stipulate that over 25 kg, suitable handling equipment must be used.

All our motors are fitted with grab handles, making them easier to handle without risk. A diagram of the sling hoisting method appears below with the required dimensions.

To prevent any damage to the motor during handling (for example: switching the motor from horizontal to vertical), it is essential to follow these instructions.

HORIZONTAL POSITION

Dimensions in millimetres

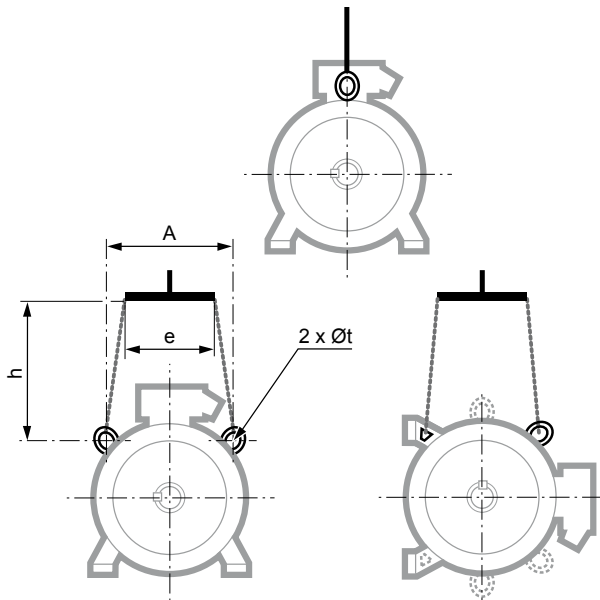

LS / LSES Series	Horizontal position			
	A	e min	h min	Øt
100 L/LR/LG	165	165	150	9
112 M/MR	165	165	150	9
112 MG/MU	-	-	-	9
132 S/SU	180	180	150	9
132 M/MU	200	180	150	14
160 MP/MR/LR	200	180	110	14
160 M/MU/L/LUR	200	260	150	14
180 M/MUR/L/LUR	200	260	150	14
200 L/LR	270	260	150	14
200 LU	270	260	150	14
225 SR/MR	270	260	150	14
225 S/SG/M/MG	360	380	200	30
250 MZ	360	380	200	30
250 ME	400	400	500	30
280 SC/SD/MC/MD	400	400	500	30
315 SN	400	400	500	30
315 SP/MP/MR	360	380	500	17

VERTICAL POSITION

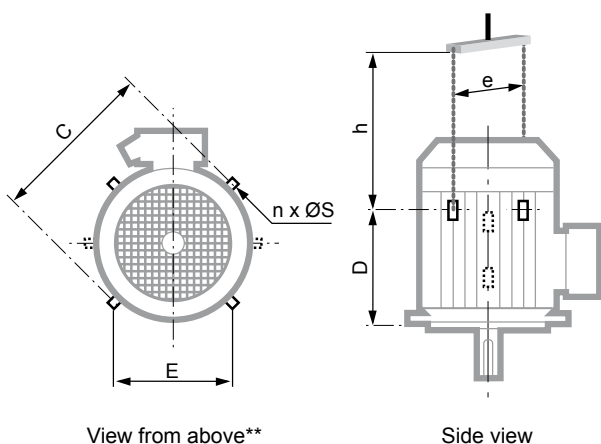

LS / LSES Series	Vertical position						
	C	E	D	n**	ØS	e min*	h min
160 M/MU/L/LUR	320	200	230	2	14	320	350
180 MR	320	200	230	2	14	320	270
180 M/L/LUR	390	265	290	2	14	390	320
200 L/LR	410	300	295	2	14	410	450
200 LU	410	300	295	2	14	410	450
225 SR/MR	480	360	405	4	30	540	350
225 S/SG/M/MG	480	360	405	4	30	500	500
250 MZ	480	360	405	4	30	590	550
250 ME	480	360	405	4	30	500	500
280 SC/SD/MC/MD	480	360	405	4	30	500	500
315 SN	480	360	405	4	30	500	500
315 SP/MP/MR	630	-	570	2	30	630	550

* if the motor is fitted with a drip cover, allow an additional 50 to 100 mm to avoid damaging it when the load is swung.

** if n = 2, the lifting rings form a 90° angle with respect to the terminal box axis.

If n = 4, this angle becomes 45°.

Separate ring ≤ 25 kg

Built-in ring > 25 kg

Electro_Motor.ir



IP 55
Cl. F - ΔT 80 K

The complete motor **reference** described below will enable you to **order** the desired equipment.

The selection method consists of following the terms in the designation.

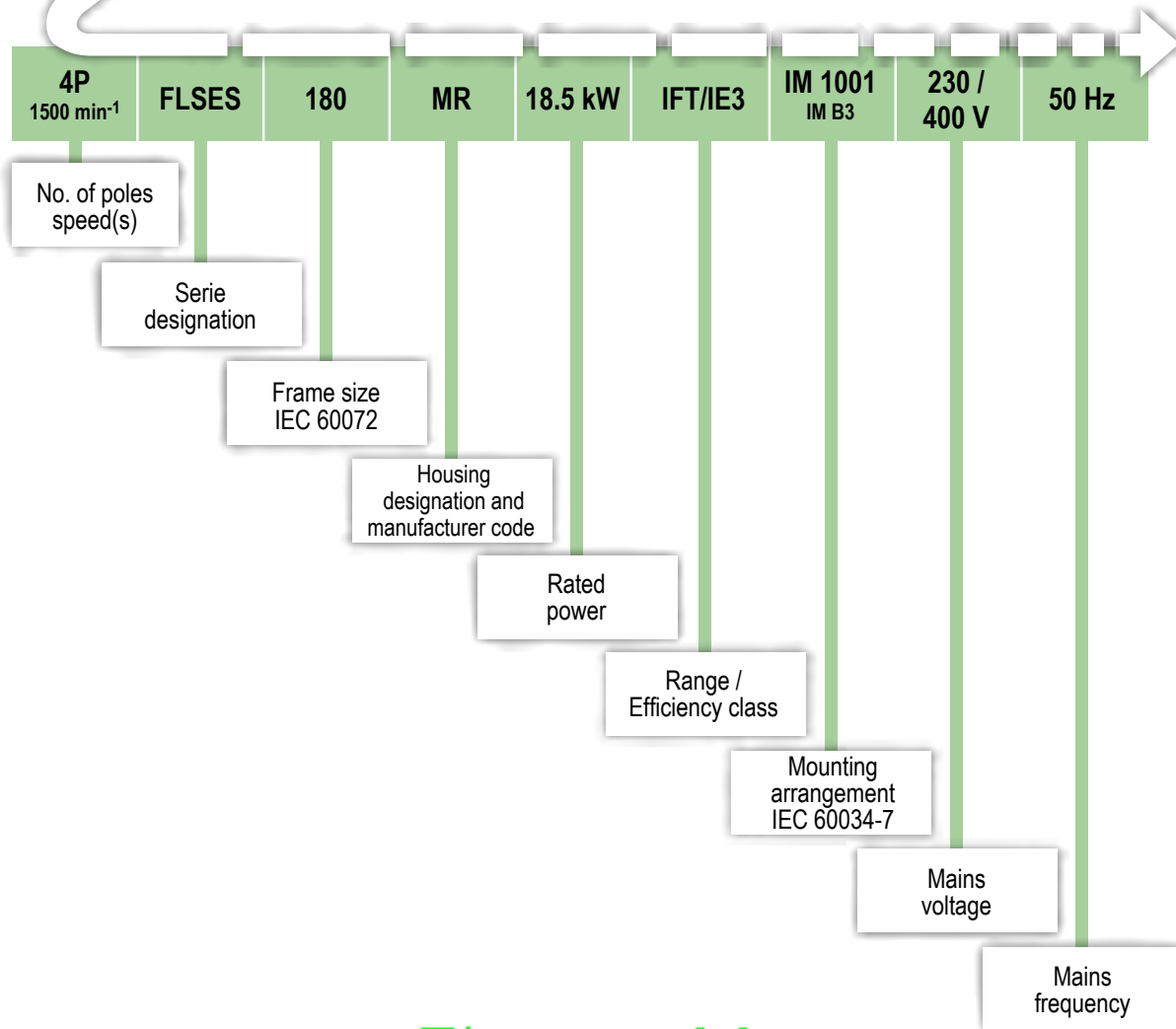

IP55 CAST IRON MOTORS

Electro_Motor.ir

IMfinity® 3-phase induction motors - IE2 - IE3 - IE4 - Non IE Efficiency

IP55 Cast iron frame

General information

Description

Component	Materials	Remarks
Housing with cooling fins	Cast iron	- lifting rings for frame size ≥ 90 - earth terminal with an optional jumper screw
Stator	Insulated low-carbon magnetic steel laminations Electroplated copper	- low carbon content guarantees long-term lamination pack stability - welded laminations - semi-enclosed slots - class F insulation
Rotor	Insulated low-carbon magnetic steel laminations Aluminium	- inclined cage bars - rotor cage pressure die-cast in aluminium (or alloy for special applications). or soldered in copper, or keyed for soldered rotors - shrink-fitted to shaft - rotor balanced dynamically, class A, 1/2 key
Shaft	Steel	- for frame size ≤ 132 : • closed keyway - for frame size ≤ 160 : • tapped hole - for frame size ≥ 160 : • open keyway
End shields	Cast iron	
Bearings and lubrication		- permanently greased bearings frame size 80 to 225 - regreasable bearings frame size 250 to 450 - bearings preloaded at NDE up to 315 S, preloaded at DE from size 315 M upwards
Labyrinth seal Lipseals	Plastic or steel Synthetic rubber	- labyrinth seal at drive end for foot mounted motors, frame size ≤ 132 - lipseal at drive end for foot and flange mounted or flange mounted motors, frame size ≤ 132 - lipseal at drive end and non drive end for frame sizes 160 to 250 inclusive - decompression grooves for 280 M to 355 LD - labyrinth seal at drive end and non drive end for frame sizes ≥ 355 LK
Fan	Composite up to size 280 inclusive Metal from 315 ST upwards	- 2 directions of rotation: straight blades
Fan cover	Pressed steel	- fitted. on request, with a drip cover for operation in vertical position, shaft end facing down
Terminal box	Cast iron body and cover for all frame sizes except frames 355 LK, 400 & 450 where it can be steel	- IP 55 - fitted with a block with 6 terminals up to 355 LD, 6 or 12 terminals for frame sizes 355LK/400/450 - terminal box fitted with threaded plugs up to 132 - from the 160 to the 355, undrilled cable gland mounting plate (nozzle and cable gland as options) - 1 earth terminal in each terminal box

In the standard version. the motors are wound 400 V 50 Hz:

- power ratings ≤ 5.5 kW: Y connection; 230 / 400 V

- power ratings ≥ 7.5 kW: Δ connection; 400 / 690 V

Other construction types

CORROBLOC FINISH

The CORROBLOC finish is a top coat for the basic cast iron motor described above. In addition to the basic construction. Its special finishes resist corrosion in particularly harsh environments, and these qualities are enhanced with age.

Component	Materials	Remarks
Stator - Rotor		- dielectric and anti-corrosion protection for frame sizes 80 to 132
Nameplate	Stainless steel	- nameplate: indelible marking
Screws	Stainless steel	- captive screws for terminal box cover (frame size ≤ 132)
Terminal box	Cast iron body and cover or steel	- terminal box with brass buttons for frame size ≤ 132
Cable gland	Brass	- option
External finish		- system IIIa (see External finish section) = C4M

IMfinity® 3-phase induction motors - IE2 - IE3 - IE4 - Non IE Efficiency

IP55 Cast iron frame

Electrical and mechanical characteristics

IE2 - Powered by the mains

Type	Rated power P kW	Rated torque M _n N.m	Starting torque/ Rated torque M _d /M _n	Maximum torque/ Rated torque M _m /M _n	Starting current/ Rated current I _d /I _n	Moment of inertia J kg.m ²	Weight IMB3 kg	Noise LP db(A)	400V / 50Hz														
									Rated speed n _n min ⁻¹	Rated current I _n A	Efficiency IEC 60034-2-1 2014			Power factor Cos φ									
											4/4	3/4	2/4	4/4	3/4	2/4							
2 poles																							
FLSES 80L	0.75	2.5	2.65	3.15	6.3	0.00084	15.9	59	2845	1.6	79.80	80.80	79.30	0.86	0.79	0.67							
FLSES 80L	1.1	3.7	2.65	3.05	6.4	0.00095	16.2	60	2850	2.3	80.90	82.30	81.60	0.85	0.78	0.65							
FLSES 90SL	1.5	5	2.55	2.7	6.25	0.00201	22.8	67	2860	3	85.90	85.90	85.80	0.86	0.81	0.71							
FLSES 90L	2.2	7.3	2.62	2.82	6.26	0.00223	23.9	67	2875	4.5	83.50	85.40	85.60	0.83	0.76	0.63							
FLSES 100L	3	9.9	4.4	3.94	7.69	0.00297	31.9	67	2890	6.1	85.10	84.80	84.00	0.83	0.76	0.63							
FLSES 112MG	4	13.1	1.9	3.05	7.35	0.00822	42.2	66	2925	7.6	88.30	89.00	88.10	0.86	0.81	0.70							
FLSES 132SM	5.5	18	1.8	2.65	5.85	0.00898	66.6	66	2925	10.3	89.90	90.90	90.70	0.86	0.83	0.74							
FLSES 132SM	7.5	24.4	1.8	2.51	5.77	0.00974	69.4	67	2930	14.1	90.30	91.10	90.90	0.85	0.80	0.70							
FLSES 132M	9	29.3	1.9	2.81	6.5	0.01102	74.4	67	2935	16.8	90.90	91.70	91.40	0.85	0.80	0.71							
FLSES 160M	11	35.6	2.8	3.15	7.83	0.049	112	68	2950	20.1	90.70	91.20	90.80	0.87	0.83	0.75							
FLSES 160M	15	48.6	2.95	2.8	6.95	0.049	120	69	2945	26.7	91.20	92.00	92.10	0.89	0.87	0.81							
FLSES 160L	18.5	60.2	2.6	2.95	7.7	0.0551	129	69	2935	32.7	91.50	92.50	92.90	0.89	0.87	0.81							
FLSES 180M	22	71.5	2.95	3.05	7.95	0.1333	162	68	2940	39.3	92.00	93.00	93.20	0.88	0.86	0.79							
FLSES 200LU	30	97.1	2.1	3.05	7.2	0.2035	210	71	2950	53.9	92.60	93.00	92.70	0.87	0.84	0.77							
FLSES 200LU	37	120	2.05	3.35	6.9	0.1388	230	75	2945	65.2	93.00	93.60	93.50	0.88	0.86	0.80							
FLSES 225MR	45	145	2.57	3.42	7.9	0.1597	254	71	2956	81.9	94.30	94.60	94.30	0.84	0.80	0.70							
FLSES 250M	55	177	2.1	3.2	7.7	0.3356	378	79	2968	95.8	94.00	94.10	93.20	0.88	0.85	0.79							
FLSES 280S	75	241	2.07	2.73	6.9	0.48	565	79	2966	127	93.80	94.10	94.00	0.91	0.89	0.85							
FLSES 280M	90	290	2.18	2.78	7.3	0.57	615	80	2967	153	94.10	94.40	94.30	0.90	0.89	0.85							
FLSES 315S	110	353	2.07	2.57	6.5	1.45	940	80	2975	187	94.30	94.30	94.00	0.90	0.89	0.84							
FLSES 315M	132	424	2.07	2.5	6.65	1.25	1015	80	2975	223	94.60	94.60	94.30	0.90	0.89	0.84							
FLSES 315LA	160	514	2.1	2.83	6.5	1.34	1088	80	2975	274	94.80	94.80	94.50	0.89	0.87	0.83							
FLSES 315LB	200	642	2.1	2.86	6.82	1.45	1150	80	2973	337	95.00	95.00	94.70	0.90	0.88	0.84							
FLSES 355LA	250	802	2.2	2.85	6.83	3.02	1590	82	2978	428	95.00	95.00	94.70	0.88	0.86	0.80							
FLSES 355LB	315	1008	2.55	3	7.72	3.62	1740	82	2983	544	95.00	95.00	94.70	0.88	0.86	0.82							
FLSES 355LC	355	1137	2.8	2.67	6.88	3.64	1770	82	2981	620	95.00	95.00	94.70	0.87	0.85	0.81							
FLSES 355LD	400	1282	1.88	2.58	6.87	3.7	1800	82	2989	683	95.00	95.00	94.70	0.89	0.87	0.81							
FLSES 355LKB	450	1439	2.2	5.26	12.5	6.4	2550	93	2991	760	95.00	94.50	93.50	0.90	0.87	0.80							
FLSES 400LB	560	1789	1.2	5.64	9.7	7.4	2640	93	2988	920	95.00	94.51	93.34	0.93	0.91	0.87							
4 poles																							
FLSES 80LG	0.75	4.95	2	2.9	5.7	0.00265	20	45	1445	1.7	80.90	81.70	80.10	0.79	0.71	0.57							
FLSES 90SL	1.1	7.3	1.95	2.75	5.8	0.00336	22.3	51	1440	2.4	81.80	83.30	82.40	0.81	0.74	0.60							
FLSES 90L	1.5	10	2.39	2.94	6.8	0.00418	24.6	49	1440	3.15	83.10	84.50	84.00	0.82	0.74	0.61							
FLSES 100L	2.2	14.5	2.55	3.15	6.65	0.00567	33.2	50	1445	4.55	85.10	86.20	85.80	0.82	0.75	0.62							
FLSES 100LG	3	19.7	2.31	2.81	6.76	0.00997	38.5	50	1452	6	86.90	87.70	88.10	0.83	0.77	0.66							
FLSES 112MU	4	26.3	2	2.8	6.2	0.01312	46.6	50	1450	7.9	87.00	88.30	88.10	0.84	0.80	0.70							
FLSES 132SM	5.5	36	2.5	3.2	7.4	0.01925	66.3	60	1458	10.7	88.60	89.70	89.50	0.83	0.77	0.65							
FLSES 132M	7.5	49.3	2.5	3.05	7.15	0.02286	71	60	1454	14.4	89.10	90.30	90.50	0.85	0.79	0.68							
FLSES 132M	9	59.1	2.8	3.35	7.75	0.02722	78	61	1454	17.5	89.70	90.70	90.60	0.83	0.77	0.65							
FLSES 160M	11	71.6	2.3	2.7	7.74	0.0601	114	55	1468	20.8	91.10	92.00	92.00	0.84	0.79	0.68							
FLSES 160L	15	98	2.5	3.35	7.78	0.0551	115	59	1462	28	91.00	92.00	92.10	0.85	0.79	0.68							
FLSES 180MT	18.5	121	2.65	3.3	8	0.0844	135	58	1464	34.7	91.20	92.00	92.00	0.84	0.79	0.67							
FLSES 180L	22	143	3	2.95	7.6	0.1333	170	70	1466	41	92.30	93.10	93.10	0.84	0.80	0.70							
FLSES 200LU	30	195	2.6	2.15	6.26	0.2035	250	66	1472	56.7	92.30	93.20	93.20	0.83	0.79	0.69							
FLSES 225SR	37	240	2.7	2.65	6.55	0.2467	275	66	1470	69.5	93.00	93.70	93.80	0.83	0.79	0.69							
FLSES 225M	45	289	2.11	2.71	6.64	0.6482	380	65	1486	84.7	93.50	93.90	93.80	0.82	0.77	0.67							
FLSES 250MR	55	354	2.05	2.45	6.85	0.7701	440	67	1482	102	94.00	94.40	94.30	0.83	0.79	0.70							
FLSES 280S	75	482	2.31	2.84	7.6	0.85	600	70	1484	137	94.00	94.20	93.90	0.84	0.80	0.71							
FLSES 280M	90	579	2.69	2.67	8	0.98	645	75	1483	164	94.20	94.40	94.10	0.84	0.82	0.72							
FLSES 315S	110	707	2.07	2.66	6.9	2.02	940	75	1486	200	94.50	94.70	94.30	0.84	0.81	0.73							
FLSES 315M	132	848	2.77	2.76	6.68	2.09	985	75	1487	237	94.70	94.90	94.50	0.85	0.82	0.76							
FLSES 315LA	160	1030	2.3	2.55	6.28	2.72	1055	75	1484	286	94.90	95.10	94.70	0.85	0.85	0.78							
FLSES 315LB	200	1285	2.75	3.0	7.1	2.86	1245	75	1486	357	95.10	95.30	94.90	0.85	0.81	0.72							
FLSES 355LA	250	1604	2.55	3.1	7.45	4.9	1445	80	1488	441	95.10	95.30	94.90	0.86	0.82	0.71							
FLSES 355LAL	280	1798	2.4	2.94	7.4	5.8	1560	80	1487	488	95.10	95.30	94.90	0.87	0.85	0.78							
FLSES 355LB	315	2020	2.46	2.9	7.5	6.56	1720	80	1488	550	95.10	95.30	94.90	0.87	0.84	0.76							
FLSES 355LC	355	2280	2.36	2.74	7.47	6.56	1740	82	1487	612	95.10	95.30	94.90	0.88	0.86	0.80							
FLSES 355LD	400	2577	1.68	2.72	7.73	6.6	1750	82	1488	690	95.10	95.30	94.90	0.88	0.87	0.83							
FLSES 355LKB	450	2880	1.47	3.47	8.3	11.5	2530	82	1490	789	95.10	95.07	94.67	0.87	0.83	0.74							
FLSES 400LB	500	3217	1.32	3.1	7.54	11.5	2630	82	1490	869	95.10	95.27	94.99	0.87	0.85	0.77							
FLSES 450LA	550	3520	1.48	2.19	6.7	23.7	3100	84	1492	950	95.10	95.50	95.00	0.88	0.87	0.82							
FLSES 450LB	675	4323	1.67	2.74	6.9	26.55	3775	84	1491	1192	95.10	95.60	95.30	0.86	0.85	0.80							
FLSES 450LD	800	5117	2.1	2.9	8.5	34.8	4400	84	1493	1397	95.10	95.60	95.20	0.87	0.85	0.77							
FLSES 450LD	900	5761	1.9	2.58	7.6	34.8	4400	84	1492	1571	95.10	95.50	95.00	0.87	0.85	0.77							
6 poles																							
FLSES 90SL	0.75	7.6	2	2.3	4.2	0.00338	23.1	44	945	2	78.20	78.90	76.50	0.70	0.61	0.48							
FLSES 90L	1.1	11.2	1.9	2.4	4.3	0.00437	26.1	42	940	2.85	79.10	80.50	79.20	0.71									

IMfinity® 3-phase induction motors - IE2 - IE3 - IE4 - Non IE Efficiency

IP55 Cast iron frame

Electrical and mechanical characteristics

IE2 - Powered by the mains

Type	Rated power at 50Hz P _n kW	380V / 50Hz				415V / 50Hz				460V / 60Hz				
		Rated speed	Rated current	Efficiency	Power factor	Rated speed	Rated current	Efficiency	Power factor	Rated speed	Rated torque at 60Hz	Rated current	Efficiency	Power factor
		N _n min ⁻¹	I _n A	η 4/4	Cos φ 4/4	N _n min ⁻¹	I _n A	η 4/4	Cos φ 4/4	N _n min ⁻¹	M _{N_m}	I _n A	η 4/4	Cos φ 4/4
2 poles														
FLSES 80L	0.75	2815	1.65	78.60	0.88	2860	1.55	80.20	0.84	3470	2.06	1.4	81.70	0.83
FLSES 80L	1.1	2825	2.4	80.10	0.87	2865	2.3	82.20	0.82	3480	3	2.05	83.40	0.82
FLSES 90SL	1.5	2840	3.15	82.90	0.88	2875	2.9	84.90	0.85	3490	4.1	2.6	85.90	0.85
FLSES 90L	2.2	2855	4.65	84.30	0.85	2885	4.5	85.10	0.83	3505	6	4	87.00	0.80
FLSES 100L	3	2865	6.25	84.60	0.86	2900	6.05	85.00	0.81	3485	8.2	5.15	86.80	0.84
FLSES 112MG	4	2910	7.85	87.80	0.88	2930	7.50	88.50	0.84	3535	10.8	6.6	89.60	0.85
FLSES 132SM	5.5	2910	10.8	88.70	0.87	2930	10	90.20	0.85	3540	14.8	8.9	90.70	0.85
FLSES 132SM	7.5	2920	15	88.10	0.86	2940	14	90.60	0.83	3550	20.2	12.3	91.40	0.84
FLSES 132M	9	2925	17.5	90.30	0.87	2940	16.6	91.10	0.83	3550	24.2	14.6	92.00	0.84
FLSES 160M	11	2940	21.1	89.90	0.88	2954	19.7	91.10	0.85	3554	29.6	17.5	91.20	0.86
FLSES 160M	15	2930	28.1	90.30	0.90	2950	25.6	92.30	0.88	3554	40.3	22.7	92.80	0.89
FLSES 160L	18.5	2935	34.7	90.90	0.90	2945	31.6	92.50	0.88	3550	49.8	28.1	93.00	0.89
FLSES 180M	22	2925	41	91.30	0.89	2945	37.7	92.30	0.88	3554	59.1	33.8	93.00	0.88
FLSES 200LU	30	2945	56.2	92.00	0.88	2954	51.8	93.90	0.86	3554	80.6	46.2	94.00	0.87
FLSES 200LU	37	2935	68.5	92.50	0.89	2950	62.9	94.20	0.87	3552	99.5	56.1	94.10	0.88
FLSES 225MR	45	2950	84.2	94.30	0.86	2960	80.7	94.40	0.82	3564	121	70.6	95.10	0.84
FLSES 250M	55	2966	99.7	93.70	0.89	2972	87.5	94.40	0.87	3574	147	83.2	94.30	0.88
FLSES 280S	75	2962	133	93.80	0.91	2958	123	93.90	0.90	3566	201	111	93.60	0.91
FLSES 280M	90	2961	160	94.10	0.91	2971	148	94.20	0.90	3567	241	131	94.50	0.91
FLSES 315S	110	2974	197	94.30	0.90	2978	182	94.40	0.89	3576	294	164	94.50	0.89
FLSES 315M	132	2974	236	94.60	0.90	2978	218	94.60	0.89	3576	352	196	95.00	0.89
FLSES 315LA	160	2973	285	94.80	0.90	2977	264	94.90	0.89	3575	427	237	95.20	0.89
FLSES 315LB	200	2973	355	95.00	0.90	2977	329	95.10	0.89	3575	534	296	95.40	0.89
FLSES 355LA	250	2976	449	95.00	0.89	2982	416	95.10	0.88	3578	667	374	95.40	0.88
FLSES 355LB	315	2981	566	95.00	0.89	2985	524	95.10	0.88	3583	840	471	95.40	0.88
FLSES 355LC	355	2979	645	95.00	0.88	2983	597	95.10	0.87	3581	947	537	95.40	0.87
FLSES 355LD	400	2987	710	95.00	0.90	2991	657	95.10	0.89	3589	1064	591	95.40	0.89
FLSES 355LKB	450	2990	792	94.90	0.91	2991	736	95.10	0.90	3592	1196	658	95.40	0.90
FLSES 400LB	560	2987	965	94.90	0.93	2990	891	95.10	0.92	3590	1490	799	95.40	0.92
4 poles														
FLSES 80LG	0.75	1435	1.75	80.30	0.82	1450	1.7	81.00	0.76	1756	4.1	1.5	83.60	0.75
FLSES 90SL	1.1	1430	2.45	81.40	0.84	1445	2.35	82.20	0.79	1752	6	2.1	84.60	0.78
FLSES 90L	1.5	1430	3.25	82.80	0.84	1445	3.15	83.50	0.80	1756	8.2	2.8	85.60	0.79
FLSES 100L	2.2	1435	4.65	84.30	0.85	1450	4.45	85.40	0.80	-	-	-	-	-
FLSES 100LG	3	1445	6.15	86.10	0.86	1456	5.8	87.20	0.82	1762	16.3	5.2	89.00	0.82
FLSES 112MU	4	1440	8.2	86.60	0.86	1454	7.6	88.10	0.83	1760	21.7	7.05	89.40	0.80
FLSES 132SM	5.5	1450	11	87.90	0.86	1460	10.6	88.90	0.81	1764	29.8	9.45	90.50	0.81
FLSES 132M	7.5	1445	14.7	88.70	0.87	1458	14.2	89.50	0.82	1762	40.6	12.5	90.90	0.83
FLSES 132M	9	1450	17.8	89.20	0.86	1458	17.3	89.90	0.81	1764	48.7	15.2	91.30	0.82
FLSES 160M	11	1464	21.4	90.50	0.86	1472	20.5	91.30	0.82	1772	59.3	18	92.20	0.83
FLSES 160L	15	1458	29.1	90.60	0.87	1468	27.9	91.20	0.82	1770	80.9	24.5	92.40	0.83
FLSES 180MT	18.5	1460	36.3	91.20	0.85	1468	34.5	91.30	0.82	1770	99.8	30.2	92.70	0.83
FLSES 180L	22	1462	42.4	91.80	0.86	1470	40	92.50	0.83	1772	119	35.6	93.40	0.83
FLSES 200LU	30	1466	58.4	92.30	0.85	1476	55.5	92.80	0.81	1780	161	48.8	93.80	0.82
FLSES 225SR	37	1466	71.4	92.70	0.85	1474	68	93.40	0.81	1776	199	60.1	94.20	0.82
FLSES 225M	45	1484	87.7	93.10	0.85	1486	83.2	93.60	0.80	1788	240	74.7	93.90	0.81
FLSES 250MR	55	1480	107	93.50	0.84	1484	99.3	94.20	0.82	1784	294	88.3	95.30	0.82
FLSES 280S	75	1482	143	94.00	0.85	1486	134	94.10	0.83	1784	401	119	94.50	0.84
FLSES 280M	90	1481	169	94.20	0.86	1485	158	94.30	0.84	1785	481	141	94.50	0.85
FLSES 315S	110	1483	208	94.50	0.85	1487	193	95.50	0.83	1786	588	173	95.00	0.84
FLSES 315M	132	1484	246	94.70	0.86	1487	231	94.80	0.84	1787	705	205	95.00	0.85
FLSES 315LA	160	1482	298	94.90	0.86	1486	279	95.00	0.84	1784	856	248	95.20	0.85
FLSES 315LB	200	1483	372	95.10	0.86	1487	348	95.20	0.84	1784	1071	310	95.40	0.85
FLSES 355LA	250	1487	459	95.10	0.87	1490	430	95.20	0.85	1788	1335	382	95.40	0.86
FLSES 355LAL	280	1486	508	95.10	0.88	1489	476	95.20	0.86	1787	1496	423	95.40	0.87
FLSES 355LB	315	1485	572	95.10	0.88	1488	535	95.20	0.86	1787	1683	476	95.40	0.87
FLSES 355LC	355	1484	637	95.10	0.89	1488	596	95.20	0.87	1787	1897	531	95.40	0.88
FLSES 355LD	400	1486	743	95.10	0.86	1487	696	95.20	0.84	1788	2136	619	95.40	0.85
FLSES 355LKB	450	1489	818	95.00	0.88	1491	774	95.20	0.85	1792	2398	686	95.80	0.86
FLSES 400LB	500	1488	909	95.00	0.88	1491	850	95.20	0.86	1792	2664	753	95.80	0.87
FLSES 450LA	550	1491	988	95.10	0.89	1492	926	95.10	0.87	1793	2929	819	95.80	0.88
FLSES 450LB	675	1490	1241	95.10	0.87	1492	1163	95.10	0.85	1792	3597	1028	95.80	0.86
FLSES 450LD	800	1492	1437	95.10	0.89	1494	1378	95.10	0.85	1794	4258	1205	95.80	0.87
FLSES 450LD	900	1491	1636	95.10	0.88	1493	1551	95.10	0.85	1793	4793	1355	95.80	0.87
6 poles														
FLSES 90SL	0.75	940	2	77.10	0.74	954	1.95	78.10	0.68	1158	6.2	1.75	81.50	0.65
FLSES 90L	1.1	930	2.9	78.10	0.74	950	2.85	79.30	0.68	-	-	-	-	-
FLSES 100LG	1.5	954	3.8	80.40	0.74	966	3.65	81.90	0.70	-	-	-	-	-
FLSES 112MG	2.2	954	5.45	81.80	0.75	964	5.4	82.00	0.69	-	-	-	-	-
FLSES 132SM	3	960	7.05	84.20	0.77	968	6.75	85.60	0.72	1172	24.4	6	87.50	0.72
FLSES 132M	4	954	9.1	84.60	0.79	966	8.8	85.90	0.74	1170	32.6	7.7	87.90	0.74
FLSES 132M	5.5	960	13	85.50	0.75	970	13	86.40	0.68	-	-	-	-	-
FLSES 160M	7.5	970	16.7	87.80	0.77	976	16.6	87.90	0.72	1180	60.7	14.8	89.60	0.71
FLSES 160LUR	11	972	24	88.70	0.79	978	23.4	88.80	0.74	1178	89.2	20.7	90.30	0.74
FLSES 180L	15	968	31	89.70	0.82	976	29.6	90.20	0.78	1176	122	26.2	91.20	0.79
FLSES 200LU	18.5	974	38.5	90.40	0.81	980	37.6	90.80	0.75	1178	150	32.7	92.20	0.77

IMfinity® 3-phase induction motors - IE2 - IE3 - IE4 - Non IE Efficiency

IP55 Cast iron frame

Electrical and mechanical characteristics

IE2 - Powered by the drive

Type	400V / 50Hz				Rated torque M_n at S1 continuous duty					400V / 87Hz Δ				Maximum mechanical speed ¹
	Rated power	Rated speed	Rated current	Power factor	10Hz	17Hz	25Hz	50Hz	87Hz	Rated power	Rated current	Efficiency	Power factor	
	P_n kW	N min ⁻¹	I_n A	$\cos \phi$ 4/4	N.m	N.m	N.m	N.m	N.m	P_n kW	I_n A	$\cos \phi$ 4/4	$\cos \phi$ 4/4	
2 poles														
FLSES 80 L	0.75	2845	1.6	0.86	2.3	2.5	2.5	2.5	1.4	1.3	4928	3.1	0.86	13500
FLSES 80 L	1.1	2850	2.3	0.85	3.2	3.7	3.7	3.7	2.1	1.9	4936	4.6	0.85	13500
FLSES 90 SL	1.5	2855	3	0.87	4.3	5.0	5.0	5.0	2.9	2.6	4945	6	0.87	11700
FLSES 90 L	2.2	2855	4.4	0.86	6.3	7.4	7.4	7.4	4.2	3.8	4945	8.9	0.86	11700
FLSES 100 L	3.0	2855	5.7	0.87	8.6	10.1	10.1	10.1	5.8	5.2	4945	11.4	0.87	9900
FLSES 112 MG	4	2925	7.6	0.86	11.1	13.1	13.1	13.1	7.5	7.0	5066	14.7	0.86	9900
FLSES 132 SM	5.5	2925	10.3	0.86	15.3	18	18	18	10.3	9.6	5066	20.6	0.86	6700
FLSES 132 SM	7.5	2920	13.9	0.87	20.8	23.3	24.5	24.5	14.1	13.1	5058	28.2	0.87	6700
FLSES 132 M	9	2925	16.8	0.86	25.0	27.9	29.4	29.4	16.9	15.7	5066	33.1	0.86	6700
FLSES 160 M	11	2950	20.3	0.86	30.3	33.8	35.6	35.6	20.5	19.1	5110	39.1	0.86	6030
FLSES 160 M	15	2945	26.7	0.89	41.3	46.2	48.6	48.6	27.9	26.1	5101	52.4	0.89	6030
FLSES 160 L	18.5	2935	32.7	0.89	51.2	57.2	60.2	60.2	34.6	32.2	5084	65.1	0.89	5670
FLSES 180 MR	22	2940	39.3	0.88	57.6	64.4	67.8	71.5	38.9	36.3	5092	74.3	0.88	5670
FLSES 200 LU	30	2950	53.9	0.87	82.5	87.4	97.1	97.1	-	-	-	-	-	4500
FLSES 200 LU	37	2945	65.2	0.88	96	108	120	120	-	-	-	-	-	4500
FLSES 225 MR	45	2952	80.7	0.86	117	131	146	146	-	-	-	-	-	4320
FLSES 250 M	55	2968	95.8	0.88	142	159	177	177	-	-	-	-	-	4050
FLSES 280 S	75	2964	135	0.91	191	216	243	243	-	-	-	-	-	3600
FLSES 280M	90	2965	164	0.91	229	259	291	291	-	-	-	-	-	3600
FLSES 315S	110	2976	202	0.9	278	315	353	353	-	-	-	-	-	3600
FLSES 315 M	132	2976	243	0.9	333	378	423	423	-	-	-	-	-	3600
FLSES 315 LA	160	2975	293	0.9	404	458	513	513	-	-	-	-	-	3600
FLSES 315 LB	200	2975	365	0.9	506	573	642	642	-	-	-	-	-	3600
FLSES 355 LA	250	2978	461	0.89	785	804	802	802	-	-	-	-	-	3600
FLSES 355 LB	315	2983	580	0.89	793	900	1008	1008	-	-	-	-	-	3600
FLSES 355 LC	355	2981	663	0.88	895	1015	1137	1137	-	-	-	-	-	3600
FLSES 355 LD	400	2987	715	1	1065	1091	1130	1130	-	-	-	-	-	3600
FLSES 355 LKB	450	2990	807	0.91	1295	1367	1439	1439	-	-	-	-	-	3600
FLSES 400 LB	560	2988	975	0.94	1342	1521	1789	1789	-	-	-	-	-	3600
4 poles														
FLSES 80 LG	0.75	1445	1.7	0.79	4.5	5.0	5.0	5.0	2.8	1.3	2503	3.31	0.79	11700
FLSES 90 SL	1.1	1440	2.4	0.81	6.6	7.3	7.3	7.3	4.2	1.9	2494	4.56	0.81	11700
FLSES 90 L	1.5	1440	3.2	0.82	9.0	10	10	10	5.7	2.6	2494	6.17	0.82	9900
FLSES 100 L	2.2	1445	4.55	0.82	13.1	14.5	14.5	14.5	8.3	3.8	2503	8.9	0.82	9900
FLSES 100 LG	3	1450	6.05	0.83	17.8	19.8	19.8	19.8	11.4	5.2	2511	11.5	0.83	9900
FLSES 112 MU	4	1450	7.9	0.84	23.7	26.3	26.3	26.3	15.1	7	2511	15.6	0.84	9900
FLSES 132 SM	5.5	1458	10.7	0.83	32.4	32.4	36.0	36.0	20.7	9.6	2525	20.9	0.83	6700
FLSES 132 M	7.5	1454	14.4	0.85	44.4	44.4	49.3	49.3	28.3	13.1	2518	27.9	0.85	6700
FLSES 132 M	9	1454	17.5	0.83	53.2	53.2	59.1	59.1	34.0	15.7	2518	33.6	0.83	6700
FLSES 160 M	11	1468	20.8	0.84	60.9	68.0	71.6	71.6	41.2	19.1	2543	40.2	0.84	6030
FLSES 160 L	15	1462	28	0.85	83.3	93.1	98	98	56.3	26.1	2532	54.5	0.85	6030
FLSES 180 MT	18.5	1464	34.7	0.84	95	107	119	121	69	31.7	2536	66.2	0.84	6030
FLSES 180 L	22	1466	41	0.84	114	129	143	143	82	38.3	2539	80.4	0.84	6030
FLSES 200 LU	30	1470	56.3	0.83	166	185	195	195	112	52.2	2546	110	0.83	4500
FLSES 225 SR	37	1470	69.6	0.83	204	228	240	240	138	64.4	2546	135	0.83	4320
FLSES 225 M	45	1484	82	0.84	247	276	290	290	167	78.3	2570	162	0.84	4050
FLSES 250 MR	55	1482	102	0.83	301	336	354	354	203	95.7	2567	198	0.83	4050
FLSES 280 S	75	1485	148	0.84	382	433	485	485	274	-	-	-	-	2160
FLSES 280 M	90	1485	177	0.84	458	519	581	581	329	-	-	-	-	2160
FLSES 315 S	110	1486	210	0.86	744	744	709	709	404	-	-	-	-	2160
FLSES 315 M	132	1487	250	0.87	856	872	852	852	486	-	-	-	-	2160
FLSES 315 LA	160	1484	303	0.87	982	1019	1033	1033	585	-	-	-	-	2160
FLSES 315 LB	200	1486	374	0.87	1208	1260	1289	1289	704	-	-	-	-	2160
FLSES 355 LA	250	1488	465	0.87	1565	1607	1605	1605	915	-	-	-	-	2160
FLSES 355 LAL	280	1487	507	0.87	1733	1785	1798	1798	1036	-	-	-	-	2160
FLSES 355 LB	315	1488	594	0.87	1592	1805	2022	2022	1150	-	-	-	-	2160
FLSES 355 LC	355	1487	670	0.87	1786	2035	2280	2280	1290	-	-	-	-	2160
FLSES 355 LD	-	-	-	-	-	-	-	-	-	-	-	-	-	2160
FLSES 355 LKB	450	1489	837	0.88	2592	2736	2880	2880	1670	-	-	-	-	2610
FLSES 400 LB	500	1489	925	0.88	2413	2735	3217	3217	1834	-	-	-	-	2610
FLSES 450 LA	550	1492	1011	0.89	2816	3168	3520	3520	2023	-	-	-	-	1800
FLSES 450 LB	675	1491	1268	0.87	3458	3891	4323	4323	2484	-	-	-	-	1800
FLSES 450 LD	800	1493	1478	0.88	4094	4606	5117	5117	2941	-	-	-	-	1800
FLSES 450 LD	900	1492	1666	0.88	4609	5185	5761	5761	3311	-	-	-	-	1800
6 poles														
FLSES 90 SL	0.75	945	2	0.70	7.6	7.6	7.6	7.6	4.4	1.31	1637	3.7	0.70	11700
FLSES 90 L	1.1	940	2.9	0.71	11.2	11.2	11.2	11.2	6.4	1.91	1628	5.4	0.71	11700
FLSES 100 LG	1.5	930	3.8	0.71	14.9	14.9	14.9	14.9	8.6	2.61	1611	7.2	0.71	9900
FLSES 112MG	2.2	954	5.4	0.72	21.9	21.9	21.9	21.9	12.6	3.83	1652	10.3	0.72	9900
FLSES 132 SM	3	966	6.9	0.74	29.7	29.7	29.7	29.7	17.1	5.22	1673	13.1	0.74	6700
FLSES 132 M	4	962	8.8	0.77	39.7	39.7	39.7	39.7	22.8	6.96	1666	17.1	0.77	6700
FLSES 132 M	5.5	966	12.6	0.73	54.4	54.4	54.4	54.4	31.3	9.57	1673	24	0.73	6700
FLSES 160 M	7.5	976	14	0.84	73.4	73.4	73.4	73.4	42.2	13.05	1690	30.9	0.84	6030
FLSES 160 LUR	11	974	20.6	0.84	103	108	108	108	62	19.14	1687	44.3	0.84	6030
FLSES 180 L	15	972	27.9	0.84	118	132	147	147	84	26.10	1684	58.3	0.84	6030
FLSES 200 LU	18.5	978	34.4	0.84	145	163	181	181	104	32.19	1694	71.1	0.84	4500
FLSES 200 LU	22	972	41.5	0.84	173	194	216	216	124	38.28	1684	85.4	0.84	4500
FLSES 225 MG	30	984	55.9	0.84	262	291	291	291	167	52.20	1704	107	0.84	4050
FLSES 250 M	37	986	68	0.85	322	358	358	358	206	64.38	1708	131	0.85	4050
FLSES 280 S	45	986	89	0.85	343	389	436	436	247	-	-	-	-	1740
FLSES 280 M	55	986	108	0.85	420	476	533	533	302	-	-	-	-	1740
FLSES 315 S	75	990	155	0.80	604	685	767	767	412	-	-	-	-	

IMfinity® 3-phase induction motors - IE2 - IE3 - IE4 - Non IE Efficiency

IP55 Cast iron frame

Electrical and mechanical characteristics

IE3 - Powered by the mains

Type	Rated power P _n kW	Rated torque M _n N.m	Starting torque/ Rated torque M _d /M _n	Maximum torque/ Rated torque M _m /M _n	Starting current/ Rated current I _d /I _n	Moment of inertia J kg.m ²	Weight IM B3 kg	Noise LP db(A)	400V / 50Hz							
									Rated speed N _n min ⁻¹	Rated current I _n A	Efficiency IEC 60034-2-1 2014			Power factor		
											4/4	3/4	2/4	4/4	3/4	2/4
2 poles																
FLSES 80L	0.75	2.5	2.8	3.6	7	0.00095	16.1	59	2885	1.6	82.60	82.70	80.50	0.82	0.75	0.62
FLSES 80LG	1.1	3.65	2.45	3.15	6.8	0.00201	22.5	59	2885	2.2	85.60	86.60	85.90	0.85	0.79	0.68
FLSES 90SL	1.5	4.95	2.9	3	7	0.00223	24.6	68	2890	3	85.10	86.10	85.40	0.85	0.79	0.68
FLSES 90LU	2.2	7.25	3.4	3.25	8.15	0.00292	28.2	70	2895	4.25	87.00	88.20	88.10	0.86	0.80	0.70
FLSES 100L	3	9.9	3.2	3.6	8.1	0.00364	35.1	66	2895	5.75	87.10	88.10	87.80	0.86	0.81	0.70
FLSES 112MG	4	13.1	2.10	2.95	7.35	0.00941	44.8	66	2920	7.3	88.50	89.50	89.40	0.89	0.85	0.77
FLSES 132SM	5.5	17.9	2	2.8	6.4	0.00974	69.3	67	2935	10.3	90.00	90.80	90.40	0.86	0.82	0.73
FLSES 132SM	7.5	24.4	2.05	2.9	6.95	0.01102	74.6	67	2940	13.8	91.20	92.00	91.80	0.86	0.82	0.75
FLSES 132M	9	29.2	2.45	3.2	7.55	0.01203	78.2	67	2940	16.8	91.30	92.00	91.70	0.85	0.80	0.72
FLSES 160M	11	35.6	3.34	3.04	8.24	0.0712	112	68	2950	19.9	91.90	92.40	92.00	0.87	0.83	0.75
FLSES 160M	15	48.6	2.9	2.9	7.25	0.0551	133	68	2950	26.7	92.40	93.10	93.10	0.88	0.85	0.79
FLSES 160LUR	18.5	59.9	2.85	2.75	7.4	0.0626	135	69	2950	32.9	92.50	93.20	93.20	0.88	0.86	0.79
FLSES 180MUR	22	71.2	3	3.4	8.05	0.1012	195	74	2952	38	93.60	94.10	93.80	0.89	0.87	0.81
FLSES 200LU	30	97.1	2.1	3.05	7.25	0.1186	210	71	2950	53.1	93.90	94.30	94.00	0.87	0.84	0.77
FLSES 200LU	37	120	2.05	3.35	6.95	0.1388	230	75	2945	64.5	94.00	94.60	94.50	0.88	0.86	0.80
FLSES 225MR	45	145	2.27	3.07	7.17	0.1597	254	71	2956	81.8	94.40	94.70	94.40	0.84	0.80	0.70
FLSES 250M	55	177	2.1	3.20	7.65	0.3356	378	78	2968	95.3	94.50	94.60	93.70	0.88	0.85	0.79
FLSES 280S	75	241	2.07	2.73	7	0.48	565	80	2966	125	95.00	95.30	95.30	0.91	0.89	0.85
FLSES 280M	90	290	2.18	2.78	7.38	0.57	615	80	2967	151	95.30	95.70	95.50	0.90	0.89	0.85
FLSES 315S	110	353	2.07	2.57	6.6	1.45	940	80	2975	184	95.90	95.50	94.60	0.90	0.89	0.85
FLSES 315M	132	424	2.07	2.5	6.7	1.25	1015	80	2975	221	96.00	96.10	95.60	0.90	0.89	0.84
FLSES 315LA	160	514	2.09	2.83	6.66	1.34	1070	80	2972	267	96.00	96.10	95.70	0.90	0.89	0.84
FLSES 315LB	200	643	2.11	2.86	6.88	1.45	1150	80	2973	334	96.30	96.50	96.30	0.90	0.88	0.84
FLSES 355LA	250	802	2.19	2.85	6.83	3.02	1590	82	2978	428	96.00	96.00	95.30	0.88	0.86	0.80
FLSES 355LB	315	1008	2.55	3	7.82	3.62	1650	82	2982	537	96.30	96.50	96.40	0.88	0.86	0.82
FLSES 355LC	355	1137	2.8	2.67	7	3.64	1660	82	2981	612	96.30	96.40	96.20	0.87	0.86	0.80
FLSES 355LD	400	1278	1.88	2.59	7	3.7	1800	82	2988	670	97.00	97.10	96.90	0.89	0.88	0.85
FLSES 355LKB	450	1439	2.2	2.56	12.7	6.4	2550	93	2991	747	96.60	96.10	95.10	0.90	0.87	0.80
FLSES 400LB	560	1789	1.2	5.64	9.9	7.4	2640	93	2988	902	96.84	96.35	95.18	0.93	0.91	0.87
4 poles																
FLSES 80LG	0.75	4.95	2.2	3.15	6.6	0.00335	22	57	1452	1.65	83.80	84.40	83.10	0.79	0.71	0.58
FLSES 90SL	1.1	7.25	2.4	3.2	7.5	0.00418	24.6	48	1450	2.3	84.90	85.80	85.00	0.81	0.74	0.61
FLSES 90LU	1.5	9.85	2.85	3.55	7.34	0.00524	28.2	51	1454	3.25	85.40	85.80	84.10	0.78	0.70	0.56
FLSES 100LR	2.2	14.5	3.45	3.85	8.16	0.00676	36.4	49	1452	4.65	86.90	87.40	86.20	0.78	0.70	0.57
FLSES 100LG	3	19.6	2.45	3.25	7.27	0.01152	40.7	50	1462	5.95	88.70	89.30	88.70	0.82	0.76	0.64
FLSES 112MU	4	26.2	2.7	3.1	7.05	0.01429	48.7	0	1458	8.1	88.80	89.50	88.90	0.80	0.75	0.64
FLSES 132SM	5.5	35.9	2.85	3.65	8.35	0.02286	70.9	60	1462	10.5	90.10	90.70	90.20	0.84	0.78	0.67
FLSES 132MR	7.5	49.1	2.8	3.4	8.45	0.03313	89.4	61	1460	13.8	90.60	91.50	91.30	0.86	0.81	0.71
FLSES 160M	9	58.5	2.35	3.05	8.25	0.0601	105	59	1468	16.7	91.20	91.90	91.70	0.85	0.80	0.70
FLSES 160M	11	71.7	2.25	2.85	7.6	0.0712	115	59	1466	20.1	91.70	92.70	92.80	0.86	0.82	0.73
FLSES 160LUR	15	97.4	2.3	3.2	8.04	0.0954	140	58	1470	27.2	92.30	93.00	92.90	0.86	0.82	0.72
FLSES 180M	18.5	120	3.05	3.35	8.05	0.1333	165	67	1470	34.1	92.80	93.50	93.40	0.84	0.80	0.71
FLSES 180LUR	22	143	3.3	3.3	7.9	0.1555	190	68	1470	41.3	93.00	93.60	93.40	0.83	0.79	0.69
FLSES 200LU	30	194	3.05	2.9	7.25	0.2035	250	64	1474	54.9	93.90	94.40	94.20	0.84	0.80	0.70
FLSES 225S	37	238	2	2.65	6.75	0.5753	355	65	1484	67.5	94.00	94.40	94.10	0.84	0.80	0.71
FLSES 225M	45	289	2.11	2.71	6.68	0.6482	380	64	1486	84.4	94.90	95.20	94.90	0.81	0.76	0.66
FLSES 250MR	55	354	2.05	2.45	6.9	0.7701	440	67	1482	101	94.80	95.20	95.10	0.83	0.79	0.70
FLSES 280S	75	482	2.4	2.84	7.6	0.85	600	70	1483	137	95.00	95.10	94.40	0.84	0.80	0.71
FLSES 280M	90	579	2.69	2.67	8.1	0.98	645	70	1485	162	95.20	95.40	95.00	0.84	0.82	0.72
FLSES 315S	110	707	2.07	2.66	7.1	2.02	940	75	1486	195	95.60	95.70	95.20	0.85	0.81	0.73
FLSES 315M	132	848	2.77	2.76	6.76	2.09	985	75	1487	234	95.90	95.90	95.60	0.85	0.82	0.76
FLSES 315LA	160	1030	2.3	2.55	6.48	2.72	1055	75	1485	277	96.00	96.30	96.10	0.87	0.85	0.78
FLSES 315LB	200	1287	2.75	3	7.2	2.86	1245	75	1485	353	96.20	96.40	96.00	0.85	0.81	0.72
FLSES 355LA	250	1604	2.55	3.1	7.54	4.9	1445	80	1488	436	96.30	96.40	95.60	0.86	0.82	0.71
FLSES 355LAL	280	1798	2.4	2.94	7.48	5.8	1560	80	1489	483	96.20	96.50	96.30	0.87	0.85	0.78
FLSES 355LB	315	2020	2.46	2.9	7.5	6.56	1720	80	1489	549	96.30	96.50	96.20	0.86	0.84	0.76
FLSES 355LC	355	2280	2.36	2.74	7.55	6.56	1740	82	1488	605	96.30	96.60	96.40	0.88	0.86	0.80
FLSES 355LD	400	2562	1.69	2.74	7.85	6.6	1750	82	1491	680	96.40	96.70	96.60	0.88	0.87	0.83
FLSES 355LKB	450	2880	1.47	3.47	8.46	11.5	2530	82	1490	775	96.78	96.75	96.35	0.87	0.83	0.74
FLSES 400LB	500	3217	1.32	3.1	7.65	11.5	2630	82	1490	857	96.50	96.67	96.39	0.87	0.85	0.77
FLSES 450LA	550	3520	1.48	2.2	6.7	23.7	3100	84	1492	936	96.40	96.60	96.20	0.88	0.87	0.82
FLSES 450LB	675	4323	1.67	2.74	6.9	26.55	3775	84	1491	1174	96.50	96.60	96.40	0.86	0.85	0.80
FLSES 450LD	800	5117	2.1	2.9	8.5	34.8	4400	84	1493	1368	97.00	96.80	96.40	0.87	0.85	0.77
FLSES 450LD	900	5761	1.9	2.58	7.6	34.8	4400	84	1492	1543	96.80	96.60	96.40	0.87	0.85	0.77
6 poles																
FLSES 90SL	0.75	7.6	1.84	2.3	4.45	0.00378	24.2	40	950	1.9	79.10	80.10	78.30	0.72	0.63	0.49
FLSES 90LU	1.1	11	2.25	2.55	4.8	0.00519	29.3	57	954	2.75	81.70	82.30	80.30	0.71	0.62	0.48
FLSES 100LG	1.5	14.8	2.35	2.8	5.65	0.01523	41.3	47	966	3.6						

IMfinity® 3-phase induction motors - IE2 - IE3 - IE4 - Non IE Efficiency

IP55 Cast iron frame

Electrical and mechanical characteristics

IE3 - Powered by the mains

Type	Rated power at 50Hz	380V / 50Hz				415V / 50Hz				460V / 60Hz				
		Rated speed	Rated current	Efficiency	Power factor	Rated speed	Rated current	Efficiency	Power factor	Rated speed	Rated torque at 60Hz	Rated current	Efficiency	Power factor
		P_n kW	N_n min ⁻¹	I_n A	η 4/4	$\cos \varphi$ 4/4	N_n min ⁻¹	I_n A	η 4/4	$\cos \varphi$ 4/4	N_n min ⁻¹	N_n min ⁻¹	I_n A	η 4/4
2 poles														
FLSES 80L	0.75	2870	1.65	82.40	0.84	2895	1.6	83.00	0.79	3505	2.04	1.4	83.70	0.79
FLSES 80LG	1.1	2870	2.3	84.70	0.86	2895	2.15	85.90	0.83	3505	3.0	1.95	84.80	0.83
FLSES 90SL	1.5	2870	3.1	84.30	0.87	2900	2.95	85.30	0.83	3505	4.1	2.65	86.10	0.83
FLSES 90LU	2.2	2875	4.4	86.00	0.89	2905	4.1	87.50	0.85	3510	6	3.7	88.20	0.85
FLSES 100L	3	2875	5.95	87.10	0.88	2910	5.6	87.50	0.85	-	-	-	-	-
FLSES 112MG	4	2910	7.65	88.10	0.90	2930	7.15	88.90	0.88	3535	10.8	6.4	89.90	0.88
FLSES 132SM	5.5	2925	10.6	89.20	0.88	2940	9.9	90.50	0.85	3545	14.8	9	90.80	0.85
FLSES 132SM	7.5	2930	14.4	90.10	0.88	2945	13.5	91.50	0.85	3550	20.2	12	92.20	0.85
FLSES 132M	9	2935	17.3	91.10	0.87	2950	16.3	91.40	0.84	3554	24.2	14.6	92.30	0.84
FLSES 160M	11	2940	20.8	92.00	0.88	2954	19.4	92.40	0.85	3554	29.6	17.3	92.40	0.86
FLSES 160M	15	2940	27.8	92.00	0.89	2956	25.7	92.70	0.87	3556	40.3	23	93.20	0.88
FLSES 160LUR	18.5	2935	34.1	92.40	0.89	2952	31.8	92.70	0.87	3558	49.7	28.4	93.20	0.87
FLSES 180MUR	22	2945	40	93.00	0.90	2958	37.1	93.80	0.88	3560	59	33.1	93.80	0.88
FLSES 200LU	30	2945	55.3	93.50	0.88	2954	51.7	94.00	0.86	3554	80.6	46.4	94.00	0.87
FLSES 200LU	37	2935	67.6	93.70	0.89	2950	62.8	94.30	0.87	3552	99.5	56.3	94.20	0.88
FLSES 225MR	45	2950	84.2	94.30	0.86	2960	80.7	94.40	0.82	3564	121	70.6	95.10	0.84
FLSES 250M	55	2966	99.1	94.30	0.89	2972	87.2	94.60	0.87	3574	147	83.3	94.30	0.88
FLSES 280S	75	2962	132	94.70	0.91	2968	122	95.20	0.90	3566	201	110	94.10	0.91
FLSES 280M	90	2961	158	95.00	0.91	2971	146	95.50	0.90	3567	241	132	95.00	0.90
FLSES 315S	110	2975	194	95.50	0.90	2979	177	95.90	0.90	3575	294	161	95.00	0.90
FLSES 315M	132	2971	233	95.70	0.90	2976	213	96.00	0.90	3575	353	193	95.40	0.90
FLSES 315LA	160	2969	281	96.00	0.90	2976	260	96.20	0.89	3575	427	233	95.80	0.90
FLSES 315LB	200	2969	351	96.30	0.90	2974	324	96.60	0.89	3575	534	291	95.80	0.90
FLSES 355LA	250	2976	445	95.90	0.89	2982	410	96.30	0.88	3578	667	372	95.80	0.88
FLSES 355LB	315	2978	565	96.20	0.88	2982	523	96.40	0.87	3583	840	469	95.80	0.88
FLSES 355LC	355	2977	640	95.80	0.88	2982	589	96.30	0.87	3581	947	535	95.80	0.87
FLSES 355LD	400	2987	694	97.00	0.90	2991	647	96.80	0.89	3589	1064	585	96.50	0.89
FLSES 355LKB	450	2990	779	96.50	0.91	2991	724	96.65	0.90	3592	1196	649	96.65	0.90
FLSES 400LB	560	2987	947	96.74	0.93	2990	874	96.92	0.92	3590	1490	786	97.03	0.92
4 poles														
FLSES 80LG	0.75	1445	1.65	83.10	0.82	1454	1.6	84.00	0.78	1762	4.06	1.45	85.70	0.76
FLSES 90SL	1.1	1440	2.4	84.10	0.83	1454	2.3	84.90	0.79	1758	5.98	2.05	86.50	0.78
FLSES 90LU	1.5	1445	3.3	85.30	0.81	1456	3.2	85.60	0.76	1762	8.13	2.9	86.90	0.75
FLSES 100LR	2.2	1445	4.75	86.70	0.81	1456	4.65	87.00	0.76	-	-	-	-	-
FLSES 100LG	3	1456	6.15	88.30	0.84	1462	5.95	88.80	0.79	1768	16.2	5.2	89.90	0.80
FLSES 112MU	4	1458	8.3	88.60	0.83	1462	8.05	89.40	0.78	1764	21.65	7.65	85.50	0.77
FLSES 132SM	5.5	1456	10.9	89.60	0.86	1466	10.3	90.20	0.82	1768	29.7	9.2	91.70	0.82
FLSES 132MR	7.5	1456	14.3	90.40	0.88	1464	13.5	91.00	0.85	1768	40.5	12.1	92.00	0.85
FLSES 160M	9	1462	17.3	90.90	0.87	1472	16.5	91.60	0.83	1772	48.5	14.6	92.40	0.84
FLSES 160M	11	1462	21	91.40	0.87	1468	19.5	92.20	0.85	1772	59.3	17.5	92.90	0.85
FLSES 160LUR	15	1466	28.6	92.10	0.87	1474	26.8	92.60	0.84	1774	80.7	23.8	93.40	0.85
FLSES 180M	18.5	1464	35.6	92.60	0.86	1472	33.5	93.00	0.83	1774	99.6	29.9	93.60	0.83
FLSES 180LUR	22	1466	42.4	93.00	0.85	1474	40.2	93.20	0.82	1776	118	35.9	93.70	0.82
FLSES 200LU	30	1472	56.8	93.60	0.85	1476	53.7	94.20	0.82	1780	161	48.3	94.50	0.83
FLSES 225S	37	1482	70.5	93.90	0.85	1486	65.7	94.50	0.83	1786	198	59.4	94.50	0.83
FLSES 225M	45	1484	87	94.60	0.83	1486	82.5	95.00	0.80	1788	240	74.1	95.30	0.80
FLSES 250MR	55	1480	105	94.60	0.84	1484	98.4	95.00	0.82	1784	294	88.2	95.40	0.82
FLSES 280S	75	1483	142	94.70	0.85	1486	133	94.80	0.83	1784	401	117	95.40	0.84
FLSES 280M	90	1481	168	95.00	0.86	1485	159	95.10	0.83	1785	481	141	95.40	0.84
FLSES 315S	110	1485	204	95.40	0.86	1487	194	95.40	0.83	1786	588	172	95.80	0.84
FLSES 315M	132	1484	241	95.60	0.87	1487	229	95.80	0.84	1787	705	203	96.00	0.85
FLSES 315LA	160	1482	288	95.80	0.88	1486	269	96.10	0.86	1784	856	249	96.20	0.85
FLSES 315LB	200	1483	367	96.20	0.86	1486	349	96.10	0.83	1786	1069	307	96.20	0.85
FLSES 355LA	250	1487	450	96.00	0.88	1490	425	96.20	0.85	1788	1335	379	96.20	0.86
FLSES 355LAL	280	1487	503	96.00	0.88	1490	471	96.10	0.86	1787	1496	420	96.20	0.87
FLSES 355LB	315	1486	567	96.00	0.88	1488	530	96.30	0.86	1787	1683	472	96.20	0.87
FLSES 355LC	355	1486	631	96.00	0.89	1489	592	96.00	0.87	1786	1898	532	96.20	0.87
FLSES 355LD	400	1486	709	96.30	0.89	1492	678	96.60	0.85	1788	2136	607	96.20	0.86
FLSES 355LKB	450	1489	804	96.60	0.88	1491	760	96.90	0.85	1792	2398	677	97.00	0.86
FLSES 400LB	500	1488	897	96.25	0.88	1491	837	96.60	0.86	1792	2664	746	96.70	0.87
FLSES 450LA	550	1491	974	96.40	0.89	1492	912	96.40	0.87	1793	2929	812	96.60	0.88
FLSES 450LB	675	1490	1222	96.50	0.87	1492	1145	96.50	0.85	1792	3597	1019	96.70	0.86
FLSES 450LD	800	1492	1408	97.00	0.89	1494	1350	97.00	0.85	1794	4258	1189	97.10	0.87
FLSES 450LD	900	1491	1605	96.80	0.88	1493	1522	96.80	0.85	1793	4793	1340	96.90	0.87
6 poles														
FLSES 90SL	0.75	945	1.95	78.90	0.75	956	1.9	79.40	0.69	1160	6.17	1.7	82.50	0.67
FLSES 90LU	1.1	945	2.8	81.00	0.74	958	2.75	81.70	0.68	-	-	-	-	-
FLSES 100LG	1.5	962	3.7	83.30	0.74	970	3.6	84.10	0.69	-	-	-	-	-
FLSES 112MU	2.2	970	6.95	86.30	0.76	974	6.75	86.80	0.71	-	-	-	-	-
FLSES 132SM	3	966	9.3	86.80	0.75	972	9.15	87.00	0.70	-	-	-	-	-
FLSES 132M	4	962	12	88.00	0.79	970	11.5	88.50	0.75	-	-	-	-	-
FLSES 132MU	5.5	962	12.1	88.00	0.78	970	11.7	88.50	0.74	-	-	-	-	-
FLSES 160MU	7.5	974	18.2	89.10	0.79	980	17.1	89.60	0.74	-	-	-	-	-
FLSES 180L	11	978	23	90.70	0.80	984	22.3	91.20	0.75	1182	88.9	20	92.00	0.75
FLSES 180LUR	15	976	32.8	91.20	0.76	982	31.7	91.40	0.72	1182	121	28.5	91.70	0.72
FLSES 200LU	18.5	976	38	91.70	0.81	980	36	92.10	0.78	-	-	-	-	-
FLSES 200LU	22	978	43.6											

IMfinity® 3-phase induction motors - IE2 - IE3 - IE4 - Non IE Efficiency

IP55 Cast iron frame

Electrical and mechanical characteristics

IE3 - Powered by the drive

Type	400V / 50Hz				Rated torque M_n at S1 continuous duty					400V / 87Hz Δ				Maximum mechanical speed ¹
	Rated power	Rated speed	Rated current	Power factor	10Hz	17Hz	25Hz	50Hz	87Hz	Rated power	Rated speed	Rated current	Power factor	
	P_n kW	N_n min ⁻¹	I_n A	cos φ 4/4	N.m	N.m	N.m	N.m	N.m	P_n kW	N_n min ⁻¹	I_n A	cos φ 4/4	
2 poles														
FLSES 80 L	0.75	2885	1.6	0.83	2.3	2.5	2.5	2.5	1.4	1.3	4997	3	0.83	13500
FLSES 80 LG	1.1	2885	2.3	0.85	3.1	3.7	3.7	3.7	2.1	1.9	4997	4.3	0.85	13500
FLSES 90 SL	1.5	2890	3	0.85	4.2	5	5	5	2.8	2.6	5006	5.9	0.85	11700
FLSES 90 LU	2.2	2895	4.3	0.86	6.2	7.3	7.3	7.3	4.2	3.8	5014	8.2	0.86	11700
FLSES 100 L	3	2895	5.8	0.86	8.4	9.9	9.9	9.9	5.7	5.2	5014	11.3	0.86	9900
FLSES 112 MG	4	2920	7.5	0.87	11.1	13.1	13.1	13.1	7.5	7	5058	14.7	0.87	9900
FLSES 132 SM	5.5	2935	10.2	0.87	15.2	17.9	17.9	17.9	10.3	9.6	5084	20.2	0.87	6700
FLSES 132 SM	7.5	2940	13.9	0.86	20.7	23.2	24.4	24.4	14.0	13.1	5092	27	0.86	6700
FLSES 132 M	9	2935	17.9	0.87	29.2	29.2	29.2	29.2	16.8	15.7	5155	31.2	0.87	5220
FLSES 160 M	11	2956	19.3	0.89	30.2	33.7	35.5	35.5	20.4	19.1	5120	38.2	0.89	6030
FLSES 160 M	15	2950	26.7	0.88	41.3	46.2	48.6	48.6	27.9	26.1	5110	52.4	0.88	6030
FLSES 160 LUR	18.5	2950	32.9	0.88	50.9	56.9	59.9	59.9	34.4	32.2	5110	65.1	0.88	4500
FLSES 180 MUR	22	2952	38	0.89	60.5	67.6	71.2	71.2	40.9	38.3	5113	75.8	0.89	4500
FLSES 200 LU	30	2950	53.1	0.87	82.5	87.4	97.1	97.1	-	-	-	-	-	4500
FLSES 200 LU	37	2945	64.5	0.88	96	108	120	120	-	-	-	-	-	4700
FLSES 225 MR	45	2950	78.2	0.88	117	131	146	146	-	-	-	-	-	4320
FLSES 250 M	55	2968	95.3	0.88	142	159	177	177	-	-	-	-	-	4050
FLSES 280 S	75	2964	135	0.91	182	206	243	243	-	-	-	-	-	3600
FLSES 280 M	90	2965	164	0.91	218	247	291	291	-	-	-	-	-	3600
FLSES 315 S	110	2976	202	0.90	265	300	353	353	-	-	-	-	-	3600
FLSES 315 M	132	2976	243	0.90	318	360	423	423	-	-	-	-	-	3600
FLSES 315 LA	160	2971	293	0.90	385	436	513	513	-	-	-	-	-	3600
FLSES 315 LB	200	2975	365	0.90	482	546	642	642	-	-	-	-	-	3600
FLSES 355 LA	250	2978	461	0.89	748	766	802	802	-	-	-	-	-	3600
FLSES 355 LB	315	2979	580	0.89	756	857	1008	1008	-	-	-	-	-	3600
FLSES 355 LC	355	2981	663	0.88	853	966	1137	1137	-	-	-	-	-	3600
FLSES 355 LD	400	2990	807	0.91	1295	1367	1439	1439	-	-	-	-	-	3600
FLSES 355 LKB	450	2988	975	0.94	1342	1521	1789	1789	-	-	-	-	-	3600
FLSES 400 LB	560	2987	1036	0.89	1432	1611	1790	1790	-	-	-	-	-	3600
4 poles														
FLSES 80 LG	0.75	1450	1.7	0.80	4.5	5	5	5	2.8	1.3	2511	3.1	0.80	13500
FLSES 90 SL	1.1	1450	2.3	0.81	6.5	7.3	7.3	7.3	4.2	1.9	2511	4.5	0.81	11700
FLSES 90 LU	1.5	1454	3.2	0.79	8.9	9.9	9.9	9.9	5.7	2.6	2518	6.1	0.79	11700
FLSES 100 LR	2.2	1452	4.6	0.79	13.1	14.5	14.5	14.5	8.3	3.8	2515	8.8	0.79	9900
FLSES 100 LG	3	1460	6.1	0.81	17.6	19.6	19.6	19.6	11.3	5.2	2529	11.7	0.81	9900
FLSES 112 MU	4	1458	8.1	0.8	23.6	26.2	26.2	26.2	15.1	7	2525	15.4	0.8	9900
FLSES 132 SM	5.5	1462	10.5	0.84	32.3	32.3	35.9	35.9	20.6	9.6	2532	20.2	0.84	6700
FLSES 132 MR	7.5	1460	13.8	0.86	44.2	44.2	49.1	49.1	28.2	13.1	2529	27.3	0.86	6700
FLSES 160 M	9	1462	17.9	0.87	52.7	58.5	58.5	58.5	33.6	15.7	2572	31.2	0.87	2610
FLSES 160 M	11	1466	20.1	0.86	61.0	68.1	71.7	71.7	41.2	19.1	2539	39.5	0.86	6030
FLSES 160 LUR	15	1470	27.5	0.85	82.8	92.5	97.4	97.4	56.0	26.1	2546	53.4	0.85	5670
FLSES 180 M	18.5	1470	34.1	0.84	96	108	120	120	69	32.2	2546	66.7	0.84	5670
FLSES 180 LUR	22	1470	41.2	0.83	114	129	143	143	82	38.3	2546	80.1	0.83	4500
FLSES 200 LU	30	1474	54.9	0.84	165	184	194	194	111	52.2	2553	107	0.84	4500
FLSES 225 S	37	1484	67.5	0.84	202	226	238	238	137	64.4	2570	132	0.84	4320
FLSES 225 M	45	1484	82.9	0.83	247	276	290	290	167	78.3	2570	162	0.83	4320
FLSES 250 MR	55	1482	101	0.83	301	336	354	354	203	95.7	2567	198	0.83	4050
FLSES 280 S	75	1485	148	0.84	364	412	485	485	274	-	-	-	-	2610
FLSES 280 M	90	1485	177	0.84	434	494	581	581	329	-	-	-	-	2610
FLSES 315 S	110	1486	210	0.86	709	709	709	709	404	-	-	-	-	2610
FLSES 315 M	132	1487	250	0.87	815	830	852	852	486	-	-	-	-	2610
FLSES 315 LA	160	1484	303	0.87	935	970	1033	1033	585	-	-	-	-	2610
FLSES 315 LB	200	1486	374	0.87	1150	1200	1289	1289	704	-	-	-	-	2610
FLSES 355 LA	250	1488	465	0.87	1490	1530	1605	1605	915	-	-	-	-	2610
FLSES 355 LAL	280	1487	507	0.87	1650	1700	1798	1798	1036	-	-	-	-	2610
FLSES 355 LB	315	1488	594	0.87	1516	1719	2022	2022	1150	-	-	-	-	2610
FLSES 355 LC	355	1487	670	0.87	1710	1938	2280	2280	1290	-	-	-	-	2610
FLSES 355 LD	400	2562	719	0.88	2180	2370	2562	2562	1510	-	-	-	-	2610
FLSES 355 LKB	450	1489	837	0.876	2592	2736	2880	2880	1670	-	-	-	-	2610
FLSES 400 LB	500	1490	943	0.87	2564	2885	3205	3205	1834	-	-	-	-	2610
FLSES 450 LA	550	1492	1011	0.89	2816	3168	352	3520	2023	-	-	-	-	1800
FLSES 450 LB	675	1491	1268	0.87	3458	3891	4323	4323	2484	-	-	-	-	1800
FLSES 450 LD	800	1493	1478	0.88	4094	4606	5117	5117	2941	-	-	-	-	1800
FLSES 450 LD	900	1492	1666	0.88	4609	5185	5761	5761	3311	-	-	-	-	1800
6 poles														
FLSES 90 SL	0.75	950	1.9	0.72	7.6	7.6	7.6	7.6	4.3	1.3	1645	3.6	0.72	11700
FLSES 90 LU	1.1	954	2.8	0.71	11	11	11	11	6.3	1.9	1652	5.1	0.71	11700
FLSES 100 LG	1.5	962	3.8	0.74	13.1	14.8	14.8	14.8	8.4	2.6	1666	6.8	0.72	9900
FLSES 112 MU	2.2	968	5.4	0.70	21.7	21.7	21.7	21.7	12.5	3.8	1677	10	0.70	9900
FLSES 132 SM	3	972	6.9	0.73	29.5	29.5	29.5	29.5	17.0	5.2	1684	12.7	0.73	6700
FLSES 132 M	4	970	9.2	0.72	39.4	39.4	39.4	39.4	22.6	7	1680	17.2	0.72	6700
FLSES 132 MU	5.5	966	11.9	0.76	54.4	54.4	54.4	54.4	31.3	9.6	1673	22.7	0.76	6700
FLSES 160 MU	7.5	978	17.4	0.77	73.2	73.2	73.2	73.2	42.1	13.1	1694	30.2	0.77	6030
FLSES 180 L	11	982	22.6	0.77	102	107	107	107	61	19.1	1701	42.9	0.77	5670
FLSES 180 LUR	15	978	31.9	0.74	117	131	146	146	84	26.1	1694	61.3	0.74	4500
FLSES 200 LU	18.5	978	36.6	0.79	145	163	181	181	104	32.2	1694	70.6	0.79	4500
FLSES 200 LU	22	980	44.6	0.77	171	193	214	214	123	38.3	1697	84.7	0.77	4500
FLSES 225 M	30	986	55.3	0.84	262	291	291	291	167	52.2	1708	107	0.84	4050
FLSES 250 M	37	986	68.1	0.84	322	358	358	358	206	64.4	1708	131	0.84	4050
FLSES 280 S	45	986	89	0.85	327	371	436	436	247	-	-	-	-	1740
FLSES 280 M	55	986	108	0.85	400	453	533	533	302	-	-	-	-	1740
FLSES 315 S	75	990	155	0.80	575	652	767	767	412	-	-	-	-	1740
FLSES 315 M	90	991	187	0.80	650	737	867	867	494	-	-	-	-	1740
FLSES 315 LA	110	991	228	0.80	795	901	1060	1060	603	-	-	-	-	1740
FLSES 315 LB	132	990	272	0.80	955	1082	1273	1273	724	-	-	-	-	1740
FLSES 355 LA	160	993	310	0.85	1154	1307	1538	1538	878	-	-	-	-	1740
FLSES 355 LB	200	993	391	0.84	1442	1635	1923	1923	1090	-	-	-	-	1740
FLSES 355 LC	250	993	507	0.81	1803	2043	2404	2404	1370	-	-	-	-	1740
FLSES 355 LKA	315	993	631	0.82	2274	2575	3029	3029	1720	-	-	-	-	1740
FLSES 355 LKB	355	992	703	0.83	2561	2902	3414	3414	1940	-	-	-	-	1740
FLSES 355 LKC	400	990	758	0.84	3082	3472	3858	3858	2200	-				

IMfinity® 3-phase induction motors - IE2 - IE3 - IE4 - Non IE Efficiency

IP55 Cast iron frame

Electrical and mechanical characteristics

IE4 - Powered by the mains

Type	Rated power P _n kW	Rated torque M _n N.m	Starting torque/ Rated torque M _d /M _n	Maximum torque/ Rated torque M _m /M _n	Starting intensity/ Rated intensity I _d /I _n	Moment of inertia J kg.m ²	Weight IM B3 kg	Noise (50Hz) LP db(A)	400V 50Hz							
									Rated speed N _n min ⁻¹	Rated current I _n A	Efficiency IEC 60034-2-1 2014 η			Power factor Cos φ		
											4/4	3/4	2/4	4/4	3/4	2/4
2 poles																
FLSES 280 M	75	241	2.6	3.4	8.9	0.57	615	80	2977	126	95.6	95.9	95.8	0.90	0.89	0.85
FLSES 315 S	90	288	2.5	3.1	8.1	1.17	940	80	2982	150	96.0	96.0	95.5	0.90	0.89	0.85
FLSES 315 M	110	352	2.5	3.0	8.0	1.25	1015	80	2984	186	96.1	96.2	95.7	0.89	0.88	0.83
FLSES 315 LA	132	423	2.5	3.4	8.0	1.34	1070	80	2983	222	96.5	96.6	96.2	0.89	0.88	0.83
FLSES 315 LA	160	514	2.1	2.8	6.7	1.34	1070	80	2972	266	96.4	96.5	96.1	0.90	0.89	0.84
FLSES 315 LB	200	642	2.1	2.9	6.9	1.45	1150	80	2973	332	96.5	96.7	96.5	0.90	0.88	0.84
FLSES 355 LB	250	799	3.2	3.8	9.7	3.62	1650	83	2988	434	96.6	96.6	96.4	0.86	0.84	0.89
FLSES 355 LB	315	1009	2.6	3.0	7.9	3.62	1650	83	2982	534	96.8	96.8	96.6	0.88	0.86	0.81
FLSES 355 LC	355	1137	2.8	2.7	7.2	3.64	1660	83	2981	610	96.6	96.7	96.5	0.87	0.86	0.80
4 poles																
FLSES 315 S	75	481	2.7	4.5	9.6	1.84	940	67	1490	137	96.2	96.3	95.8	0.82	0.79	0.70
FLSES 315 S	90	577	2.5	4.1	8.4	1.84	940	67	1490	163	96.1	96.2	95.7	0.83	0.81	0.70
FLSES 315 M	110	706	3.3	3.3	8.0	2.09	980	70	1488	199	96.3	96.3	96.0	0.83	0.81	0.74
FLSES 315 LA	132	848	2.8	3.1	7.8	2.35	1055	70	1487	230	96.4	96.7	96.5	0.86	0.84	0.77
FLSES 315 LB	160	1028	3.4	3.8	8.8	2.86	1245	70	1487	288	96.7	96.9	96.5	0.83	0.79	0.71
FLSES 355 LAL	200	1281	3.3	4.1	9.8	5.80	1560	74	1491	364	96.7	97.0	96.8	0.82	0.80	0.71
FLSES 355 LB	250	1602	3.0	3.7	9.4	6.56	1650	74	1490	439	96.7	96.9	96.6	0.85	0.82	0.75
FLSES 355 LB	280	1793	2.8	4.3	8.7	6.56	1720	80	1491	492	96.7	96.5	96.0	0.85	0.82	0.66
FLSES 355 LC	315	2022	2.7	3.1	8.4	6.60	1700	74	1488	540	96.7	97.0	96.9	0.87	0.85	0.79
FLSES 355 LD	355	2271	1.9	3.2	8.8	6.60	1765	75	1493	594	96.9	97.1	95.5	0.89	0.86	0.80

Type	Rated power P _n kW	380V 50Hz				415V 50Hz				460V 60Hz			
		Rated speed	Rated current	Efficiency	Power factor	Rated speed	Rated current	Efficiency	Power factor	Rated speed	Rated current	Efficiency	Power factor
		N _n min ⁻¹	I _n A	η 4/4	Cos φ 4/4	N _n min ⁻¹	I _n A	η 4/4	Cos φ 4/4	N _n min ⁻¹	I _n A	η 4/4	Cos φ 4/4
2 poles													
FLSES 280 M	75	2967	131	95.6	0.91	2976	122	95.6	0.895	1572	110	95.4	0.90
FLSES 315 S	90	2977	159	95.8	0.90	2981	147	96.0	0.89	3584	133	95.4	0.89
FLSES 315 M	110	2975	193	96.0	0.90	2979	179	96.0	0.89	3583	162	95.6	0.89
FLSES 315 LA	132	2975	232	96.2	0.90	2979	214	96.4	0.89	3583	194	95.8	0.89
FLSES 315 LA	160	2970	284	96.3	0.89	2975	260	96.3	0.89	3581	233	95.8	0.90
FLSES 315 LB	200	2969	350	96.5	0.90	2974	324	96.6	0.89	3580	293	96.2	0.89
FLSES 355 LB	250	2984	452	96.6	0.87	2989	424	96.6	0.85	3586	378	96.4	0.86
FLSES 355 LB	315	2978	564	96.5	0.88	2984	521	96.7	0.87	3582	467	96.2	0.88
FLSES 355 LC	355	2977	635	96.5	0.88	2982	586	96.8	0.87	3582	532	96.2	0.87
4 poles													
FLSES 315 S	75	1487	143	96.1	0.83	1491	134	96.3	0.81	1792	121	96.2	0.81
FLSES 315 S	90	1488	169	96.1	0.84	1491	161	96.2	0.81	1791	145	96.2	0.81
FLSES 315 M	110	1487	205	96.0	0.85	1490	194	96.1	0.82	1791	173	96.2	0.83
FLSES 315 LA	132	1485	239	96.4	0.87	1488	224	96.5	0.85	1788	202	96.5	0.85
FLSES 315 LB	160	1486	300	96.6	0.84	1488	281	96.6	0.82	1787	251	96.5	0.83
FLSES 355 LAL	200	1488	374	96.7	0.84	1490	355	96.7	0.81	1791	317	96.6	0.82
FLSES 355 LB	250	1488	454	96.7	0.865	1491	428	96.8	0.84	1791	381	96.8	0.85
FLSES 355 LB	280	1488	512	96.7	0.86	1489	479	96.8	0.84	1789	427	96.8	0.85
FLSES 355 LC	315	1489	562	96.7	0.88	1489	526	96.8	0.86	1788	469	96.8	0.87
FLSES 355 LD	355	1490	634	96.7	0.88	1494	580	96.8	0.88	1793	523	96.8	0.88

IP55 CAST IRON MOTORS

Electro_Motor.ir

Type	400V 50Hz				Rated torque M_n at S1 continuous duty					Speed mechanical maximum
	Rated power	Rated speed	Rated current	Power factor	10Hz	17Hz	25Hz	50Hz	60Hz	
	P_n kW	N_n min ⁻¹	I_n A	Cos ϕ 4/4	N.m	N.m	N.m	N.m	N.m	
2 poles										
FLSES 280 M	75	2977	137	0.91	241	241	241	241	200	3600
FLSES 315 S	90	2982	166	0.90	288	288	288	288	226	3600
FLSES 315 M	110	2984	212	0.90	352	352	352	352	292	3600
FLSES 315 LA	132	2983	240	0.90	423	423	423	423	350	3600
FLSES 315 LA	160	2972	293	0.89	467	490	514	514	424	3600
FLSES 315 LB	200	2973	365	0.90	575	600	642	642	530	3600
FLSES 355 LB	250	2988	460	0.87	799	799	799	799	665	3600
FLSES 355 LB	315	2982	580	0.88	850	930	1009	1009	840	3600
FLSES 355 LC	355	2981	630	0.88	1000	1070	1137	1137	950	3600
4 poles										
FLSES 315 S	75	1490	142	0.83	450	465	481	481	401	2610
FLSES 315 S	90	1488	173	0.84	577	577	577	577	481	2610
FLSES 315 M	110	1487	212	0.85	706	706	706	706	588	2610
FLSES 315 LA	132	1487	260	0.87	840	870	884	884	737	2610
FLSES 315 LB	160	1487	316	0.84	900	950	1028	1028	857	2610
FLSES 355 LAL	200	1491	381	0.84	1281	1281	1281	1281	1068	2610
FLSES 355 LB	250	1490	460	0.87	1500	1602	1602	1602	1335	2610
FLSES 355 LB	280	1491	531	0.86	1650	1703	1793	1793	1040	2610
FLSES 355 LC	315	1488	570	0.88	1620	1825	2022	2022	1685	2610
FLSES 355 LD	355	1493	635	0.88	2000	2100	2271	2271	1893	2610

Summary of recommended protection devices

Mains voltage	Cable length	Frame size	Winding protection	Insulated bearings
≤ 480 V	< 20 m	All frame sizes	Standard	No
	> 20 m and < 100 m	≤ 315	Standard	No
		≥ 315	RIS or drive filter	NDE
> 480 V and ≤ 690 V	< 20 m	< 250	Standard	No
		≥ 250	RIS or drive filter	NDE
	> 20 m and < 100 m	≤ 250	RIS or drive filter	NDE
		≥ 250	RIS or drive filter	NDE (or DE+NDE if no filter for ≥ 315)

RIS: Reinforced Insulation System.

The filter is recommended above frame size 315.

Standard insulation = 1500 V peak and 3500 V/μs.

Protection solutions exist (insulation for winding and bearings).

For different cable length(s) and/or voltage(s), please consult Leroy-Somer.

**DESCRIPTIVE TABLE OF TERMINAL BOXES FOR 400 V RATED SUPPLY VOLTAGE
(in accordance with EN 50262)**

Series	Type	No. of poles	Terminal box material	Power + auxiliaries	
				Number of drill holes	Drill hole diameter*
FLSES	80	2 ; 4	Cast iron	1 (2 if auxiliaries)	ISO M20 X 1.5
	90	2; 4; 6			
	100	2; 4; 6			
	112	2; 4; 6			
	132	2; 4; 6			
	160	2; 4; 6			
	180	2; 4; 6		2	ISO M25 X 1.5
	200	2; 4; 6			
	225	2; 4; 6			
	250	2; 4; 6			
	280	2; 4; 6			
	315	2; 4; 6			
	355/400/450	2; 4; 6			

* As an option, both ISO M25 cable glands may be replaced by 1 ISO x M25 and 1 ISO x M32 (to comply with standard DIN 42925).

**TERMINAL BLOCKS
DIRECTION OF ROTATION**

Standard motors are fitted with a block of 6 terminals complying with standard NFC 51 120, with the terminal markings complying with IEC 60034-8 (or NF EN 60034-8).

When the motor is running in U1, V1, W1 or 1U, 1V, 1W from a direct mains supply L1, L2, L3, it turns clockwise when seen from the drive shaft end.

If any two of the phases are changed over, the motor will run in an anticlockwise direction (make sure that the motor has been designed to run in both directions).

If the motor is fitted with accessories (thermal protection or space heater), these must be connected on screw dominos with labelled wires.

Tightening torque for the nuts on the terminal blocks

Terminal	M5	M6	M8	M10	M12	M14	M16
Torque N.m	2.5	4	10	20	35	50	65

Series	Type	230/400V connections		400/690V connections
		No. of poles	Terminals	Terminals
FLSES	80 to 112	2 ; 4 ; 6	M5	M5
	132 S to 160	2 ; 4 ; 6	M6	M6
	180 L	6	M6	M6
	180 M	4	M8	M6
	180 LUR	6	M6	M6
	180 MUR	2 ; 4	M8	M6
	200 LU	2 (30 kW) ; 4 ; 6 2 (37 kW)	M8	M8
			M10	M8
	225 M	4 6	M10	M8
			M8	
	225 to 250	2 4	M10	M8
				M10
	250 M	6	M8	M8
	280 to 315	2 ; 4 ; 6	M12	M12
	355 L	2 ; 4 ; 6	M12	M12
	355 LK	4 ; 6	M14	M14
	355 LKB	2 4	M14	M14
				M14
	355 LKC	6	M14	M14
	400 LB	2 ; 4	M14	M14
	450 LA	4 ; 6	M14	M14
	450 LB	4 ; 6	M14	M14
450 LC	6	M14	M14	
450 LD	4	M14	M14	

IP55 CAST IRON MOTORS

IMfinity® 3-phase induction motors - IE2 - IE3 - IE4 - Non IE Efficiency

IP55 Cast iron frame

Dimensions

Shaft extensions

Dimensions in millimetres

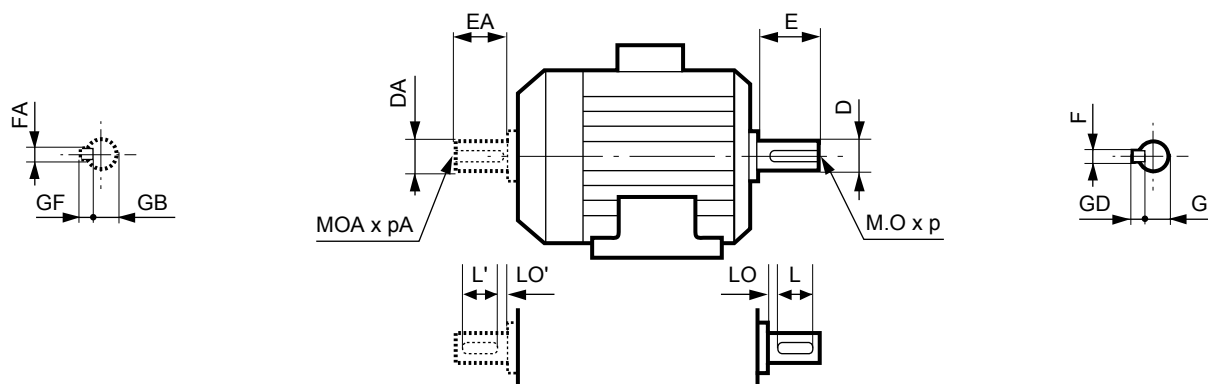

Type	Main shaft extensions																	
	4 and 6 poles									2 poles								
	F	GD	D	G	E	O	p	L	LO	F	GD	D	G	E	O	p	L	LO
FLSES 80 L/LG	6	6	19j6	15.5	40	M6	16	30	6	6	6	19j6	15.5	40	M6	16	30	6
FLSES 90 L/LU/SL	8	7	24j6	20	50	M8	19	40	6	8	7	24j6	20	50	M8	19	40	6
FLSES 100 L/LG/LR	8	7	28j6	24	60	M10	22	50	6	8	7	28j6	24	60	M10	22	50	6
FLSES 112 MG/MU	8	7	28j6	24	60	M10	22	50	6	8	7	28j6	24	60	M10	22	50	6
FLSES 132 M/MR/MU/SM	10	8	38k6	33	80	M12	28	63	10	10	8	38k6	33	80	M12	28	63	10
FLSES 160 L/LUR/M/MU	12	8	42k6	37	110	M16	36	90	20	12	8	42k6	37	110	M16	36	90	20
FLSES 180 L/LUR/M/MT/MUR	14	9	48k6	42.5	110	M16	36	90	20	14	9	48k6	42.5	110	M16	36	90	20
FLSES 200 LU	16	10	55m6	49	110	M20	42	90	20	16	10	55m6	49	110	M20	42	90	20
FLSES 225 MR	-	-	-	-	-	-	-	-	-	16	10	55m6	49	110	M20	42	90	20
FLSES 225 M/S/SR	18	11	60m6	53	140	M20	42	125	15	-	-	-	-	-	-	-	-	-
FLSES 250 M	18	11	65m6	58	140	M20	42	125	15	18	11	60m6	53	140	M20	42	125	15
FLSES 250 MR	18	11	65m6	58	140	M20	42	125	15	-	-	-	-	-	-	-	-	-
FLSES 280 M/S	20	12	75m6	67.5	140	M20	42	125	15	18	11	65m6	58	140	M20	42	125	15
FLSES 315 LA/LB	25	14	90m6	81	170	M24	50	140	30	20	12	70m6	62.5	140	M20	42	125	15
FLSES 315 M/S	22	14	80m6	71	170	M20	42	140	30	18	11	65m6	58	140	M20	42	125	15
FLSES 355 LA/LAL/LB/LC/LD/LKB	28	16	100m6	90	210	M24	50	180	30	22	14	80m6	71	170	M20	42	140	30
FLSES 355 LKA/LKC	28	16	100m6	90	210	M24	50	180	30	-	-	-	-	-	-	-	-	-
FLSES 400 LB	28	16	110m6	100	210	M24	50	180	30	22	14	80m6	71	170	M20	42	140	30
FLSES 450 LA/LB/LC/LD	32	18	120m6	109	210	M24	50	180	30	-	-	-	-	-	-	-	-	-

Type	Secondary shaft extensions																	
	4 and 6 poles									2 poles								
	FA	GF	DA	GB	EA	OA	pA	L'	LO'	FA	GF	DA	GB	EA	OA	pA	L'	LO'
FLSES 80 L	5	5	14j6	11	30	M5	15	25	3.5	5	5	14j6	11	30	M5	15	25	3.5
FLSES 80 LG	6	6	19j6	15.5	40	M6	16	30	6	6	6	19j6	15.5	40	M6	16	30	6
FLSES 90 L/LU/SL	6	6	19j6	15.5	40	M6	16	30	6	6	6	19j6	15.5	40	M6	16	30	6
FLSES 100 L/LG/LR	8	7	24j6	20	50	M8	19	40	6	8	7	24j6	20	50	M8	19	40	6
FLSES 112 MG/MU	8	7	24j6	20	50	M8	19	40	6	8	7	24j6	20	50	M8	19	40	6
FLSES 132 M/MR/MU/SM	8	7	28k6	24	60	M10	22	50	6	8	7	28k6	24	60	M10	22	50	6
FLSES 160 L/M/MU	12	8	42k6	37	110	M16	36	100	6	12	8	42k6	37	110	M16	36	100	6
FLSES 160LUR	12	8	42k6	37	110	M16	36	90	20	12	8	42k6	37	110	M16	36	90	20
FLSES 180 MT/MUR	14	9	48k6	42.5	110	M16	36	90	20	14	9	48k6	42.5	110	M16	36	90	20
FLSES 180 L/LUR/M	14	9	48k6	42.5	110	M16	36	98	12	14	9	48k6	42.5	110	M16	36	98	12
FLSES 200 LU	16	10	55m6	49	110	M20	42	90	20	16	10	55m6	49	110	M20	42	90	20
FLSES 225 M/S/SR	18	11	60m6	53	140	M20	42	125	15	16	10	55m6	49	110	M20	42	90	20
FLSES 225 MR	-	-	-	-	-	-	-	-	-	16	10	55m6	49	110	M20	42	90	20
FLSES 250 M/MR	18	11	60m6	53	140	M20	42	125	15	18	11	60m6	53	140	M20	42	125	15
FLSES 280 M/S	20	12	60m6	53	140	M20	42	125	15	18	11	60m6	53	140	M20	42	125	15
FLSES 315 LA/LB	25	14	90m6	81	170	M24	50	140	30	20	12	70m6	63.5	140	M20	42	125	15
FLSES 315 M/S	22	14	80m6	71	170	M20	42	140	30	18	11	65m6	58	140	M20	42	125	15
FLSES 355 LA/LAL/LB/LC/LD/LKA/LKB/LKC	28	16	100m6	90	210	M24	50	180	30	22	14	80m6	71	170	M20	42	140	30
FLSES 400 LB	28	16	110m6	100	210	M24	50	180	30	22	14	80m6	71	170	M20	42	140	30
FLSES 450 LA/LB/LC/LD	32	18	120m6	109	210	M24	50	180	30	-	-	-	-	-	-	-	-	-

Electro_Motor.ir

IP55 CAST IRON MOTORS

IMfinity® 3-phase induction motors - IE2 - IE3 - IE4 - Non IE Efficiency

IP55 Cast iron frame

Dimensions

Foot mounted IM 1001 (IM B3)

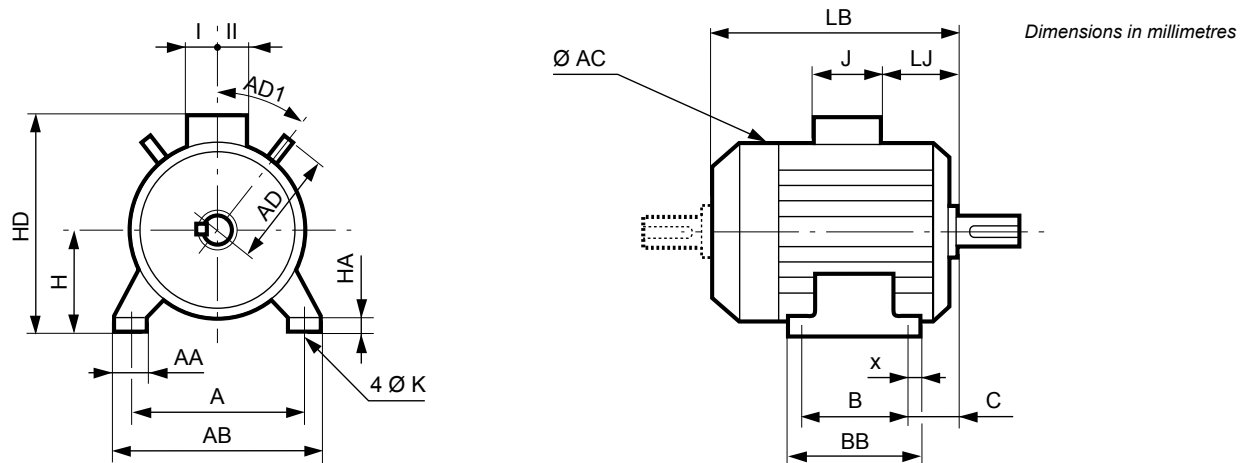

Type	Main dimensions																		
	A	AB	B	BB	C	x	AA	K	HA	H	AC*	HD	LB	LJ	J	I	II	AD	AD1
FLSES 80L	125	157	100	130	50	18	34	10	10	80	170	228	212	7	136	68	68	-	-
FLSES 80LG	125	170	100	138	50	22	39	10	10	80	203	238	243	8	136	68	68	135	41
FLSES 90L	140	170	125	162	56	28	33	10	10	90	203	248	239	8.5	136	68	68	135	41
FLSES 90LU	140	170	125	162	56	28	33	10	10	90	203	248	266	8.5	136	68	68	135	41
FLSES 90SL	140	170	125	162	56	28	33	10	10	90	203	248	239	8.5	136	68	68	135	41
FLSES 100L	160	196	140	185	63	29	40	12	13	100	204	258	300	8	136	68	68	135	41
FLSES 100LG	160	196	140	168	63	13	40	12	14	100	227	264	299	0.5	136	68	68	130	45
FLSES 100LR	160	196	140	185	63	29	40	12	13	100	204	258	300	8	136	68	68	135	41
FLSES 112MG	190	230	140	186	60	32	48	12	12	112	230	294	299	8	136	68	68	148	41
FLSES 112MU	190	230	140	186	60	32	48	12	12	112	230	294	299	8	136	68	68	148	41
FLSES 132M	216	255	178	240	89	50	63	12	16	132	270	335	385	22	136	68	68	165	37.5
FLSES 132MR	216	255	178	240	89	50	63	12	16	132	270	335	447	22	136	68	68	165	37.5
FLSES 132MU	216	255	178	240	89	50	63	12	16	132	270	335	447	22	136	68	68	165	37.5
FLSES 132SM	216	255	140	240	89	50	63	12	16	132	270	335	385	22	136	68	68	165	37.5
FLSES 160L	254	294	254	294	108	20	65	14.5	20	160	315	436	495	30	246	126	148	179	45
FLSES 160LUR	254	294	254	294	108	20	65	14.5	20	160	315	436	510	30	246	126	148	179	45
FLSES 160M	254	294	210	294	108	20	65	14.5	20	160	315	436	495	30	246	126	148	179	45
FLSES 160MU	254	294	210	294	108	20	65	14.5	20	160	315	436	510	30	246	126	148	179	45
FLSES 180L	279	330	279	330	121	28	70	14.5	28	180	353	477	552	42	246	126	148	190	45
FLSES 180M	279	330	279	330	121	28	70	14.5	28	180	353	477	593	42	246	126	148	190	45
FLSES 180MT	279	330	241	330	121	28	70	14.5	28	180	353	477	552	42	246	126	148	190	45
FLSES 180LUR	279	330	241	330	115	28	70	14.5	28	180	353	477	537	36	246	126	148	190	45
FLSES 180MUR	279	324	241	290	121	25	80	14.5	25	180	315	456	545	30	246	126	148	179	45
FLSES 200LU	318	374	305	360	135	28	60	18.5	17	200	396	528	674	51	246	126	148	243	45
FLSES 225M	356	426	311	375	149	32	80	18.5	27	225	487	652	779	69.5	352	175	212	276	45
FLSES 225MR	356	426	311	375	144.5	32	70	18.5	17	225	398	553	674	51	246	126	148	243	45
FLSES 225S	356	426	286	375	149	32	80	18.5	27	225	487	652	779	69.5	352	175	212	276	45
FLSES 225SR	356	426	286	375	144.5	32	70	18.5	17	225	398	553	674	51	246	126	148	243	45
FLSES 250M	406	476	349	413	168	32	80	24	27	250	487	677	779	69.5	352	175	212	276	45
FLSES 250MR	406	476	349	413	168	32	80	24	27	250	487	677	859	69.5	352	175	212	276	45
FLSES 280M	457	527	419	486	190	33	80	24	30.5	280	475	719	959	69.5	352	175	212	305	45
FLSES 280S	457	527	368	486	190	33	80	24	30.5	280	475	719	959	69.5	352	175	212	305	45
FLSES 315LA	508	600	508	610	216	58	100	28	35	315	600	847	1177	101	452	219	269	343	45
FLSES 315LB	508	600	508	610	216	58	100	28	35	315	600	847	1177	101	452	219	269	343	45
FLSES 315M	508	600	457	610	216	58	100	28	35	315	600	847	1177	101	452	219	269	343	45
FLSES 315S	508	600	406	610	216	58	100	28	35	315	600	847	1177	101	452	219	269	343	45
FLSES 355LA	610	710	630	756	254	76	100	28	35	355	688	925	1303	121	452	219	269	-	-
FLSES 355LAL	610	710	630	756	254	76	100	28	35	355	688	925	1303	121	452	219	269	-	-
FLSES 355LB	610	710	630	756	254	76	100	28	35	355	688	925	1303	121	452	219	269	-	-
FLSES 355LC	610	710	630	756	254	76	100	28	35	355	688	925	1303	121	452	219	269	-	-
FLSES 355LD	610	710	630	756	254	76	100	28	35	355	688	925	1303	121	452	219	269	-	-
FLSES 355LKA	610	750	630	815	254	40	128	27	45	355	787	1117	1702	52	700	224	396	-	-
FLSES 355LKB	610	750	630	815	254	40	128	27	45	355	787	1117	1702	52	700	224	396	-	-
FLSES 355LKC	610	750	630	815	254	40	128	27	45	355	787	1117	1702	52	700	224	396	-	-
FLSES 400LB	686	800	710	815	280	65	128	35	45	400	787	1162	1702	52	700	224	396	-	-
FLSES 450LA	750	890	800	950	315	94	140	35	45	450	877	1260	1738	68	700	224	396	-	-
FLSES 450LB	750	890	800	950	315	94	140	35	45	450	877	1260	1738	68	700	224	396	-	-
FLSES 450LC	750	890	1000	1170	315	94	140	35	45	450	877	1260	2088	68	700	224	396	-	-
FLSES 450LD	750	890	1000	1170	315	94	140	35	45	450	877	1260	2088	68	700	224	396	-	-

* AC: housing diameter without lifting rings

Electro_Motor.ir

IP55 CAST IRON MOTORS

IMfinity® 3-phase induction motors - IE2 - IE3 - IE4 - Non IE Efficiency

IP55 Cast iron frame

Dimensions

Foot and flange mounted IM 2001 (IM B35)

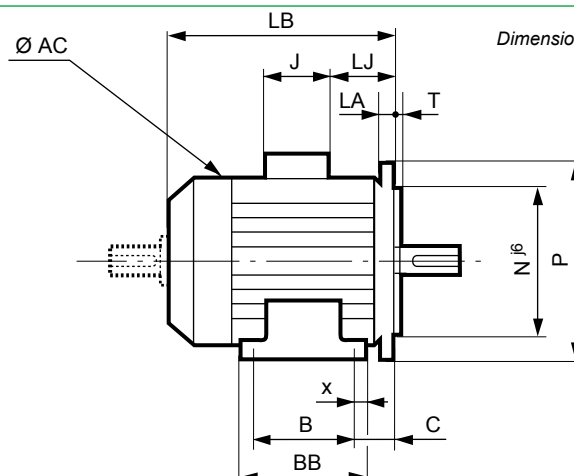
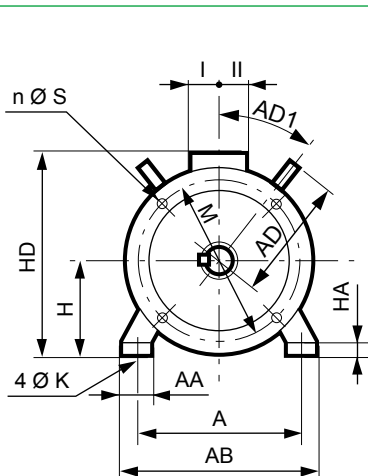

Dimensions in millimetres

Type	Main dimensions																Symb			
	A	AB	B	BB	C	x	AA	K	HA	H	AC*	HD	LB	LJ	J	I		II	AD	AD1
FLSES 80L	125	157	100	130	50	18	34	10	10	80	170	228	212	7	136	68	68	-	-	FF165
FLSES 80LG	125	170	100	138	70	22	39	10	10	80	203	238	263	28	136	68	68	135	41	FF165
FLSES 90L	140	170	125	162	76	28	33	10	10	90	203	248	259	28.5	136	68	68	135	41	FF165
FLSES 90LU	140	170	125	162	76	28	33	10	10	90	203	248	259	28.5	136	68	68	135	41	FF165
FLSES 90SL	140	170	125	162	76	28	33	10	10	90	203	248	259	28.5	136	68	68	135	41	FF165
FLSES 100L	160	196	140	185	63	29	40	12	13	100	204	258	300	8	136	68	68	135	41	FF215
FLSES 100LG	160	196	140	185	73	13	40	12	14	100	227	264	309	9.5	136	68	68	130	45	FF215
FLSES 100LR	160	196	140	185	63	29	40	12	13	100	204	258	300	8	136	68	68	135	41	FF215
FLSES 112MG	190	230	140	186	70	32	48	12	12	112	230	294	309	18	136	68	68	148	41	FF215
FLSES 112MU	190	230	140	186	70	32	48	12	12	112	230	294	309	18	136	68	68	148	41	FF215
FLSES 132M	216	255	178	240	89	50	63	12	16	132	270	335	385	22	136	68	68	165	37.5	FF265
FLSES 132MR	216	255	178	240	89	50	63	12	16	132	270	335	447	22	136	68	68	165	37.5	FF265
FLSES 132MU	216	255	178	240	89	50	63	12	16	132	270	335	447	22	136	68	68	165	37.5	FF265
FLSES 132SM	216	255	140	240	89	50	63	12	16	132	270	335	385	22	136	68	68	165	37.5	FF265
FLSES 160L	254	294	254	294	108	20	65	14.5	20	160	315	436	495	30	246	126	148	179	45	FF300
FLSES 160LUR	254	294	254	294	108	20	65	14.5	20	160	315	436	510	30	246	126	148	179	45	FF300
FLSES 160M	254	294	210	294	108	20	65	14.5	20	160	315	436	495	30	246	126	148	179	45	FF300
FLSES 160MU	254	294	210	294	108	20	65	14.5	20	160	315	436	510	30	246	126	148	179	45	FF300
FLSES 180L	279	330	279	330	121	28	70	14.5	28	180	353	477	552	42	246	126	148	190	45	FF300
FLSES 180M	279	330	241	330	121	28	70	14.5	28	180	353	477	552	42	246	126	148	190	45	FF300
FLSES 180MT	279	330	241	330	115	28	70	14.5	28	180	353	477	537	36	246	126	148	190	45	FF300
FLSES 180LUR	279	330	279	330	121	28	70	14.5	28	180	353	477	593	42	246	126	148	190	45	FF300
FLSES 180MUR	279	324	241	290	121	25	80	14.5	25	180	315	456	545	30	246	126	148	179	45	FF300
FLSES 200LU	318	374	305	360	135	28	60	18.5	17	200	396	528	674	51	246	126	148	243	45	FF350
FLSES 225M	356	426	311	375	149	32	80	18.5	27	225	487	652	779	69.5	352	175	212	276	45	FF400
FLSES 225MR	356	426	311	375	144.5	32	70	18.5	17	225	398	553	674	51	246	126	148	243	45	FF400
FLSES 225S	356	426	286	375	149	32	80	18.5	27	225	487	652	779	69.5	352	175	212	276	45	FF400
FLSES 225SR	356	426	286	375	144.5	32	70	18.5	17	225	398	553	674	51	246	126	148	243	45	FF400
FLSES 250M	406	476	349	413	168	32	80	24	27	250	487	677	779	69.5	352	175	212	276	45	FF500
FLSES 250MR	406	476	349	413	168	32	80	24	27	250	487	677	859	69.5	352	175	212	276	45	FF500
FLSES 280M	457	527	419	486	190	33	80	24	30.5	280	475	719	959	69.5	352	175	212	305	45	FF500
FLSES 280S	457	527	368	486	190	33	80	24	30.5	280	475	719	959	69.5	352	175	212	305	45	FF500
FLSES 315LA	508	600	508	610	216	58	100	28	35	315	600	847	1177	101	452	219	269	343	45	FF600
FLSES 315LB	508	600	508	610	216	58	100	28	35	315	600	847	1177	101	452	219	269	343	45	FF600
FLSES 315M	508	600	457	610	216	58	100	28	35	315	600	847	1177	101	452	219	269	343	45	FF600
FLSES 315S	508	600	406	610	216	58	100	28	35	315	600	847	1177	101	452	219	269	343	45	FF600
FLSES 355LA	610	710	630	756	254	76	100	28	35	355	688	925	1303	121	452	219	269	-	-	FF740
FLSES 355LAL	610	710	630	756	254	76	100	28	35	355	688	925	1303	121	452	219	269	-	-	FF740
FLSES 355LB	610	710	630	756	254	76	100	28	35	355	688	925	1303	121	452	219	269	-	-	FF740
FLSES 355LC	610	710	630	756	254	76	100	28	35	355	688	925	1303	121	452	219	269	-	-	FF740
FLSES 355LD	610	710	630	756	254	76	100	28	35	355	688	925	1303	121	452	219	269	-	-	FF740
FLSES 355LKA	610	750	630	815	254	40	128	27	45	355	787	1117	1702	52	700	224	396	-	-	FF740
FLSES 355LKB	610	750	630	815	254	40	128	27	45	355	787	1117	1702	52	700	224	396	-	-	FF740
FLSES 355LKC	610	750	630	815	254	40	128	27	45	355	787	1117	1702	52	700	224	396	-	-	FF740
FLSES 400LB	686	800	710	815	280	65	128	35	45	400	787	1162	1702	52	700	224	396	-	-	FF940
FLSES 450LA	750	890	800	950	315	94	140	35	45	450	877	1260	1738	68	700	224	396	-	-	FF1080
FLSES 450LB	750	890	800	950	315	94	140	35	45	450	877	1260	1738	68	700	224	396	-	-	FF1080
FLSES 450LC	750	890	1000	1170	315	94	140	35	45	450	877	1260	2088	68	700	224	396	-	-	FF1080
FLSES 450LD	750	890	1000	1170	315	94	140	35	45	450	877	1260	2088	68	700	224	396	-	-	FF1080

* AC: housing diameter without lifting rings

Electro_Motor.ir

IP55 CAST IRON MOTORS

IMfinity® 3-phase induction motors - IE2 - IE3 - IE4 - Non IE Efficiency
 IP55 Cast iron frame
Dimensions
 Foot and face mounted IM 2101 (IM B34)

Dimensions in millimetres

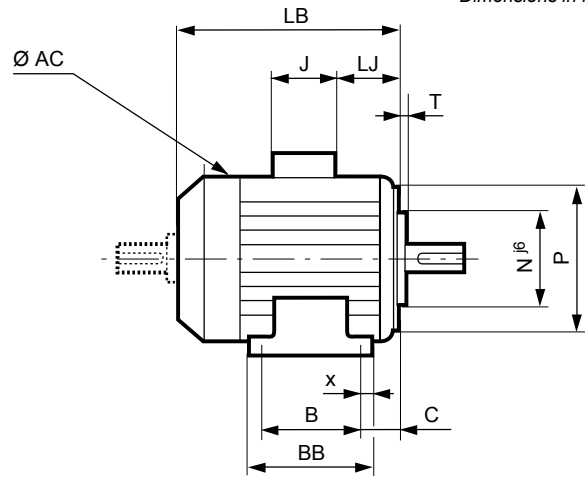
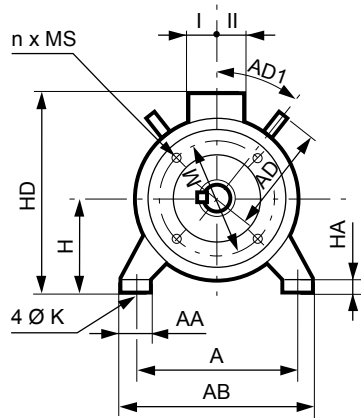

Type	Main dimensions																			
	A	AB	B	BB	C	x	AA	K	HA	H	AC*	HD	LB	LJ	J	I	II	AD	AD1	Symb
FLSES 80L	125	157	100	130	50	18	34	10	10	80	170	228	212	7	136	68	68	-	-	FT100
FLSES 80LG	125	170	100	138	50	22	39	10	10	80	203	238	243	8	136	68	68	135	41	FT100
FLSES 90L	140	170	125	162	56	28	33	10	10	90	203	248	239	8.5	136	68	68	135	41	FT115
FLSES 90LU	140	170	125	162	56	28	33	10	10	90	203	248	266	8.5	136	68	68	135	41	FT115
FLSES 90SL	140	170	125	162	56	28	33	10	10	90	203	248	239	8.5	136	68	68	135	41	FT115
FLSES 100L	160	196	140	185	63	29	40	12	13	100	204	258	300	8	136	68	68	135	41	FT130
FLSES 100LG	160	196	140	168	73	13	40	12	14	100	227	264	309	9.5	136	68	68	130	45	FT130
FLSES 100LR	160	196	140	185	63	29	40	12	13	100	204	258	300	8	136	68	68	135	41	FT130
FLSES 112MG	190	230	140	186	70	32	48	12	12	112	230	294	309	18	136	68	68	148	41	FT130
FLSES 112MU	190	230	140	186	70	32	48	12	12	112	230	294	309	18	136	68	68	148	41	FT130
FLSES 132M	216	255	178	240	89	50	63	12	16	132	270	335	385	22	136	68	68	165	37.5	FT165
FLSES 132MR	216	255	178	240	89	50	63	12	16	132	270	335	447	22	136	68	68	165	37.5	FT165
FLSES 132MU	216	255	178	240	89	50	63	12	16	132	270	335	447	22	136	68	68	165	37.5	FT165
FLSES 132SM	216	255	140	240	89	50	63	12	16	132	270	335	385	22	136	68	68	165	37.5	FT165

* AC: housing diameter without lifting rings

IP55 CAST IRON MOTORS

Electro_Motor.ir

IMfinity® 3-phase induction motors - IE2 - IE3 - IE4 - Non IE Efficiency

IP55 Cast iron frame

Dimensions

Face mounted IM 3601 (IM B14)

Dimensions in millimetres

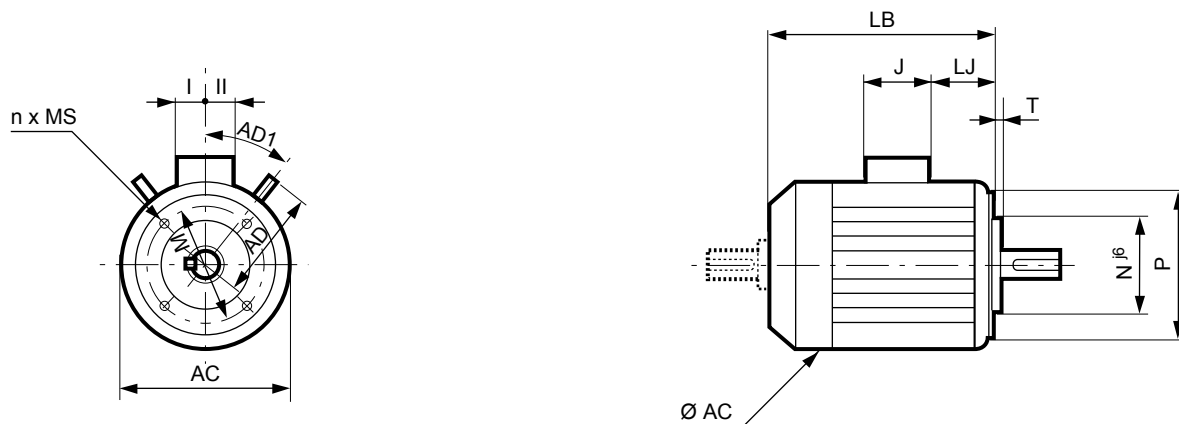

Type	Main dimensions								
	AC*	LB	HJ	LJ	J	I	II	AD	AD1
FLSES 80L	170	212	148	7	136	68	68	-	-
FLSES 80LG	203	243	158	8	136	68	68	135	41
FLSES 90L	203	239	158	8.5	136	68	68	135	41
FLSES 90LU	203	266	158	8.5	136	68	68	135	41
FLSES 90SL	203	239	158	8.5	136	68	68	135	41
FLSES 100L	204	300	158	8	136	68	68	135	41
FLSES 100LG	227	309	164	9.5	136	68	68	130	45
FLSES 100LR	204	300	158	8	136	68	68	135	41
FLSES 112MG	230	309	182	18	136	68	68	148	41
FLSES 112MU	230	309	182	18	136	68	68	148	41
FLSES 132M	270	385	203	22	136	68	68	165	37.5
FLSES 132MR	270	447	203	22	136	68	68	165	37.5
FLSES 132MU	270	447	203	22	136	68	68	165	37.5
FLSES 132SM	270	385	203	22	136	68	68	165	37.5

* AC: housing diameter without lifting rings

IEC symbol	Faceplate dimensions						
	M	N	P	T	n	α°	S
FT100	100	80	120	3	4	45	M6
FT100	100	80	120	3	4	45	M6
FT115	115	95	140	3	4	45	M8
FT115	115	95	140	3	4	45	M8
FT115	115	95	140	3	4	45	M8
FT130	130	110	160	3.5	4	45	M8
FT130	130	110	160	3.5	4	45	M8
FT130	130	110	160	3.5	4	45	M8
FT130	130	110	160	3.5	4	45	M8
FT130	130	110	160	3.5	4	45	M8
FT165	165	130	200	3.5	4	45	M10
FT165	165	130	200	3.5	4	45	M10
FT165	165	130	200	3.5	4	45	M10
FT165	165	130	200	3.5	4	45	M10

IP55 CAST IRON MOTORS

Electro_Motor.ir

PERMANENTLY GREASED BEARINGS

Under normal operating conditions, the service life in hours of the bearing is indicated in the table below for ambient temperatures less than 55°C.

Series	Type	No. of poles	Types of permanently greased bearing		Bearing life according to speed of rotation								
					3000 min ⁻¹			1500 min ⁻¹			1000 min ⁻¹		
					25°C	40°C	55°C	25°C	40°C	55°C	25°C	40°C	55°C
FLSES	80 L	2	6203 C3	6204 C3	≥40000	≥40000	25000	-	-	-	-	-	-
	80 LG	4	6204 C3	6205 C3	-	-	-	≥40000	≥40000	31000	-	-	-
	90 SL/L	2;4 ;6			≥40000	≥40000	24000	-	-	-	≥40000	≥40000	34000
	90 LU	2;6	6205 C3	6205 C3	≥40000	≥40000	24000	-	-	-	≥40000	≥40000	34000
	100 L	2;4	6205 C3	6206 C3	≥40000	≥40000	22000	≥40000	≥40000	30000	-	-	-
	100 LG	4;6			-	-	-	-	-	-	≥40000	≥40000	33000
	112 MG	2;6			≥40000	≥40000	22000	-	-	-	-	-	-
	112 MU	4	6206 C3	6206 C3	-	-	-	≥40000	≥40000	30000	-	-	-
	132 SM/M	2;4;6	6207 C3	6308 C3	≥40000	≥40000	19000	≥40000	≥40000	25000	≥40000	≥40000	30000
	132 MU	2;4	6307 C3	6308 C3	≥40000	≥40000	19000	≥40000	≥40000	25000	-	-	-
	132 MR	4;6	6308 C3	6308 C3	-	-	-	≥40000	≥40000	25000	≥40000	≥40000	30000
	160 M	2;4;6	6210 C3	6309 C3	≥40000	37800	18900	≥40000	≥40000	36900	≥40000	≥40000	20050
	160 MU	6			-	-	-	-	-	-	-	-	
	160 LUR	2;4 ;6	6210 C3	6310 C3	≥40000	24500	12250	≥40000	36400	18200	≥40000	≥40000	22450
	180 M	2	6212 C3	6310 C3	34000	17000	8500	-	-	-	-	-	-
	180 MT	4	6210 C3	6310 C3	-	-	-	≥40000	35500	17750	-	-	-
	180 MUR	2	6312 C3	6310 C3	≥40000	22800	11400	-	-	-	-	-	-
	180 L	4;6	6212 C3	6310 C3	-	-	-	≥40000	39500	19750	≥40000	≥40000	29050
	180 LUR	4;6	6312 C3	6310 C3	-	-	-	≥40000	≥40000	22900	≥40000	≥40000	29900
	200 LU	2;4;6	6312 C3	6312 C3	28600	14300	7150	≥40000	25400	12700	≥40000	33200	16600
225 S	4	6314 C3	6314 C3	-	-	-	≥40000	23700	11850	-	-	-	
225 SR	4	6312 C3	6313 C3	-	-	-	≥40000	≥40000	21500	-	-	-	
225 M	4;6	6314 C3	6314 C3	-	-	-	≥40000	23700	11850	≥40000	25600	12800	
225 MR	2	6312 C3	6313 C3	≥40000	22800	11400	-	-	-	-	-	-	

IP55 CAST IRON MOTORS

BEARINGS WITH GREASE NIPPLES

The chart opposite shows the greasing intervals, depending on the type of motor, for standard bearing assemblies of frame size ≥ 160 mm fitted with grease nipples, operating at an ambient temperature of 25°C, 40°C and 55°C on a horizontal shaft machine.

SPECIAL CONSTRUCTION AND ENVIRONMENT

For vertical shaft machines, the greasing intervals will be approximately 80% of the values stated in the table below.

Note: The quality and quantity of grease and the greasing interval are shown on the machine nameplate.

For special assemblies (motors fitted with DE roller bearings or other types), machines of frame size ≥ 160 mm have bearings with grease nipples.

Instructions for bearing maintenance are given on the nameplates on these machines.

The chart below is valid for FLSES motors lubricated with Polyrex EM103 grease which is used as standard.

Series	Type	No. of poles	Type of bearing for bearings with grease nipples		Quantity of grease g	Greasing intervals in hours								
			N.D.E.	D.E.		3000 min ⁻¹			1500 min ⁻¹			1000 min ⁻¹		
						25°C	40°C	55°C	25°C	40°C	55°C	25°C	40°C	55°C
FLSES	160 M*	2; 4; 6	6210 C3	6309 C3	13	22200	11100	5550	32400	16200	8100	39800	19900	9950
	160 MU	6				-	-	-	-	-	-	23400	11700	5850
	160 LUR*	2; 4; 6	6210 C3	6310 C3	15	19600	9800	4900	30400	15200	7600	38200	19100	6600
	180 M*	2	6212 C3	6310 C3	15	18000	9000	4500	-	-	-	-	-	-
	180 MT*	4	6210 C3	6310 C3	15	-	-	-	30400	15200	7600	-	-	-
	180 MUR*	2	6312 C3	6310 C3	15	10600	5300	2650	-	-	-	-	-	-
	180 L*	4; 6	6212 C3	6310 C3	20	-	-	-	29200	14600	7300	37200	18600	9300
	180 LUR*	4; 6	6312 C3	6310 C3	20	-	-	-	26800	13400	6700	35000	17500	8750
	200 LU*	2; 4; 6	6312 C3	6312 C3	20	15200	7600	3800	26800	13400	6700	35000	17500	8750
	225 S*	4	6314 C3	6314 C3	25	-	-	-	23600	11800	5900	-	-	-
	225 SR*	4	6312 C3	6313 C3	25	-	-	-	25200	12600	6300	-	-	-
	225 M*	4; 6	6314 C3	6314 C3	25	-	-	-	23600	11800	5900	32200	16100	8050
	225 MR*	2	6312 C3	6313 C3	25	13400	6700	3350	-	-	-	-	-	-
	250 M	2; 6				10400	5200	2600	-	-	-	32200	16100	8050
	250 MR	4	6314 C3	6314 C3	25	-	-	-	17800	8900	4450	-	-	-
	280 S/M	2; 4; 6	6314 C3	6316 C3	35	7200	3600	1800	21000	13230	6615	29000	29000	18270
	315 S/M/L	2	6316 C3	6218 C3	35	7400	5880	2920	-	-	-	-	-	-
	315 S/M/L	4; 6	6316 C3	6320 C3	50	-	-	-	15600	12400	6160	25000	25000	12500
	355 LA/LB/LC/LD	2	6316 C3	6218 C3	35	7400	3700	1850	-	-	-	-	-	-
	355 LA/LB/LC/LD	4; 6	6316 C3	6322 C3	60	-	-	-	13200	8316	4160	22000	13860	6930
	355 LKB	4; 6	6324 C3	6324 C3	72	-	-	-	7500	3700	2800	20000	20000	10000
	355 LKB	2	6317 C4	6317 C4	37	6600	5200	2600	-	-	-	-	-	-
	355 LKC	6	6324 C3	6324 C3	72	-	-	-	-	-	-	20000	17000	8500
	400 LB	2	6317 C4	6317 C4	37	6600	5200	2600	-	-	-	-	-	-
	400 LB	4	6324 C3	6324 C3	72	-	-	-	7500	3700	2800	-	-	-
	450 LA	4	6328 C3	6328 C3	93	-	-	-	4600	2300	1100	-	-	-
450 LA	6	6328 C3	6328 C3	93	-	-	-	-	-	-	10000	6000	3000	
450 LB	4	6328 C3	6328 C3	93	-	-	-	4600	2300	1100	-	-	-	
450 LB	6	6328 C3	6328 C3	93	-	-	-	-	-	-	10000	6000	3000	
450 LC	6	6328 C3	6328 C3	93	-	-	-	-	-	-	10000	6000	3000	
450 LD	4	6328 C3	6328 C3	93	-	-	-	4600	2300	1100	-	-	-	

* bearing with grease nipples on request

STANDARD BEARING FITTING ARRANGEMENTS

FLSES series	Mounting arrangement	Horizontal shaft	Vertical shaft	
			Shaft facing down	Shaft facing up
Foot mounted motors	Mounting arrangement	B3	V5	V6
	standard mounting	DE bearing: - located at DE for frame ≤ 132 - locked for frame ≥ 160	DE bearing locked	DE bearing locked
Flange mounted motors (or foot and flange)	Mounting arrangement	B5 / B35 / B14 / B34	V1 / V15 / V18 / V58	V3 / V36 / V19 / V69
	standard mounting	DE bearing locked on frames 80 to 355LD NDE bearing locked on frames 355LKA to 450LD	DE bearing locked on frames 80 to 355LD NDE bearing locked on frames 355LKA to 450LD	DE bearing locked on frames 80 to 355LD NDE bearing locked on frames 355LKA to 450LD

IP55 CAST IRON MOTORS

HORIZONTAL MOTOR

For a bearing life L_{10h}
of 25,000 hours
and 40,000 hours



Series	Type	No. of poles	Permissible axial load (in daN) on main shaft extension for standard bearing assembly													
			3000 min ⁻¹						1500 min ⁻¹				1000 min ⁻¹			
			→		←		→		←		→		←			
			25,000 hours	40,000 hours	25,000 hours	40,000 hours	25,000 hours	40,000 hours	25,000 hours	40,000 hours	25,000 hours	40,000 hours	25,000 hours	40,000 hours		
	80 L	2	30	21	(60)	(51)	-	-	-	-	-	-	-	-		
	80 LG	2; 4	28	19	(68)	(59)	48	34	(88)	(74)	-	-	-	-		
	90 SL/L	2; 4; 6	29	23	(69)	(56)	45	32	(85)	(72)	56	40	(96)	(80)		
	90 LU	2; 4; 6	22	13	(72)	(63)	38	25	(88)	(75)	47	32	(97)	(82)		
	100 L	2; 4	40	26	(90)	(76)	61	43	(111)	(93)	-	-	-	-		
	100 LR	4	-	-	-	-	61	43	(111)	(93)	-	-	-	-		
	100 LG	4; 6	-	-	-	-	55	38	(105)	(88)	75	53	(125)	(103)		
	112 MG	2; 6	37	24	(87)	(74)	-	-	-	-	82	61	(132)	(111)		
	112 MU	4; 6	-	-	-	-	54	36	(114)	(96)	66	45	(126)	(105)		
	132 SM/M	2; 4; 6	101	74	(171)	(144)	146	109	(216)	(179)	182	138	(252)	(208)		
	132 MU	6	-	-	-	-	-	-	-	-	169	126	(249)	(206)		
	132 MR	4	-	-	-	-	129	93	(219)	(183)	-	-	-	-		
	160 M	2; 4	129	94	229	194	187	140	287	240	234	177	334	277		
	160 MU	6	-	-	-	-	-	-	-	-	219	164	319	264		
	160 L	2; 4	118	83	218	183	195	148	295	248	-	-	-	-		
	160 LUR	2; 4; 6	158	117	258	217	212	158	312	258	257	193	357	293		
	180 M	2; 4	189	148	237	196	228	174	291	237	-	-	-	-		
	180 MT	4	-	-	-	-	215	161	315	261	-	-	-	-		
	180 MUR	2	178	137	241	200	-	-	-	-	-	-	-	-		
	180 L	4; 6	-	-	-	-	240	186	288	234	272	208	320	256		
	180 LUR	4; 6	-	-	-	-	224	170	287	233	224	162	287	225		
FLSES	200 LU	2; 4; 6	249	196	312	259	316	245	379	308	327	245	390	308		
	225 S	4	-	-	-	-	427	336	490	399	-	-	-	-		
	225 SR	4	-	-	-	-	370	290	433	353	-	-	-	-		
	225 M	4; 6	-	-	-	-	416	325	496	405	511	402	591	482		
	225 MR	2	280	220	343	283	-	-	-	-	-	-	-	-		
	250 M	2; 6	308	240	388	320	-	-	-	-	506	400	506	400		
	250 MR	4	-	-	-	-	413	322	493	402	-	-	-	-		
	280 S/M	2; 4; 6	342	258	484	400	483	372	625	514	581	445	723	587		
	315 S/M/LA/LB	2; 6	411	348	165	102	-	-	-	-	933	761	687	515		
	315 S/M/LA/LB	4	-	-	-	-	814	670	568	424	-	-	-	-		
	355 LA/LB/LC/LD	2	393	333	147	87	-	-	-	-	-	-	-	-		
	355 LAL	4	-	-	-	-	876	724	630	478	-	-	-	-		
	355 LA/LB/LC/LD	4; 6	-	-	-	-	876	724	630	478	947	764	701	518		
	355 LKA	6	-	-	-	-	-	-	-	-	937	760	615	440		
	355 LKB	2	435	-	266	-	-	-	-	-	-	-	-	-		
	355 LKB	4	-	-	-	-	843	-	530	-	-	-	-	-		
	355 LKB	6	-	-	-	-	-	-	-	-	897	725	577	405		
	355 LKC	6	-	-	-	-	-	-	-	-	964	-	596	-		
	400 LB	2	435	-	266	-	-	-	-	-	-	-	-	-		
	400 LB	4	-	-	-	-	862	-	582	-	-	-	-	-		
	450 LA	4; 6	-	-	-	-	1061	-	707	-	1179	-	808	-		
	450 LB/LC/LD	4; 6	-	-	-	-	1041	-	687	-	1162	-	941	-		

(): axial loads permissible with DE bearing locked

**VERTICAL MOTOR
SHAFT FACING DOWN**

For a bearing life L_{10h}
of 25,000 hours
and 40,000 hours



Series	Type	No. of poles	Permissible axial load (in daN) on main shaft extension for standard bearing assembly											
			3000 min ⁻¹				1500 min ⁻¹				1000 min ⁻¹			
			25,000 hours	40,000 hours	25,000 hours	40,000 hours	25,000 hours	40,000 hours	25,000 hours	40,000 hours	25,000 hours	40,000 hours	25,000 hours	40,000 hours
IM V5 IM V1 / V15 IM V18 / V58														
FLSES	80 L	2	29	20	(63)	(54)	-	-	-	-	-	-	-	-
	80 LG	2; 4	26	16	(72)	(62)	45	32	(93)	(78)	-	-	-	-
	90 SL/L	2; 4; 6	26	16	(73)	(63)	42	28	(91)	(78)	53	37	(101)	(86)
	90 LU	2; 4; 6	19	9	(77)	(67)	33	20	(95)	(82)	43	28	(105)	(89)
	100 L	2; 4	36	23	(96)	(83)	56	38	(119)	(101)	-	-	-	-
	100 LR	4	-	-	-	-	55	37	(120)	(102)	-	-	-	-
	100 LG	4; 6	-	-	-	-	48	31	(116)	(99)	68	46	(137)	(115)
	112 MG	2; 6	31	18	(98)	(85)	-	-	-	-	75	53	(145)	(123)
	112 MU	4; 6	-	-	-	-	45	28	(128)	(110)	57	36	(140)	(119)
	132 SM/M	2; 4; 6	90	62	(189)	(161)	135	98	(235)	(198)	171	127	(271)	(227)
	132 MU	6	-	-	-	-	-	-	-	-	154	110	(275)	(231)
	132 MR	4	-	-	-	-	113	77	(245)	(208)	-	-	-	-
	160 M	2; 4; 6	107	72	264	229	164	117	325	277	209	152	374	317
	160 MU	6	-	-	-	-	-	-	-	-	189	133	375	319
	160 L	2; 4	94	59	256	221	174	126	331	284	-	-	-	-
	160 LUR	2; 4; 6	133	92	297	256	185	130	362	308	227	162	417	352
	180 M	2; 4	160	119	279	238	187	132	361	306	-	-	-	-
	180 MT	4	-	-	-	-	190	135	361	306	-	-	-	-
	180 MUR	2	144	102	294	252	-	-	-	-	-	-	-	-
	180 L	4; 6	-	-	-	-	206	151	346	291	233	169	391	326
	180 LUR	4; 6	-	-	-	-	187	132	355	300	183	120	377	314
	200 LU	2; 4; 6	207	153	375	320	262	190	471	398	269	186	505	422
	225 S	4	-	-	-	-	351	260	611	520	-	-	-	-
	225 SR	4	-	-	-	-	317	236	520	438	-	-	-	-
	225 M	4; 6	-	-	-	-	333	241	627	535	428	319	723	613
	225 MR	2	234	174	413	352	-	-	-	-	-	-	-	-
	250 M	2; 6	247	179	481	413	-	-	-	-	423	315	647	539
	250 MR	4	-	-	-	-	315	223	639	547	-	-	-	-
	280 S/M	2; 4; 6	396	307	484	395	507	394	670	557	602	461	793	651
	315 S/M/LA/LB	2; 6	226	156	417	347	-	-	-	-	-	-	-	-
	315 S/M/LA/LB	4	-	-	-	-	601	449	893	741	683	515	1042	873
	355 LA/LB/LC/LD	2	135	65	524	454	-	-	-	-	-	-	-	-
	355 LAL	4	-	-	-	-	516	350	1123	957	-	-	-	-
	355 LA/LB/LC/LD	4; 6	-	-	-	-	516	350	1123	957	566	364	1328	1126
	355 LKA	6	-	-	-	-	-	-	-	-	650	442	1349	1140
	355 LKB	2	965	-	271	-	-	-	-	-	-	-	-	-
	355 LKB	4	-	-	-	-	2442	-	361	-	-	-	-	-
	355 LKB	6	-	-	-	-	-	-	-	-	393	185	1624	1416
	355 LKC	6	-	-	-	-	-	-	-	-	2722	-	706	-
	400 LB	2	965	-	271	-	-	-	-	-	-	-	-	-
400 LB	4	-	-	-	-	2442	-	361	-	-	-	-	-	
450 LA	4; 6	-	-	-	-	868	-	1247	-	791	-	1668	-	
450 LB/LC/LD	4; 6	-	-	-	-	729	-	1366	-	671	-	1772	-	

(): axial loads permissible with DE bearing locked

**VERTICAL MOTOR
SHAFT FACING UP**

For a bearing life L_{10h}
of 25,000 hours
and 40,000 hours



IP55 CAST IRON MOTORS

Series	Type	No. of poles	Permissible axial load (in daN) on main shaft extension for standard bearing assembly											
			3000 min ⁻¹				1500 min ⁻¹				1000 min ⁻¹			
			25,000 hours	40,000 hours	25,000 hours	40,000 hours	25,000 hours	40,000 hours	25,000 hours	40,000 hours	25,000 hours	40,000 hours	25,000 hours	40,000 hours
IM V6 IM V3 / V36 IM V19 / V69														
	80 L	2	(59)	(50)	33	24	-	-	-	-	-	-	-	-
	80 LG	2; 4	(66)	(56)	32	22	(85)	(71)	53	39	-	-	-	-
	90 SL/L	2; 4; 6	(66)	(56)	33	23	(82)	(68)	51	38	(93)	(77)	61	46
	90 LU	2; 4; 6	(69)	(59)	27	18	(81)	(76)	43	38	(93)	(82)	55	32
	100 L	2	(86)	(72)	46	33	(106)	(88)	69	51	-	-	-	-
	100 LR	4	-	-	-	-	(105)	(87)	70	52	-	-	-	-
	100 LG	4; 6	-	-	-	-	(98)	(81)	67	49	(118)	(96)	87	66
	112 MG	2; 6	(81)	(68)	48	35	-	-	-	-	(125)	(103)	95	73
	112 MU	4; 6	-	-	-	-	(105)	(88)	68	50	(117)	(96)	80	60
	132 SM/M	2; 4; 6	(159)	(132)	120	91	(205)	(168)	165	128	(249)	(205)	179	135
	132 MU	6	-	-	-	-	-	-	-	-	(234)	(190)	195	151
	132 MR	4	-	-	-	-	(203)	(167)	155	118	-	-	-	-
	160 M	2; 4; 6	207	172	164	129	264	217	225	177	309	252	274	217
	160 MU	6	-	-	-	-	-	-	-	-	289	233	275	219
	160 L	2; 4	194	159	156	121	274	226	231	184	-	-	-	-
	160 LUR	2; 4; 6	233	192	197	156	285	230	262	208	327	262	317	252
	180 M	2; 4	208	167	231	190	250	195	298	243	-	-	-	-
	180 MT	4	-	-	-	-	290	235	261	206	-	-	-	-
	180 MUR	2	207	165	231	189	-	-	-	-	-	-	-	-
FLSES	180 L	4; 6	-	-	-	-	254	199	298	243	281	217	343	278
	180 LUR	4; 6	-	-	-	-	250	195	292	237	246	183	314	251
	200 LU	2; 4; 6	270	216	312	257	325	253	408	335	332	249	442	359
	225 S	4	-	-	-	-	414	323	548	457	-	-	-	-
	225 SR	4	-	-	-	-	380	299	457	375	-	-	-	-
	225 M	4; 6	-	-	-	-	413	321	547	455	508	399	643	533
	225 MR	2	297	237	350	289	-	-	-	-	-	-	-	-
	250 M	2; 6	327	259	401	333	-	-	-	-	423	315	647	539
	250 MR	4	-	-	-	-	395	303	559	467	-	-	-	-
	280 S/M	2; 4; 6	396	307	484	395	507	394	670	557	602	461	793	651
	315 S/M/L	2	226	156	417	347	-	-	-	-	-	-	-	-
	315 S/M/L	4; 6	-	-	-	-	601	449	893	741	683	515	1042	873
	355 LA/LB/LC/LD	2	135	65	524	454	-	-	-	-	-	-	-	-
	355 LA/LB/LC/LD	4; 6	-	-	-	-	516	350	1123	957	566	364	1328	1126
		355 LKB	2	355 LK, 400 and 450: Please consult Nidec Leroy-Somer while specifying the coupling mode and any radial and axial loads.										
	355 LKB	4; 6												
	355 LKC	6												
	400 LB	2												
	400 LB	4												
	450 LA	4; 6												
	450 LB/LC/LD	4; 6												

400 and 450: Please consult Nidec Leroy-Somer

(): axial loads permissible with DE bearing locked

Electro_Motor.ir

STANDARD FITTING ARRANGEMENT

Permissible radial load on main shaft extension with a bearing life L_{10h} of 25,000 hours.

FR : Radial Force

X: Distance with respect to the shaft shoulder

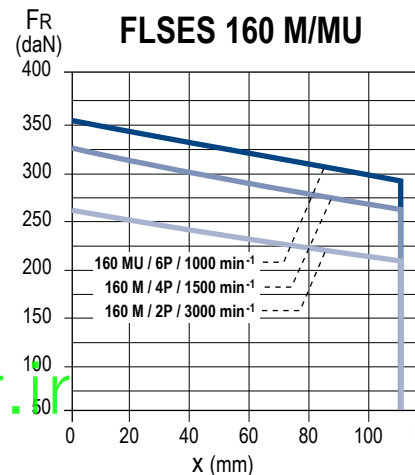
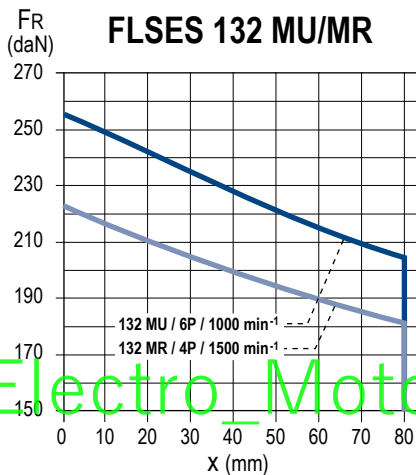
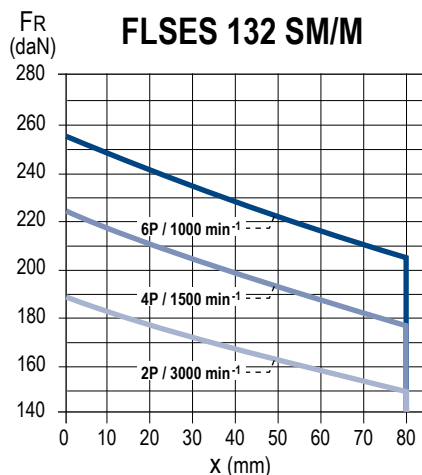
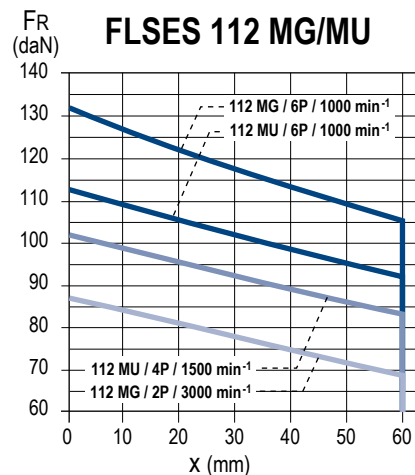
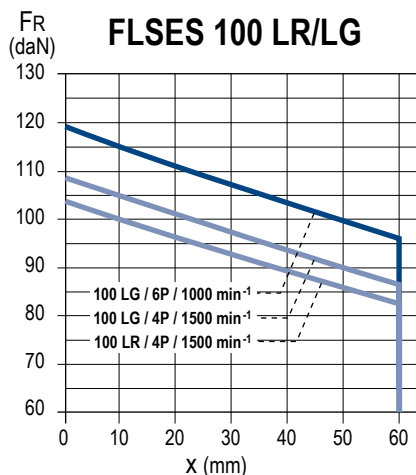
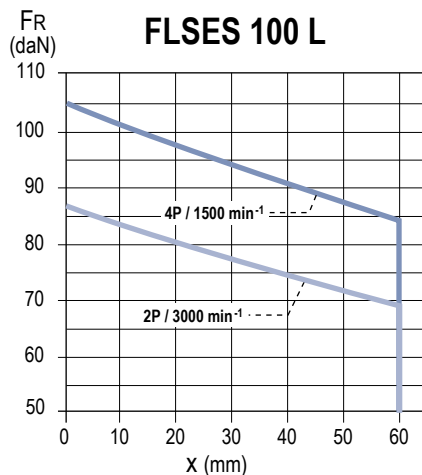
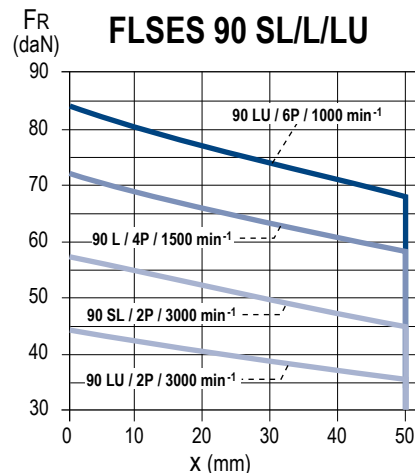
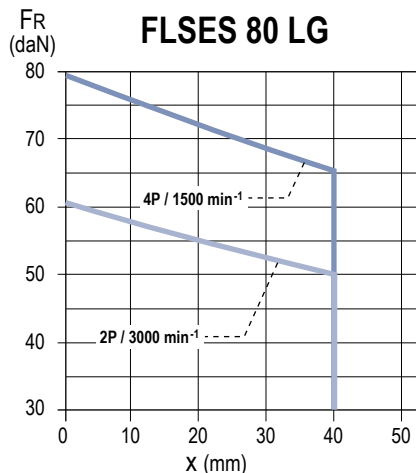
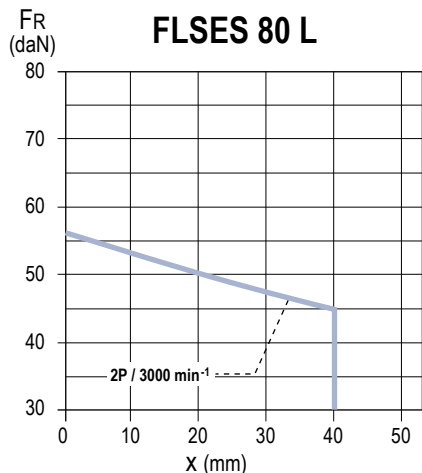

IP55 CAST IRON MOTORS

Electro_Motor.ir

STANDARD FITTING ARRANGEMENT

Permissible radial load on main shaft extension with a bearing life L_{10h} of 25,000 hours.

FR : Radial Force

X: Distance with respect to the shaft shoulder

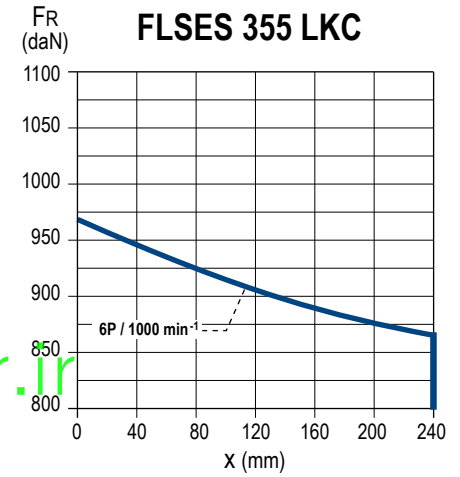
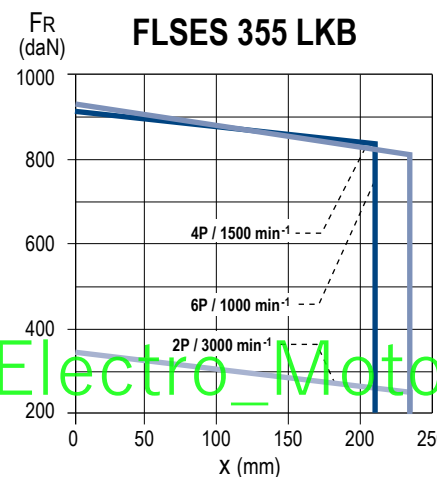
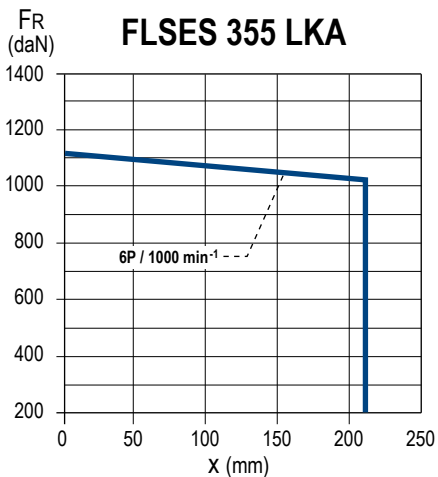
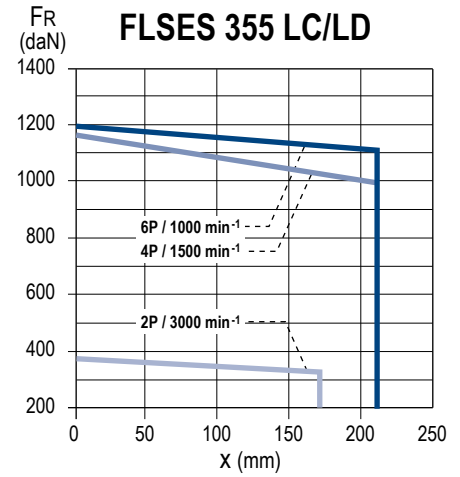
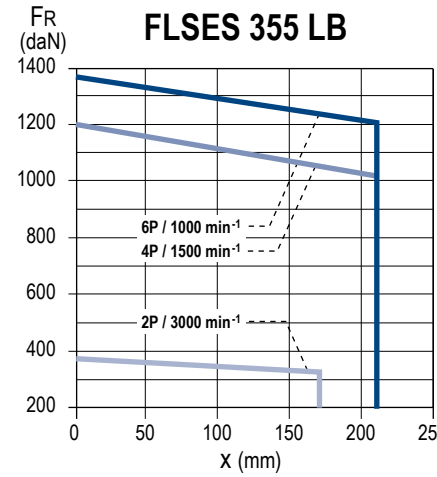
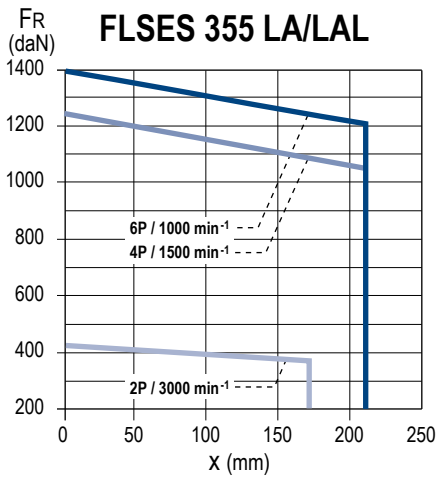
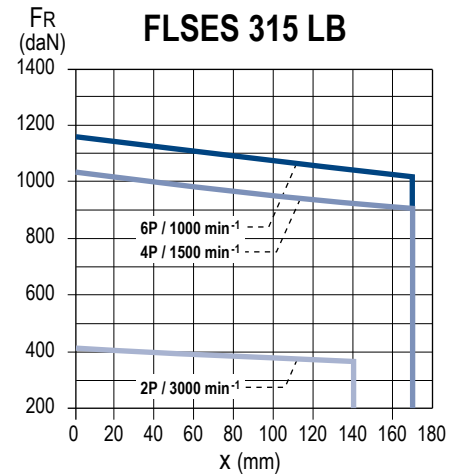
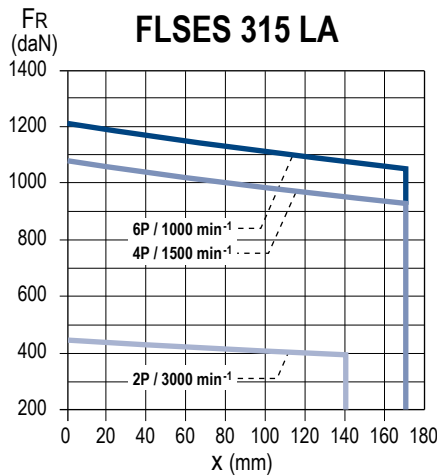
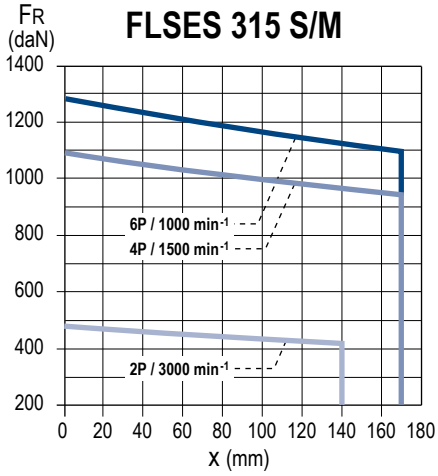

IP55 CAST IRON MOTORS

Electro_Motor.ir

STANDARD FITTING ARRANGEMENT

Permissible radial load on main shaft extension with a bearing life L_{10h} of 25,000 hours.

FR : Radial Force

X: Distance with respect to the shaft shoulder

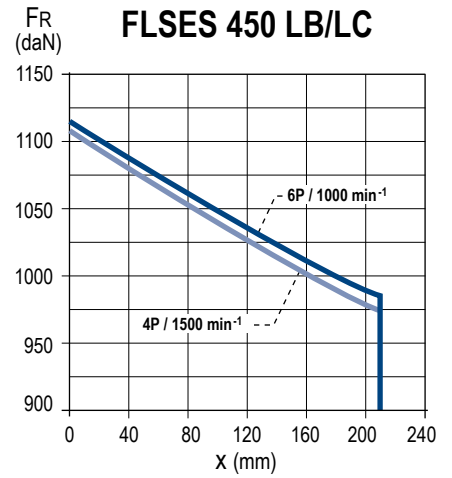
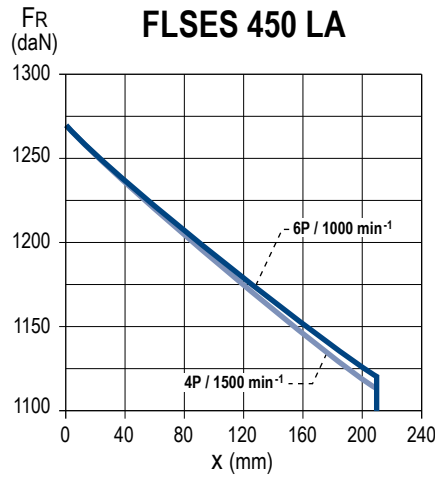
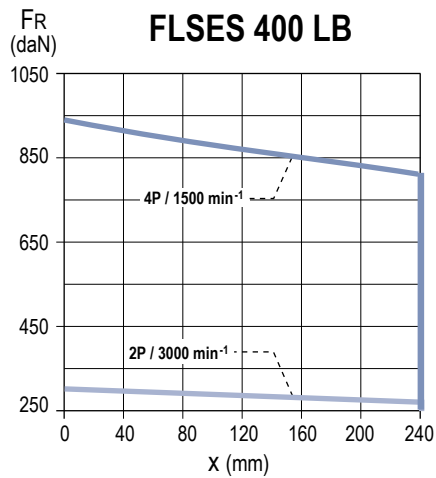

IP55 CAST IRON MOTORS

SPECIAL FITTING ARRANGEMENT

Type of drive end roller bearings

Series	Type	No. of poles	Non drive end bearing (N.D.E.)	Drive end bearing (D.E.)
FLSES	160 M/MU	4 ; 6	6210 C3	NU 309
	160 L	4		
	160 LUR	6	6210 C3	NU 310
	180 MT	4		
	180 M	4	6212 C3	NU 310
	180 L	4 ; 6	6312 C3	NU 310
	180 LUR			
	200 LU	4 ; 6	6312 C3	NU 312
	225 S	4	6314 C3	NU 314
	225 SR	4	6312 C3	NU 313
	225 M	4 ; 6	6314 C3	NU 314
	225 MR	2	6312 C3	NU 313
	250 M	6	6314 C3	NU 314
	250 MR	4		
	280 S/M	4 ; 6	6314 C3	NU 316
	315 S/M/L	4 ; 6	6316 C3	NU 320
	355 L	4 ; 6	6316 C3	NU 322
	355 LKA	6	6324 C3	NU 324
	355 LKB	2	6317 C4	-
	355 LKB	4 ; 6	6324 C3	NU 324
	355 LKC	6		
	400 LB	2	6317 C4	-
	400 LB	4 ; 6	6324 C3	NU 324
	450 LA	4	6328 C3	NU 328
	450 LA	6		
	450 LB	4		
450 LB	6			
450 LC	6			
450 LD	4			

IP55 CAST IRON MOTORS

Permissible radial load on main shaft extension with a bearing life L_{10h} of 25,000 hours.

FR : Radial Force

X: Distance with respect to the shaft shoulder

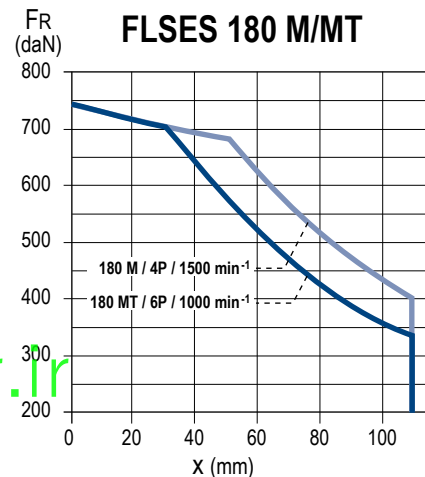
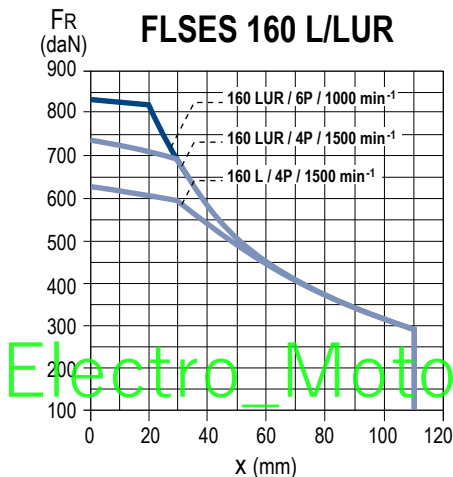
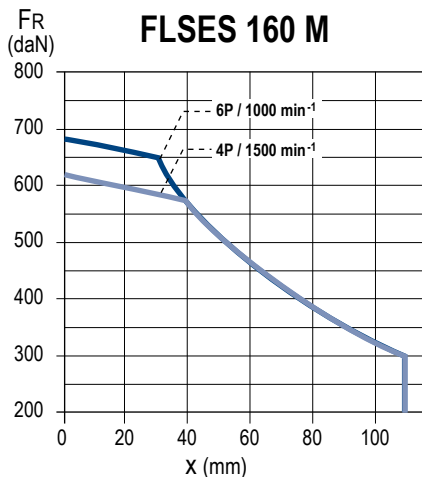

Electro_Motor.ir

SPECIAL FITTING ARRANGEMENT

Permissible radial load on main shaft extension with a bearing life L_{10h} of 25,000 hours.

FR : Radial Force

X: Distance with respect to the shaft shoulder

IP55 CAST IRON MOTORS

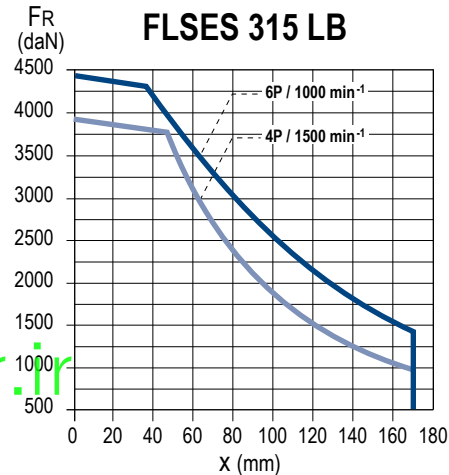
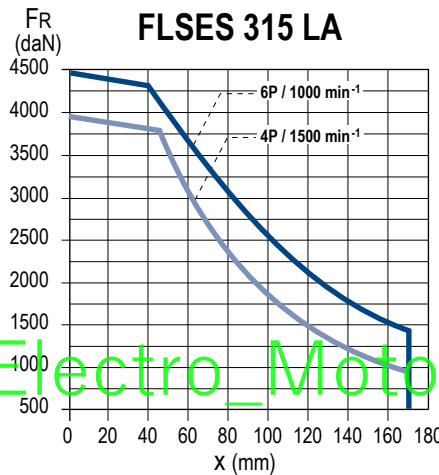
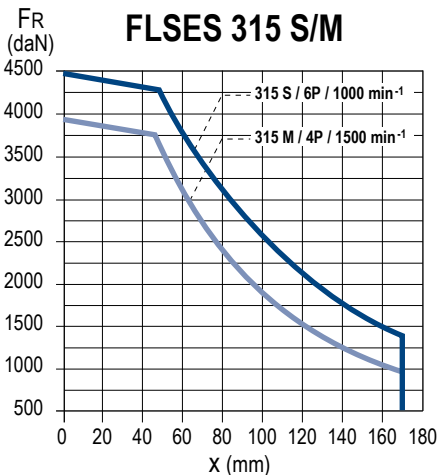
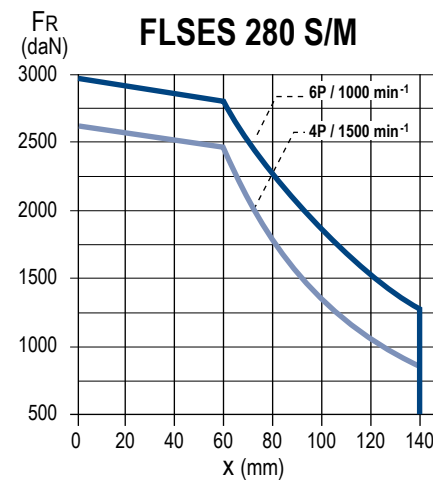
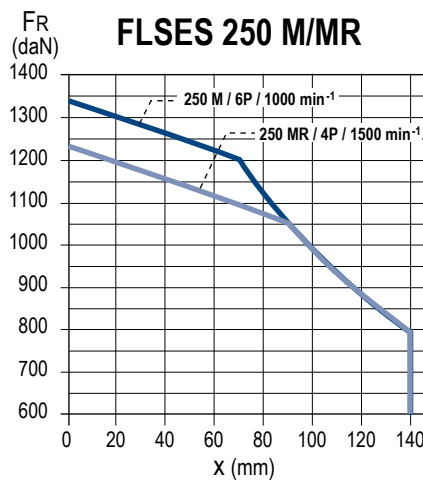
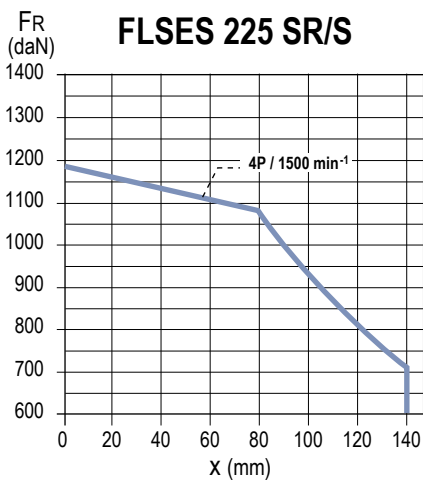
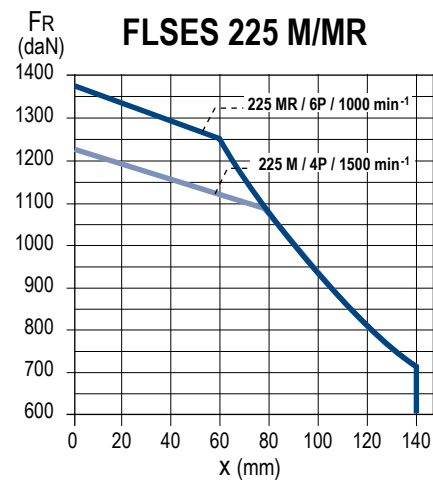
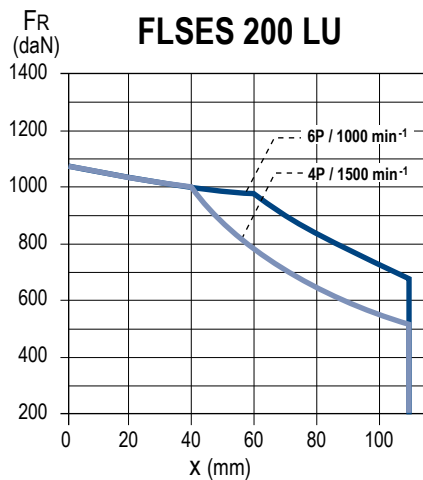
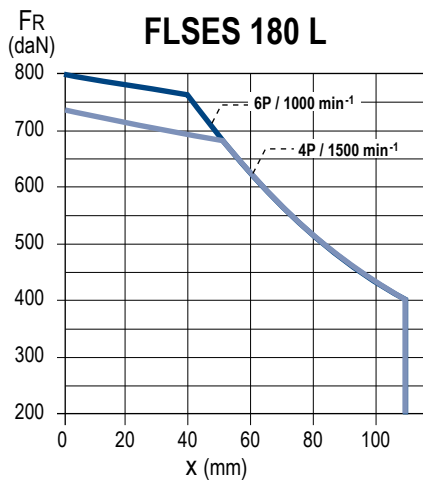

Electro_Motor.ir

SPECIAL FITTING ARRANGEMENT

Permissible radial load on main shaft extension with a bearing life L_{10h} of 25,000 hours.

FR : Radial Force

X: Distance with respect to the shaft shoulder

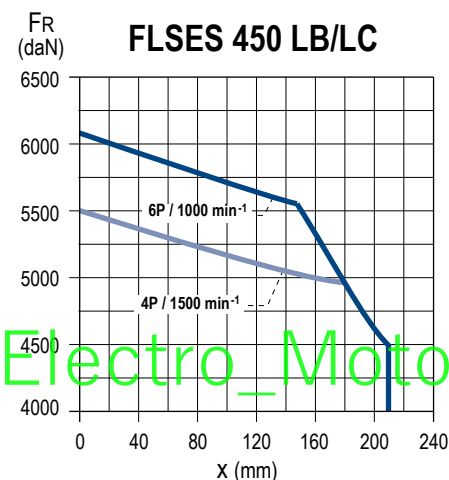
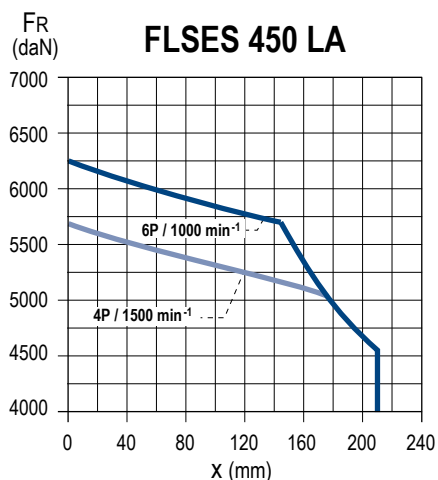
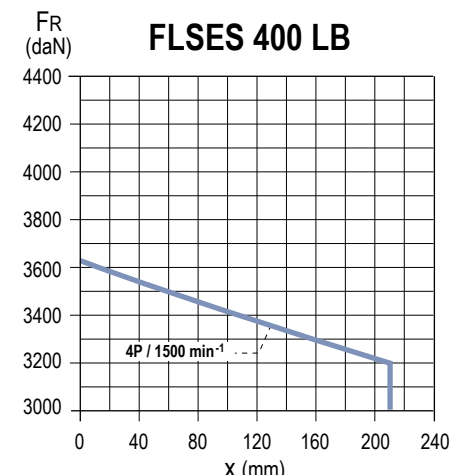
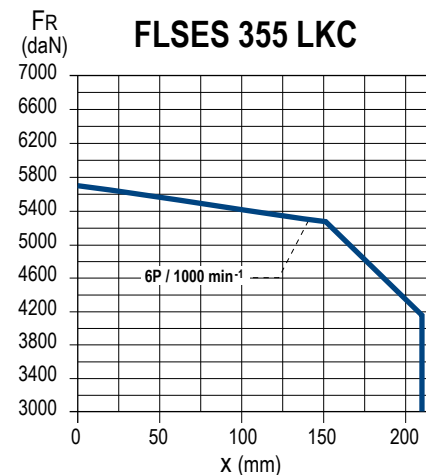
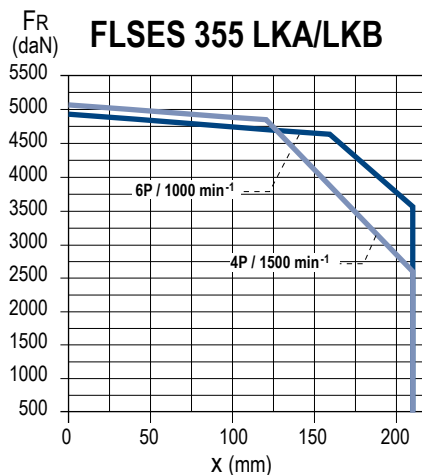
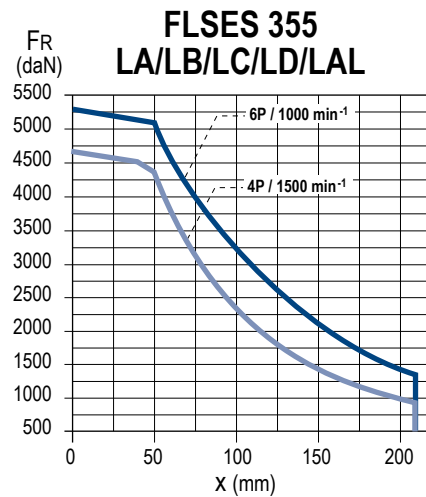
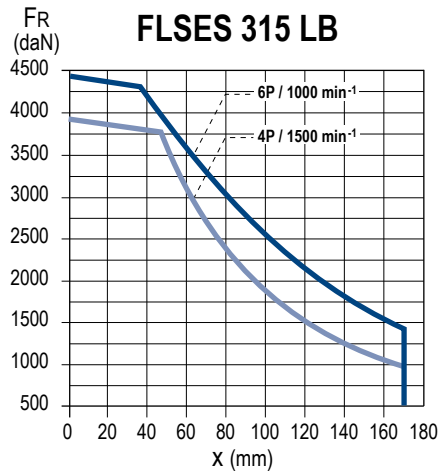
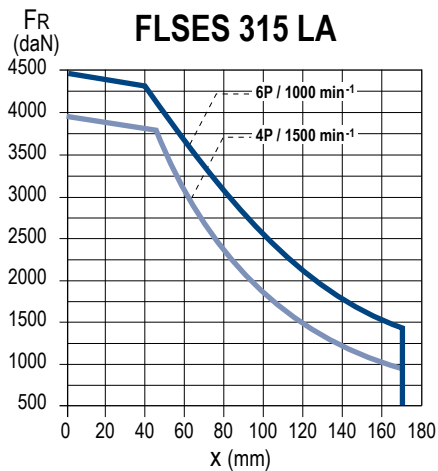

IP55 CAST IRON MOTORS

Electro_Motor.ir

Optionally, Nidec Leroy-Somer motors can be fitted with flanges and faceplates that are larger or smaller than standard. This means that motors can be adapted to all types of situation without the need for costly and time-consuming modifications.

The tables below give the flange and faceplate dimensions and also indicate flange/motor compatibility.

The bearing and shaft extension for each frame size remain standard.

Dimensions in millimetres

(FF) Flange mounted

IEC symbol	Flange dimensions						
	M	N	P	T	n	S	LA
FF 115	115	95	140	3	4	10	10
FF 130	130	110	160	3.5	4	10	10
FF 165	165	130	200	3.5	4	12	10
FF 215	215	180	250	4	4	15	12
FF 265	265	230	300	4	4	15	14
FF 300	300	250	350	5	4	18.5	14
FF 350	350	300	400	5	4	18.5	15
FF 400	400	350	450	5	8	18.5	16
FF 500	500	450	550	5	8	18.5	18**
FF 600	600	550*	660	6	8	24	22
FF 740	740	680*	800	6	8	24	22
FF 940	940	880*	1000	6	8	28	28
FF 1080	1080	1000*	1150	6	8	28	30

* Tolerance N js6

** LA = 22 for frame size ≥ 280

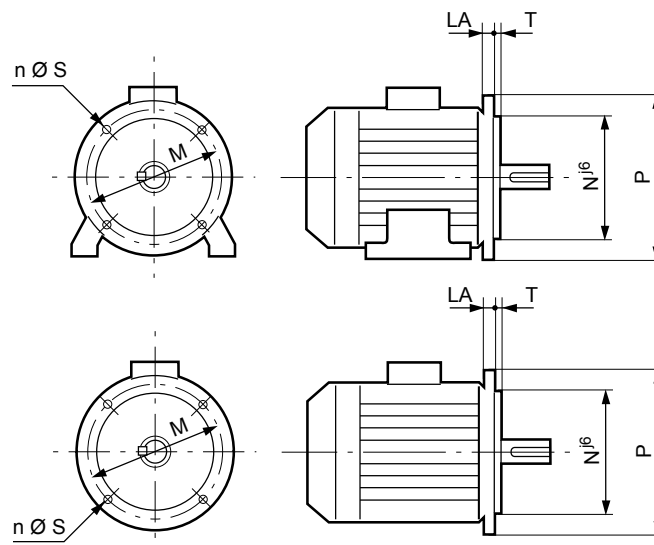

(FT) Face mounted

IEC symbol	Faceplate dimensions					
	M	N	P	T	n	M.S
FT 85	85	70	105	2.5	4	M6
FT 100	100	80	120	3	4	M6
FT 115	115	95	140	3	4	M8
FT 130	130	110	160	3.5	4	M8
FT 165	165	130	200	3.5	4	M10
FT 215	215	180	250	4	4	M12
FT 265	265	230	300	4	4	M12

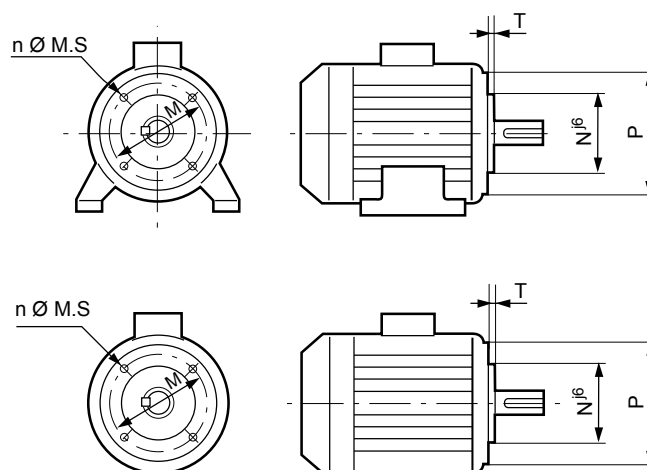

BRAKE MOTORS, FORCED VENTILATION

The integration of high-efficiency motors within a process often requires accessories to make operation easier:

- Forced ventilation for motors used at high or low speeds.

- Holding brakes for maintaining the rotor in the stop position without needing to leave the motor switched on.
- Emergency stop brakes to immobilise loads in case of failure of the motor torque control or loss of power supply.

Notes:

- Without forced ventilation, there is a possibility of overspeed with optional class B balancing.
- The motor temperature is monitored by sensors built into the windings.

FLSES series	LB dimensions with Forced Ventilation	
	Foot or face mounted motors	Flange mounted motor
80 L	317	
80 LG		
90 S	331	353
90 L		
90 LU		
100 L	373	
100 LK	422	
112 MG	412	
112 MU		
132 S		
132 MR	458	
132 M		
132 MU		
160 M		
160 L	641	
160 LU	702	
180 MR	641	
180 M		
180 L	689	
180 LUR		
200 LU	819	
225 SR	825.5	
225 MR		
225 M	917	
250 M		
280 S	1167	
280 M	1167	
315 S		
315 M	1477	
315 LA/LB		
355 LA/LB/LC/LD/LAL	1668	
355 LKA/LKB	1995	
400	Consult Nidec Leroy-Somer	
450		

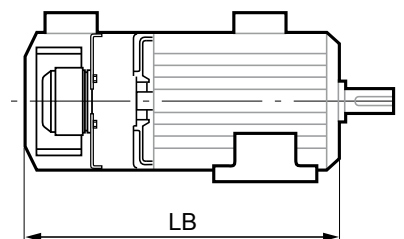

IP55 CAST IRON MOTORS

MOTORS WITH SPACE HEATERS

Type	Power (W)
FLSES 80 L	16
FLSES 80 LG to 132	25
FLSES 160 to 200	52
FLSES 225 SR/MR	
FLSES 225 M	84
FLSES 250 M	
FLSES 280 to 315	100*
FLSES 355 to 450	150*

* It is possible to increase the power when asking for estimate (quotation).

The space heaters use 200/240 V single phase, 50 or 60 Hz.

Electro_Motor.ir

IMfinity® 3-phase induction motors - IE2 - IE3 - IE4 - Non IE Efficiency

IP55 Cast iron frame

Installation and maintenance

Position of the lifting rings

LIFTING THE MOTOR ONLY (not coupled to the machine)

The regulations stipulate that over 25 kg, suitable handling equipment must be used.

All our motors are fitted with grab handles,

making them easier to handle without risk. A diagram of the sling hoisting method appears below with the required dimensions.

To prevent any damage to the motor during handling (for example: switching the motor from horizontal to vertical), it is essential to follow these instructions.

HORIZONTAL POSITION

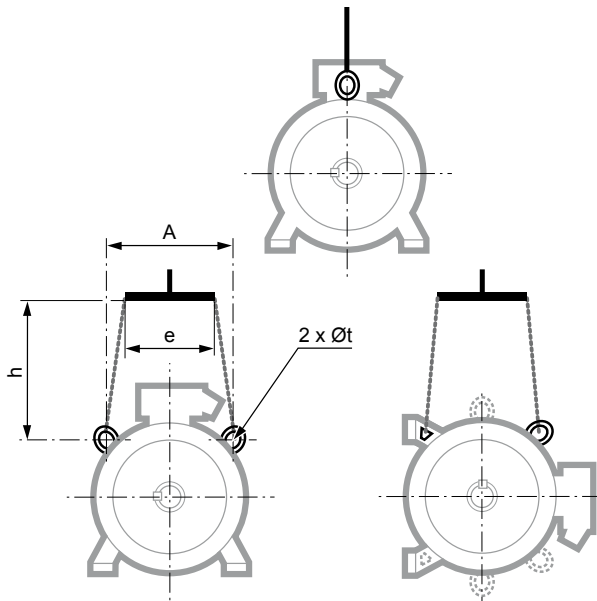

Type	Horizontal position			
	A	e min	h min	Øt
FLSES 100	152	200	150	22
FLSES 100 LG	145	200	150	22
FLSES 112	145	200	150	22
FLSES 132	180	200	150	25
FLSES 160 M/MU	200	260	150	14
FLSES 180 M/MUR/L/LUR	200	260	150	14
FLSES 200 LU	270	260	150	14
FLSES 225 SR/MR	270	260	150	14
FLSES 225 S/M	360	380	200	30
FLSES 250 M/MR	360	380	200	30
FLSES 280	360	380	500	30
FLSES 315 S/M/LA/LB	440	400	500	60
FLSES 355	545	500	500	60
FLSES 355 LK	685	710	500	30
FLSES 400	735	710	500	30
FLSES 450	730	710	500	30

VERTICAL POSITION

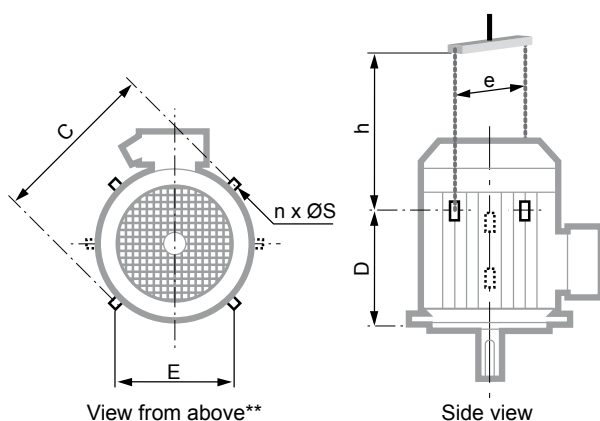

Type	Vertical position						
	C	E	D	n**	ØS	e min*	h min
FLSES 160 M/MU	320	200	230	2	14	320	350
FLSES 180 M/MUR/L/LUR*	320	200	230	2	14	320	270
FLSES 200 LU	410	300	295	2	14	410	450
FLSES 225 SR/MR	410	300	295	2	14	410	450
FLSES 225 S/M	480	360	405	4	30	540	350
FLSES 250 M/MR	480	360	405	4	30	590	550
FLSES 280 S	480	360	585	4	30	590	550
FLSES 280 M	480	360	585	4	30	590	550
FLSES 315 S/M/LA/LB	620	-	715	2	35	650	550
FLSES 355	760	-	750	2	35	800	550
FLSES 355 LK	810	350	1135	4	30	810	600
FLSES 400	810	350	1135	4	30	810	600
FLSES 450	960	400	1170	4	30	960	750

* if the motor is fitted with a drip cover, allow an additional 50 to 100 mm to avoid damaging it when the load is swung.

** if n = 2, the lifting rings form an angle of 90° with respect to the terminal box axis. If n = 4, this angle becomes 45°.

Separate ring ≤ 25 kg
Built-in ring > 25 kg

Electro_Motor.ir

IP55 CAST IRON MOTORS



IP 23
Cl. F - ΔT 80 K

The complete motor **reference** described below will enable you to **order** the desired equipment.

The selection method consists of following the terms in the designation.

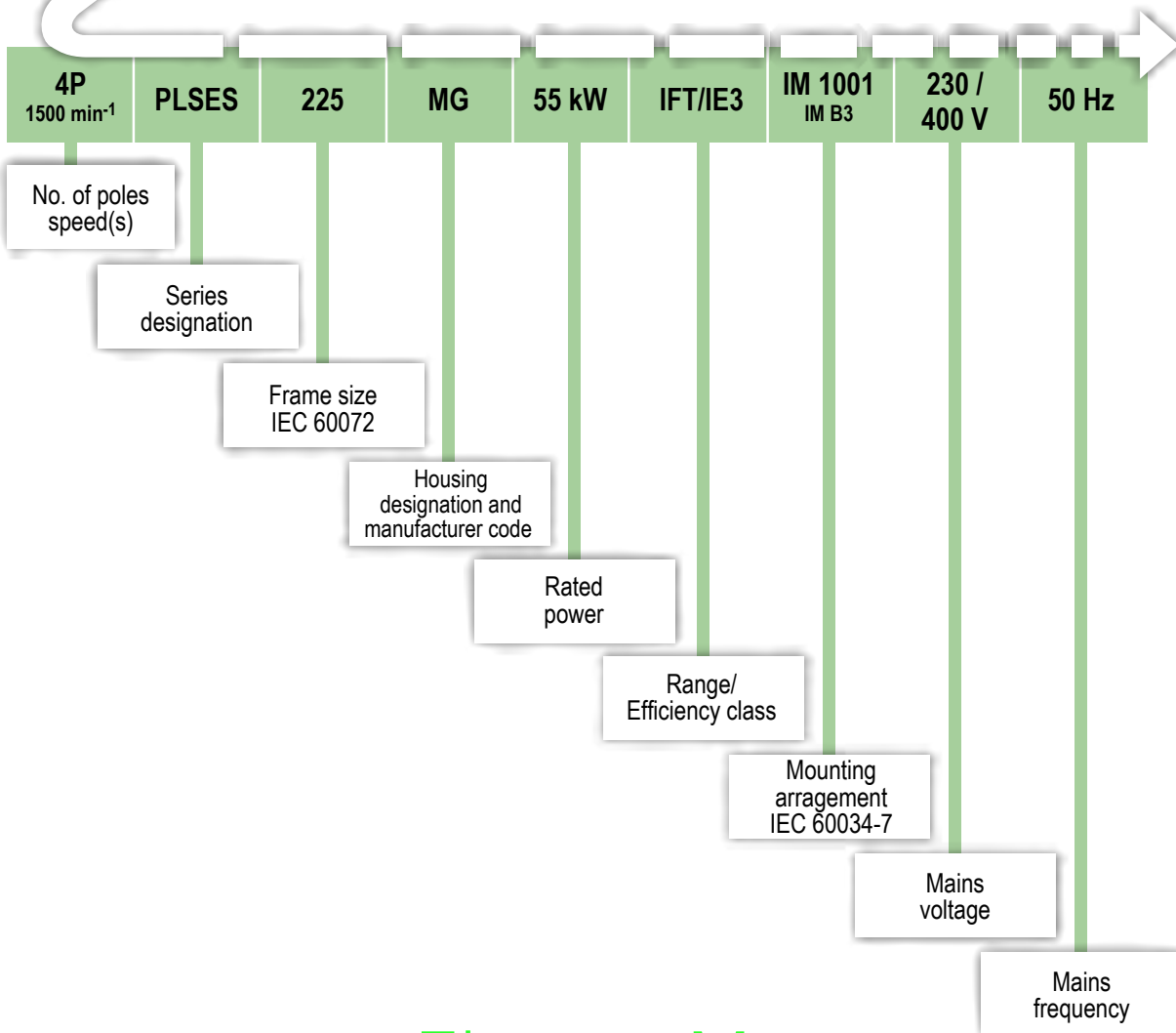

IP23 DRIP-PROOF MOTORS

Electro_Motor.ir

IMfinity® 3-phase induction motors - IE2 - IE3 - IE4 - Non IE Efficiency

IP23 Steel frame

General information

Description

Component	Materials	Remarks
Housing	Steel	- gravity or low pressure die casting, frame size ≤ 250 - lifting rings
Stator	Insulated low-carbon magnetic steel laminations Electroplated copper	- low carbon content guarantees long-term lamination pack stability - welded laminations - semi-enclosed slots - class F insulation
Rotor	Insulated low-carbon magnetic steel laminations Aluminium or copper	- inclined cage bars - rotor cage pressure die-cast in aluminium - rotor cage shrink-fitted to shaft - rotor balanced dynamically, class A, 1/2 key
Shaft	Steel	
End shields	Cast iron or steel	
Bearings and lubrication		Standard mounting: - ball bearings C3 play - permanently greased bearings for frame size ≤ 200 - regreasable bearings from frame size 225 upwards - bearings preloaded at non drive end
Labyrinth seal Lipseals	Plastic or steel Synthetic rubber	- lipseal at drive end for all motors
Fan	Composite Aluminium or steel alloy	- bidirectional fan in motors with 2 poles (P ≤ 250 kW), 4 poles for frame size 180 to 315 except 315 MGU and LG - unidirectional fan (direction of rotation to be specified at time of ordering) in motors with 2 poles, for frame size 315 MGU and LG
Fan cover	Pressed steel	- fitted, on request, with a drip cover for operation in vertical position, shaft end facing up
Terminal box	Composite Aluminium alloy or steel	- can be turned in 4 directions, opposite the feet - fitted as standard with a terminal block with 6 steel terminals - terminal box comes fitted with threaded plugs for frame size ≤ 280 SD/MD, for motors 280 MG to 315 and larger sizes, terminal box comes complete with a removable undrilled cable gland support plate, without cable gland - 1 earth terminal in each terminal box

In the standard version, the motors are wound 400 V 50 Hz with connection Δ

Electro_Motor.ir

IMfinity® 3-phase induction motors - IE2 - IE3 - IE4 - Non IE Efficiency

IP23 Steel frame

Electrical and mechanical characteristics

IE2 - Powered by the mains

Type	Rated power P_n kW	Rated torque M_n N.m	Starting torque/ Rated torque M_d/M_n	Maximum torque/ Rated torque M_m/M_n	Starting current/ Rated current I_d/I_n	Moment of inertia J kg.m ²	Weight IM B3 kg	Noise LP db(A)	400V / 50Hz							
									Rated speed N_n min ⁻¹	Rated current I_n A	Efficiency IEC 60034-2-1 2014 η			Power factor $\cos \phi$		
											4/4	3/4	2/4	4/4	3/4	2/4
2 poles																
PLSES 225MG	75	241	2.31	2.85	7.5	0.335	365	85	2972	132	94.10	94.30	93.80	0.87	0.84	0.77
PLSES 250SF	90	289	2.52	3.6	8.05	0.408	430	84	2972	156	94.40	94.70	94.40	0.88	0.86	0.80
PLSES 250MF	110	353	2.86	3.7	8.85	0.479	465	85	2974	193	94.60	94.80	94.40	0.87	0.84	0.77
PLSES 280MD	132	424	2	3.15	8.24	0.573	500	83	2970	224	95.00	95.40	95.40	0.90	0.88	0.83
PLSES 315SU	160	513	2.31	3.05	7.7	1.05	700	80	2978	282	95.10	95.20	94.70	0.86	0.83	0.75
PLSES 315M	200	641	2.16	3.25	7.1	1.12	720	84	2978	369	95.20	95.20	94.60	0.82	0.77	0.67
PLSES 315L	250	803	2.16	2.9	6.85	1.26	790	85	2974	441	95.20	95.40	95.10	0.86	0.83	0.75
PLSES 315LD	280	898	2.21	2.85	6.7	1.37	920	86	2976	493	95.40	95.40	94.80	0.86	0.83	0.76
PLSES 315LD	315	1010	2.11	2.95	6.5	1.66	930	87	2976	561	95.30	95.50	95.20	0.85	0.82	0.75
4 poles																
PLSES 225MG	55	354	2.06	2.9	6.95	0.648	375	76	1484	103	93.90	94.10	93.70	0.82	0.78	0.68
PLSES 250SF	75	482	2.3	3.05	7.28	0.778	430	76	1486	144	94.20	94.40	94.00	0.80	0.78	0.64
PLSES 250MF	90	579	2.4	3.05	7.76	0.956	495	77	1484	169	94.60	94.80	94.50	0.81	0.76	0.65
PLSES 280SGJ	110	706	3	2.8	7.18	2.08	680	79	1488	201	95.20	95.20	94.50	0.83	0.79	0.69
PLSES 280MG	132	847	2.46	2.8	7.3	2.29	715	80	1488	241	95.30	95.40	94.90	0.83	0.79	0.70
PLSES 315SUR	160	1030	2.6	3	7.1	2.43	750	80	1488	300	95.00	95.00	94.40	0.81	0.76	0.64
PLSES 315MU	200	1290	3.1	2.95	7.2	2.77	825	80	1486	374	95.10	95.10	94.10	0.81	0.75	0.64
PLSES 315LUS	250	1610	2.76	2.75	6.55	3.24	925	85	1486	473	95.30	95.40	94.90	0.80	0.75	0.64
PLSES 315LU	280	1800	2.37	2.2	5.85	3.44	960	83	1484	504	95.60	96.10	95.90	0.84	0.81	0.72

Type	Rated power at 50Hz P_n kW	380V / 50Hz				415V / 50Hz				460V / 60Hz				
		Rated speed N_n min ⁻¹	Rated current I_n A	Efficiency η 4/4	Power factor $\cos \phi$ 4/4	Rated speed N_n min ⁻¹	Rated current I_n A	Efficiency η 4/4	Power factor $\cos \phi$ 4/4	Rated speed N_n min ⁻¹	Rated torque at 60Hz M_n N_m	Rated current I_n A	Efficiency η 4/4	Power factor $\cos \phi$ 4/4
		N_n min ⁻¹	I_n A	η 4/4	$\cos \phi$ 4/4	N_n min ⁻¹	I_n A	η 4/4	$\cos \phi$ 4/4	N_n min ⁻¹	M_n N_m	I_n A	η 4/4	$\cos \phi$ 4/4
2 poles														
PLSES 225MG	75	2968	138	93.80	0.88	2974	129	94.20	0.86	3576	200	114	95.10	0.87
PLSES 250SF	90	2970	161	94.10	0.90	2974	151	94.50	0.88	3576	240	135	95.50	0.88
PLSES 250MF	110	2974	199	94.30	0.89	2976	187	94.70	0.86	3578	294	164	95.90	0.88
PLSES 280MD	132	2966	233	94.70	0.91	2972	216	95.20	0.89	3576	352	192	96.20	0.90
PLSES 315SU	160	2978	292	94.80	0.88	2978	279	95.20	0.84	3564	429	244	96.20	0.86
PLSES 315M	200	2974	377	95.00	0.85	2978	374	95.00	0.78	3580	533	315	96.10	0.83
PLSES 315L	250	2970	458	95.10	0.87	2976	436	95.20	0.84	3578	667	379	96.30	0.86
PLSES 315LD	280	2972	508	95.30	0.88	2978	488	95.30	0.84	3580	747	419	96.30	0.87
PLSES 315LD	315	2972	576	95.30	0.87	2978	555	95.30	0.83	3582	840	486	95.70	0.85
4 poles														
PLSES 225MG	55	1482	106	93.50	0.84	1486	101	94.10	0.80	1786	294	90	94.60	0.81
PLSES 250SF	75	1482	147	94.00	0.82	1486	142	94.30	0.78	1786	401	125	94.50	0.80
PLSES 250MF	90	1482	174	94.20	0.83	1486	168	94.70	0.79	1788	481	149	94.90	0.80
PLSES 280SGJ	110	1486	206	95.10	0.85	1490	199	95.30	0.81	1790	587	177	95.30	0.82
PLSES 280MG	132	1488	247	95.20	0.85	1488	238	95.30	0.81	1790	704	211	95.20	0.83
PLSES 315SUR	160	1486	306	94.90	0.84	1488	299	95.00	0.78	1780	858	262	95.80	0.80
PLSES 315MU	200	1486	379	95.10	0.84	1488	377	94.80	0.78	1790	1067	329	95.40	0.80
PLSES 315LUS	250	1484	480	95.20	0.83	1486	476	95.10	0.77	1790	1334	412	95.60	0.80
PLSES 315LU	280	1480	520	95.40	0.86	1484	497	95.80	0.82	1788	1495	437	95.90	0.84

Electro_Motor.ir

IMfinity® 3-phase induction motors - IE2 - IE3 - IE4 - Non IE Efficiency

IP23 Steel frame

Electrical and mechanical characteristics

IE2 - Powered by the drive

Type	400V 50Hz				Rated torque M_n at S1 continuous duty					400V / 87Hz Δ				Maximum mechanical speed ¹
	Rated power	Rated speed	Rated current	Power factor	10Hz	17Hz	25Hz	50Hz	87Hz	Rated power	Rated speed	Rated current	Power factor	
	P_n kW	N_n min ⁻¹	I_n A	Cos φ 4/4	N.m	N.m	N.m	N.m	N.m	P_n kW	N_n min ⁻¹	I_n A	Cos φ 4/4	
2 poles														
PLSES 225 MG	75	2968	132	0.89	169	205	236	241	-	-	-	-	-	3600
PLSES 250 SF	90	2970	156	0.90	188	225	260	289	-	-	-	-	-	3600
PLSES 250 MF	110	2974	193	0.89	229	275	318	353	-	-	-	-	-	3600
PLSES 280 MD	132	2962	225	0.90	254	305	352	391	-	-	-	-	-	3600
PLSES 315 SU	160	2978	282	0.88	359	410	462	513	-	-	-	-	-	3600
PLSES 315 M	200	2974	369	0.85	417	481	545	641	-	-	-	-	-	3600
PLSES 315 L	250	2970	441	0.87	407	518	591	739	-	-	-	-	-	3600
PLSES 315 L	280	2972	493	0.88	522	602	642	803	-	-	-	-	-	3600
PLSES 315 LD	315	2972	561	0.87	583	627	717	896	-	-	-	-	-	3600
4 poles														
PLSES 225 MG	55	1482	110	0.84	248	319	354	354	203	96	2592	191	0.84	3240
PLSES 250 SF	75	1482	151	0.82	318	386	434	482	277	131	2592	263	0.82	3240
PLSES 250 MF	90	1482	181	0.82	353	405	481	579	333	157	2592	314	0.82	3240
PLSES 280 SGJ	110	1486	213	0.85	565	706	706	706	406	191	2596	372	0.85	2700
PLSES 280 MG	132	1488	253	0.85	678	822	847	847	487	230	2598	440	0.85	2700
PLSES 315 SUR	160	1486	314	0.83	773	865	979	1030	592	278	2596	547	0.83	3420
PLSES 315 MU	200	1486	389	0.84	929	1084	1226	1290	741	348	2596	677	0.84	3420
PLSES 315 LUS	250	1484	490	0.83	1127	1288	1449	1610	925	-	-	-	-	3420
PLSES 315 LU	280	1480	1990	0.86	1170	1337	1505	1672	961	-	-	-	-	2610

(1) See Vibrations section on page 42



Values given with a voltage drop of 30 V at the drive output

Electro_Motor.ir

IP23 DRIP-PROOF MOTORS

IMfinity® 3-phase induction motors - IE2 - IE3 - IE4 - Non IE Efficiency

IP23 Steel frame

Electrical and mechanical characteristics

IE3 - Powered by the mains

Type	Rated power P _n kW	Rated torque M _n N.m	Starting torque/ Rated torque M _d /M _n	Maximum torque/ Rated torque M _m /M _n	Starting current/ Rated current I _d /I _n	Moment of inertia J kg.m ²	Weight IM B3 kg	Noise LP db(A)	400V / 50Hz							
									Rated speed N _n min ⁻¹	Rated current I _n A	Efficiency IEC 60034-2-1 2014			Power factor		
											4/4	3/4	2/4	4/4	3/4	2/4
2 poles																
PLSES 225MG	75	241	2.3	2.85	7.5	0.335	365	85	2972	131	95.10	95.30	94.80	0.87	0.85	0.77
PLSES 250SF	90	289	2.5	3.6	8.1	0.408	430	84	2972	155	95.40	95.70	95.40	0.88	0.86	0.80
PLSES 250MF	110	353	2.85	3.7	9.00	0.479	465	85	2974	190	95.80	95.90	95.60	0.87	0.84	0.77
PLSES 280MD	132	424	2.45	3.4	8.5	0.573	500	83	2970	221	95.80	96.20	96.10	0.90	0.88	0.83
PLSES 315SU	160	513	2.3	3.05	7.8	1.05	700	80	2978	279	96.20	96.20	95.70	0.86	0.83	0.75
PLSES 315M	200	641	2.15	3.25	7.1	1.12	720	84	2978	367	95.90	95.90	95.30	0.82	0.77	0.67
PLSES 315L	250	803	2.15	2.9	6.95	1.26	790	85	2974	437	96.00	96.30	96.00	0.86	0.83	0.75
PLSES 315LD	280	898	2.2	2.85	6.75	1.37	920	86	2976	489	96.10	96.10	95.40	0.86	0.83	0.76
PLSES 315MGU	315	1012	1.5	2.26	5.78	2.47	1082	80	2971	533	95.80	96.30	95.80	0.89	0.89	0.86
PLSES 315LG	355	1139	1.78	2.7	6.78	2.76	1160	80	2977	605	96.30	96.70	96.50	0.88	0.87	0.84
PLSES 315LG	400	1282	1.8	2.73	6.65	3.1	1250	80	2980	674	96.30	96.70	96.50	0.89	0.88	0.85
PLSES 315VLG	450	1441	1.86	2.78	7.21	3.5	1340	80	2982	762	96.20	96.40	96.00	0.88	0.87	0.82
PLSES 315VLGU	500	1605	1.66	2.7	6.3	3.5	1385	83	2975	862	96.20	96.20	94.58	0.87	0.86	0.75
PLSES 355MA	500	1606	1.79	2.15	6.1	4.5	1948	89	2973	835	96.40	96.26	95.55	0.90	0.90	0.89
PLSES 355MB	560	1801	1.6	1.92	5.4	4.5	1948	89	2970	944	96.20	96.20	96.10	0.89	0.90	0.89
PLSES 355MC	630	2032	2	2.18	5	4.5	1948	89	2969	1036	96.29	96.61	96.50	0.92	0.92	0.91
PLSES 355LA	710	2277	2.15	2.58	7.27	5.74	2435	89	2982	1177	97.10	97.15	96.80	0.90	0.90	0.87
PLSES 355LB	800	2557	1.91	2.3	6.46	5.74	2435	89	2980	1323	97.00	97.15	96.85	0.90	0.90	0.88
4 poles																
PLSES 225MG	55	354	2.2	2.7	6.55	0.7806	420	69	1484	110	94.60	95.00	94.80	0.83	0.80	0.71
PLSES 250SF	75	483	2.35	3.2	7.93	0.9594	480	69	1484	139	95.00	95.10	94.60	0.82	0.78	0.68
PLSES 250MF	90	578	2.6	3.15	8.3	1.0809	510	70	1486	166	95.30	95.60	95.10	0.81	0.75	0.64
PLSES 280SGJ	110	706	3	2.8	7.25	2.08	680	79	1488	200	95.80	95.80	95.10	0.83	0.79	0.69
PLSES 280MG	132	847	2.45	2.8	7.35	2.29	715	80	1488	239	96.10	96.20	95.70	0.83	0.79	0.70
PLSES 315SUR	160	1030	2.8	2.95	7.55	2.8625	820	79	1488	292	96.30	96.40	95.80	0.82	0.78	0.67
PLSES 315MUR	200	1280	2.97	2.92	7.46	3.3365	910	79	1488	358	96.00	96.00	95.60	0.84	0.80	0.70
PLSES 315LUS	250	1610	3	2.95	7.42	3.5966	960	83	1486	452	96.20	96.40	96.00	0.83	0.79	0.70
PLSES 315LG	280	1797	2.23	2.87	7.89	5.84	1170	83	1488	511	96.60	96.80	96.60	0.84	0.81	0.73
PLSES 315LG	315	2024	2	2.55	7.26	5.84	1170	83	1487	555	96.40	96.70	96.50	0.85	0.82	0.74
PLSES 315LG	355	2280	2.2	2.8	6.97	5.84	1170	83	1487	650	96.20	96.30	96.00	0.82	0.77	0.66
PLSES 315VLG	400	2571	2.2	2.77	6.84	6.48	1327	83	1486	722	96.40	96.70	96.50	0.83	0.79	0.69
PLSES 315VLGU	450	2890	2.7	3.12	7.63	7.3	1400	83	1487	820	96.50	96.70	96.50	0.82	0.77	0.67
PLSES 315VLGU	500	3217	2.7	2.8	8.07	7.3	1500	83	1484	917	96.00	96.40	96.30	0.82	0.79	0.71
PLSES 355MA	500	3204	1.1	2.67	6.72	9.9	2041	88	1490	849	96.60	96.58	96.08	0.88	0.87	0.82
PLSES 355MB	560	3594	1	2.38	6	9.9	2041	88	1488	951	96.60	96.70	96.35	0.88	0.87	0.84
PLSES 355LA	630	4040	1.1	2.69	6.7	11.3	2295	88	1489	1071	96.50	96.53	96.13	0.88	0.87	0.81
PLSES 355LB	710	4564	1.4	3	7.58	12.4	2454	88	1488	1205	96.90	97.08	96.93	0.88	0.86	0.79
PLSES 355LC	750	4810	1.4	3	7.89	12.4	2454	88	1492	1284	97.10	97.20	96.90	0.87	0.84	0.77
PLSES 400LB	800	5117	2.6	2.2	7.80	25	3050	98	1493	1414	96.10	96.20	96.00	0.85	0.83	0.73
PLSES 400LB	900	5761	2.4	2.1	7.20	25	3050	101	1492	1611	96.00	96.10	95.90	0.84	0.82	0.72
6 poles																
PLSES 355LA	400	3850	1.7	2.5	6.7	14.5	2210	78	992	714	96.30	96.30	95.80	0.84	0.80	0.71
PLSES 355LB	450	4332	1.7	2.5	6.6	15.4	2245	78	992	802	96.40	96.45	96.00	0.84	0.80	0.72
PLSES 355LC	500	4813	2	2.6	6.6	16.3	2320	78	992	899	96.70	96.80	96.30	0.83	0.79	0.70
PLSES 355LD	560	5390	1.7	2.5	6.6	18.0	2450	78	992	1020	96.60	96.70	96.20	0.82	0.77	0.67
PLSES 400LB	630	6058	2	2.38	6.3	38.0	3100	84	993	1113	96.10	96.20	96.10	0.85	0.84	0.79
PLSES 400LD	710	6819	2.4	2.65	7.4	50.0	3300	84	994	1331	96.20	96.3	96.20	0.80	0.79	0.74

IP23 DRIP-PROOF MOTORS

Electro_Motor.ir

IMfinity® 3-phase induction motors - IE2 - IE3 - IE4 - Non IE Efficiency

IP23 Steel frame

Electrical and mechanical characteristics

IE3 - Powered by the mains

Type	Rated power at 50Hz P_n kW	380V / 50Hz				415V / 50Hz				460V / 60Hz				
		Rated speed	Rated current	Efficiency	Power factor	Rated speed	Rated current	Efficiency	Power factor	Rated speed	Rated power at 60Hz	Rated current	Efficiency	Power factor
		N_n min ⁻¹	I_n A	η 4/4	$\cos \phi$ 4/4	N_n min ⁻¹	I_n A	η 4/4	$\cos \phi$ 4/4	N_n min ⁻¹	M_n N_n	I_n A	η 4/4	$\cos \phi$ 4/4
2 poles														
PLSES 225MG	75	2968	135	94.80	0.89	2974	127	95.20	0.86	3576	200	114	95.10	0.87
PLSES 250SF	90	2970	160	95.10	0.90	2974	149	95.60	0.88	3576	240	134	95.50	0.88
PLSES 250MF	110	2974	197	95.40	0.89	2976	186	95.90	0.86	3578	294	164	95.90	0.88
PLSES 280MD	132	2966	231	95.50	0.91	2972	215	96.00	0.89	3576	352	191	96.20	0.90
PLSES 315SU	160	2978	288	96.00	0.88	2978	275	96.20	0.84	3564	429	243	96.20	0.86
PLSES 315M	200	2974	373	95.80	0.85	2978	372	95.80	0.78	3580	533	315	96.10	0.83
PLSES 315L	250	2970	455	95.90	0.87	2976	431	96.00	0.84	3578	667	378	96.40	0.86
PLSES 315LD	280	2972	504	96.00	0.88	2978	483	96.00	0.84	3580	747	419	96.30	0.87
PLSES 315MGU	315	2965	549	95.80	0.89	2980	517	96.30	0.88	3577	841	459	95.80	0.90
PLSES 315LG	355	2972	619	96.00	0.89	2980	582	96.40	0.88	3577	948	517	95.80	0.90
PLSES 315L	400	2972	711	96.00	0.89	2980	656	96.40	0.88	3580	1067	589	95.80	0.89
PLSES 315VLG	450	2972	800	96.00	0.89	2981	738	96.40	0.88	3582	1200	670	95.80	0.88
PLSES 315VLGU	500	2972	901	95.80	0.88	2977	843	96.00	0.86	3575	1336	753	95.80	0.87
PLSES 355MA	500	2970	880	96.20	0.90	2975	800	96.57	0.90	3575	1336	721	96.70	0.90
PLSES 355MB	560	2966	1001	96.00	0.89	2972	906	96.20	0.89	3572	1497	813	96.40	0.90
PLSES 355MC	630	2962	1098	96.07	0.91	2972	995	96.68	0.92	3572	1684	889	96.60	0.92
PLSES 355LA	710	2978	1232	96.86	0.91	2984	1131	97.21	0.90	3584	1892	1017	97.30	0.90
PLSES 355LB	800	2976	1397	96.70	0.90	2982	1268	97.10	0.90	3582	2133	1149	97.10	0.90
4 poles														
PLSES225MG	55	1480	104	94.60	0.85	1486	98	94.80	0.82	1786	294	87	95.40	0.84
PLSES250SF	75	1484	143	95.00	0.84	1488	137	95.00	0.80	1790	400	122	95.40	0.81
PLSES250MF	90	1484	173	95.20	0.83	1488	166	95.60	0.79	1790	480	147	95.80	0.80
PLSES280SGJ	110	1486	205	95.70	0.85	1490	197	96.00	0.81	1790	587	176	95.90	0.82
PLSES280MG	132	1488	246	96.00	0.85	1488	236	96.10	0.81	1790	704	207	96.20	0.83
PLSES315SUR	160	1488	298	95.90	0.85	1492	289	96.20	0.80	1790	854	254	96.30	0.82
PLSES315MUR	200	1484	372	96.00	0.85	1488	353	96.00	0.82	1790	1067	314	96.30	0.82
PLSES315LUS	250	1484	465	96.00	0.85	1488	446	96.20	0.81	1790	1334	397	96.40	0.82
PLSES315L	280	1486	520	96.20	0.85	1489	487	96.40	0.83	1788	1495	435	96.00	0.84
PLSES315LG	315	1485	580	96.00	0.86	1488	541	96.50	0.84	1787	1683	484	96.20	0.85
PLSES315L	355	1486	660	96.10	0.85	1489	651	96.00	0.79	1788	1896	565	96.20	0.82
PLSES315VLG	400	1485	744	96.10	0.85	1489	713	96.40	0.81	1786	2139	629	96.20	0.83
PLSES315VLGU	450	1486	834	96.40	0.85	1489	812	96.40	0.80	1787	2405	716	96.20	0.82
PLSES315VLGU	500	1479	953	96.00	0.83	1485	895	96.00	0.81	1784	2676	796	96.20	0.82
PLSES355MA	500	1489	896	96.38	0.88	1491	823	96.76	0.87	1791	2666	736	96.90	0.88
PLSES355MB	560	1486	1004	96.30	0.88	1489	925	96.80	0.87	1790	2987	823	97.00	0.88
PLSES355LA	630	1488	1123	96.28	0.89	1490	1040	96.66	0.87	1790	3361	927	96.85	0.88
PLSES355LB	710	1487	1261	96.70	0.89	1489	1175	97.00	0.87	1789	3790	1045	97.20	0.88
PLSES355LC	750	1491	1351	96.94	0.87	1492	1251	97.20	0.86	1792	3997	1125	97.30	0.86
PLSES400LB	800	1492	1472	96.00	0.86	1494	1397	96.00	0.83	1794	4258	1228	96.20	0.85
PLSES400LB	900	1491	1656	96.00	0.86	1493	1591	96.00	0.82	1793	4793	1398	96.20	0.84
6 poles														
PLSES 355LA	400	991	739	96.10	0.86	993	704	96.40	0.82	1193	3202	619	96.60	0.84
PLSES 355LB	450	991	830	96.20	0.86	993	791	96.50	0.82	1193	3602	695	96.70	0.84
PLSES 355LC	500	991	926	96.50	0.85	993	887	96.80	0.81	1193	4002	779	97.10	0.83
PLSES 355LD	560	991	1050	96.50	0.84	993	1006	96.80	0.80	1193	4482	884	97.00	0.82
PLSES 400LB	630	992	1187	96.00	0.86	994	1086	96.10	0.86	1193	5043	1163	96.40	0.83
PLSES 400LD	710	993	1369	96.10	0.82	996	1316	96.20	0.76	1195	5865	1156	96.40	0.8

Electro_Motor.ir

IP23 DRIP-PROOF MOTORS

IMfinity® 3-phase induction motors - IE2 - IE3 - IE4 - Non IE Efficiency

IP23 Steel frame

Electrical and mechanical characteristics

IE3 - Powered by the drive

Type	400V / 50Hz				Rated torque M_n at S1 continuous duty					400V / 87Hz Δ				Maximum mechanical speed ¹
	Rated power	Rated speed	Rated current	Power factor	10Hz	17Hz	25Hz	50Hz	87Hz	Rated power	Rated speed	Rated current	Power factor	
	P_n kW	N_n min ⁻¹	I_n A	cos ϕ 4/4	N.m	N.m	N.m	N.m	N.m	P_n kW	N_n min ⁻¹	I_n A	cos ϕ 4/4	
2 poles														
PLSES 225 MG	75	2972	139	0.89	178	215	241	241	-	-	-	-	-	3600
PLSES 250 SF	90	2974	165	0.90	204	240	273	289	-	-	-	-	-	3600
PLSES 250 MF	110	2976	202	0.89	238	288	328	353	-	-	-	-	-	3600
PLSES 280 MD	132	2972	215	0.91	251	291	327	383	-	-	-	-	-	3600
PLSES 315 SU	160	2972	296	0.88	369	432	479	513	-	-	-	-	-	3600
PLSES 315 M	200	2980	383	0.85	421	494	560	641	-	-	-	-	-	3600
PLSES 315 L	250	2964	446	0.87	487	557	609	770	-	-	-	-	-	3600
PLSES 315 LD	280	2978	472	0.88	581	664	702	819	-	-	-	-	-	3600
PLSES 315 MGU	315	2972	575	0.90	759	860	1012	1012	-	-	-	-	-	3600
PLSES 315 LG	355	2977	648	0.90	855	969	1140	1140	-	-	-	-	-	3600
PLSES 315 LG	400	2977	735	0.90	1028	1157	1285	1285	-	-	-	-	-	3600
PLSES 315 VLG	450	2982	813	0.89	1090	1270	1448	1448	-	-	-	-	-	3600
PLSES 315 VLGU	500	2975	875	0.89	1130	1327	1525	1525	-	-	-	-	-	3600
PLSES 355 MA	500	2972	899	0.91	1124	1365	1606	1606	-	-	-	-	-	3600
PLSES 355 MB	560	2959	1020	0.90	1261	1531	1801	1802	-	-	-	-	-	3600
PLSES 355 MC	630	2958	1114	0.93	1422	1727	2032	2032	-	-	-	-	-	3600
PLSES 355 LA	710	2977	1267	0.91	1821	2049	2277	2277	-	-	-	-	-	3600
PLSES 355 LB	800	2974	1429	0.91	1790	2173	2429	2557	-	-	-	-	-	3600
4 poles														
PLSES 225 MG	55	1480	195	0.83	230	283	319	354	202	96	2570	195	0.83	3240
PLSES 250 SF	75	1484	155	0.83	314	386	435	483	278	131	2570	270	0.83	3240
PLSES 250 MF	90	1486	186	0.82	376	462	520	578	332	157	2574	323	0.82	3240
PLSES 280 SGJ	110	1490	214	0.85	602	706	706	706	402	191	2600	370	0.85	2700
PLSES 280 MG	132	1490	253	0.85	732	847	847	847	483	230	2600	438	0.85	2700
PLSES 315 SU	160	1488	320	0.83	721	824	927	1030	587	278	2577	558	0.83	3420
PLSES 315 MUR	200	1484	690	0.83	896	1032	1161	1290	730	348	2596	396	0.83	3420
PLSES 315 LUS	250	1486	499	0.83	1127	1288	1449	1610	925	435	2574	869	0.83	3420
PLSES 315 LG	280	1486	610	0.85	1440	1620	1797	1797	-	-	-	-	-	2610
PLSES 315 LG	315	1486	606	0.86	1395	1530	1800	2031	-	-	-	-	-	2610
PLSES 315 LG	355	1487	682	0.85	1745	1920	2280	2280	-	-	-	-	-	2610
PLSES 315 VLG	400	1486	756	0.84	1800	2190	2571	2571	-	-	-	-	-	2610
PLSES 315 VLGU	450	1487	850	0.86	2168	2312	2890	2890	-	-	-	-	-	2610
PLSES 355 MA	500	1489	917	0.89	2243	2724	3204	3204	-	-	-	-	-	2610
PLSES 355 MB	560	1487	1027	0.89	2516	3055	3594	3594	-	-	-	-	-	2610
PLSES 355 LA	630	1488	1157	0.89	2828	3434	4040	4040	-	-	-	-	-	2610
PLSES 355 LB	710	1487	1301	0.89	3194	3879	4564	4564	-	-	-	-	-	2610
PLSES 355 LC	750	1491	1387	0.88	3367	4089	4810	4810	-	-	-	-	-	2610
PLSES 400LB	800	1493	1526	0.86	4094	4606	5117	5117	-	-	-	-	-	1800
PLSES 400LB	900	1492	1739	0.85	5760	6480	7200	7200	-	-	-	-	-	1800
6 poles														
PLSES 355 LA	400	991	771	0.85	2503	3080	3850	3850	2195	-	-	-	-	1740
PLSES 355 LB	450	991	866	0.85	2816	3466	4332	4332	2469	-	-	-	-	1740
PLSES 355 LC	500	991	971	0.84	3129	3850	4813	4813	2743	-	-	-	-	1740
PLSES 355 LD	560	991	1101	0.83	3504	4312	5390	5390	3072	-	-	-	-	1740
PLSES 400LB	630	993	1140	0.86	6059	6816	7574	7574	-	-	-	-	-	1200
PLSES 400LD	710	994	1360	0.81	6821	7674	8526	8526	-	-	-	-	-	1200

(1) See Vibrations section on page 42

**DESCRIPTION TABLE OF TERMINAL BOXES FOR A 400 V RATED SUPPLY VOLTAGE
(in accordance with EN 50262)**

Series	Type	No. of poles	Terminal box material	Power + auxiliaries	
				Number of drill holes	Drill hole diameter
PLSES	225	2; 4	Aluminium alloy	3	2xM63 + 1xM16
	250	2; 4			
	280 MD/SD	2; 4		0	Removable undrilled mounting plate (see details page 145)
	280 SG/MG - 315 to 400	2; 4			

TERMINAL BLOCKS

DIRECTION OF ROTATION

Standard motors are fitted with a block of 6 terminals complying with standard NFC 51 120, with the terminal markings complying with IEC 60034-8 (or NF EN 60034-8).

When the motor is running in U1, V1, W1 or 1U, 1V, 1W from a direct mains supply L1, L2, L3, it turns clockwise when seen from the drive shaft end.

If any two of the phases are changed over, the motor will run in an anticlockwise direction (make sure that the motor has been designed to run in both directions).

If the motor is fitted with accessories (thermal protection or space heater), these must be connected on screw dominos with labelled wires.

Series	Type	230/400V connections		400/690V connections
		No. of poles	Terminals	Terminals
PLSES	225 MG	4	M10	M8
	225 MG	2	M12	M10
	250 MF	2; 4	M12	M10
	280	2; 4	M16	M12
	315 SU/MU/SUR/MUR/M	4	M16	M12
	315 L/LD/LU/LUS	2; 4	M16	M16
	315 VLG/LG/MGU	2; 4	M12	M12
	315 VLGU	2; 4	M12	M12
	355	2; 4	M14	M14
	355 LA	2	M14	M14
	355 LA	6	M14	M14
	355 LB	2	M14	M14
	355 LB	4	M14	M14
	355 LB	6	M14	M14
	355 LC	2	M14	M14
	400	4; 6	M14	M14

Tightening torque for the nuts on the terminal blocks.

Terminal	M8	M10	M12	M14	M16
Torque N.m	10	20	35	50	65

IMfinity® 3-phase induction motors - IE2 - IE3 - IE4 - Non IE Efficiency

IP23 Steel frame

Dimensions

Shaft extensions

Dimensions in millimetres

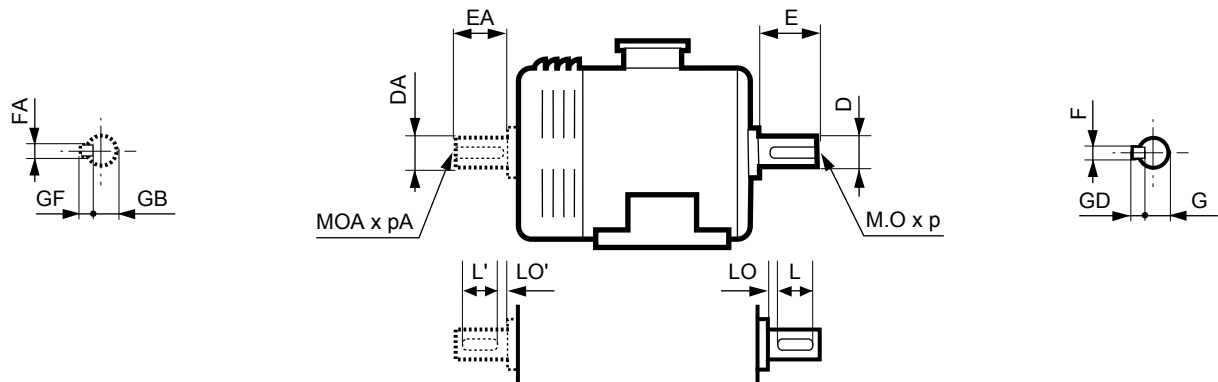

Type	Main shaft extensions																	
	4 and 6 poles									2 poles								
	F	GD	D	G	E	O	p	L	LO	F	GD	D	G	E	O	p	L	LO
PLSES 225 MG	18	11	65m6	58	140	M20	42	125	15	18	11	60m6	53	140	M20	42	125	15
PLSES 250 MF/SF	20	12	75m6	67.5	140	M20	42	125	15	18	11	65m6	58	140	M20	42	125	15
PLSES 280 MD	22	14	80m6	71	170	M20	42	140	30	18	11	65m6	58	140	M20	42	125	15
PLSES 280 MG/SGJ	22	14	80m6	71	170	M20	42	140	30	-	-	-	-	-	-	-	-	-
PLSES 315 L/M/MU/SU	25	14	90m6	81	170	M24	50	140	30	20	12	70m6	62.5	140	M20	42	140	30
PLSES 315 LD/LG/MGU/VLG/VLGU	28	16	100m6	90	210	M24	50	180	30	22	14	80m6	71	170	M20	42	140	30
PLSES 315 LU	28	16	100m6	90	210	M24	50	180	30	20	12	70m6	62.5	140	M20	42	140	30
PLSES 315 LUS/MUR/SUR	25	14	90m6	81	170	M24	50	140	30	-	-	-	-	-	-	-	-	-
PLSES 355 LA/LB/MA/MB	28	16	110m6	100	210	M24	50	180	30	22	14	80m6	71	170	M20	42	140	30
PLSES355 LC/LD	28	16	110m6	100	210	M24	50	180	30	-	-	-	-	-	-	-	-	-
PLSES355 MC	-	-	-	-	-	-	-	-	-	22	14	80m6	71	170	M20	42	140	30
PLSES 400 LB	32	18	120m6	109	210	24	50	-	-	-	-	-	-	-	-	-	-	-
PLSES 400 LD	32	18	120m6	109	210	24	50	-	-	-	-	-	-	-	-	-	-	-

Type	Secondary shaft extensions																	
	4 and 6 poles									2 poles								
	FA	GF	DA	GB	EA	OA	Pa	L'	LO'	FA	GF	DA	GB	EA	OA	Pa	L'	LO'
PLSES 225 MG	18	11	65m6	58	140	M20	42	125	15	18	11	60m6	53	140	M20	42	125	15
PLSES 250 MF/SF	18	11	65m6	58	140	M20	42	125	15	18	11	65m6	58	140	M20	42	125	15
PLSES 280 MD	-	-	-	-	-	-	-	-	-	18	11	65m6	58	140	M20	42	125	15
PLSES 280 MG/SGJ	18	11	65m6	58	140	M20	42	125	15	-	-	-	-	-	-	-	-	-
PLSES 315 L/LD/M	-	-	-	-	-	-	-	-	-	20	12	70m6	62.5	140	M20	42	125	15
PLSES 315 LG/LU/MGU/MU/SU	20	12	75m6	67.5	140	M20	42	125	15	20	12	70m6	62.5	140	M20	42	125	15
PLSES 315 LUS/MUR/SUR	20	12	75m6	67.5	140	M20	42	125	15	-	-	-	-	-	-	-	-	-
PLSES 315 VLG/VLGU	22	14	80m6	71	170	M20	42	140	30	22	14	80m6	71	170	M20	42	140	30
PLSES 355 LA/LB/MA/MB	18	11	65m6	58	140	M20	42	125	15	18	11	65m6	58	140	M20	42	125	15
PLSES355 LC/LD	18	11	65m6	58	140	M20	42	125	15	-	-	-	-	-	-	-	-	-
PLSES355 MC	-	-	-	-	-	-	-	-	-	18	11	65m6	58	140	M20	42	125	15
PLSES 400 LB	32	18	120m6	109	210	24	50	-	-	-	-	-	-	-	-	-	-	-
PLSES 400 LD	32	18	120m6	109	210	24	50	-	-	-	-	-	-	-	-	-	-	-

Electro_Motor.ir

IMfinity® 3-phase induction motors - IE2 - IE3 - IE4 - Non IE Efficiency
 IP23 Steel frame
Dimensions
 Foot mounted IM 1001 (IM B3)

Dimensions in millimetres

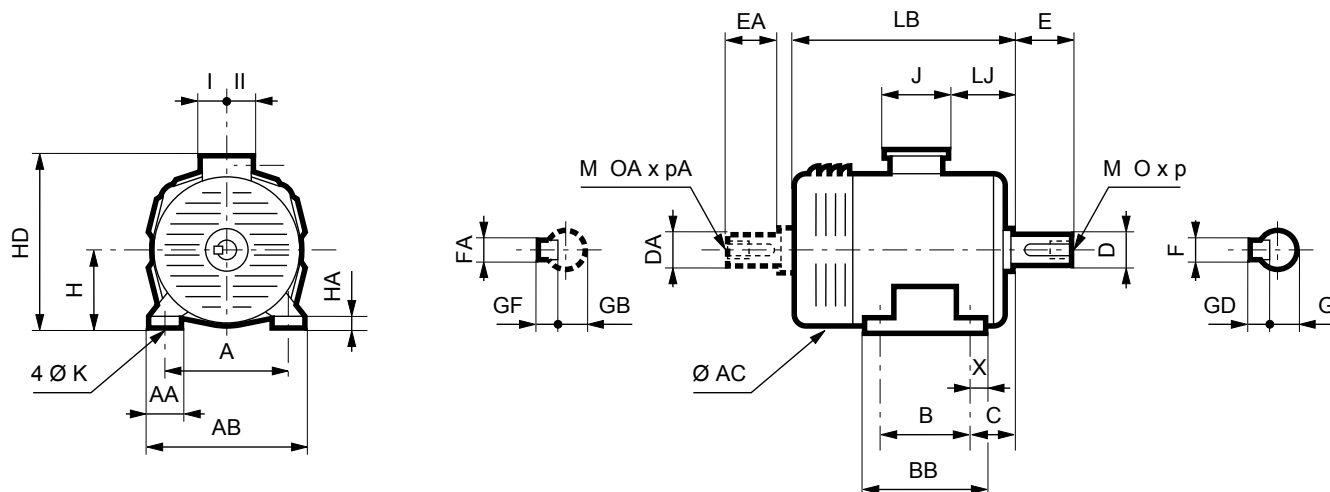

Type	Main dimensions																
	A	AB	B	BB	C	X	AA	K	HA	H	AC*	HD	LB	LJ	J	I	II
PLSES 225MG	356	416	311	351	149	20	60	19	26	225	443	629	824	209	292	151	181
PLSES 250MF	406	466	349	397	168	24	60	24	26	250	443	654	904	209	292	151	181
PLSES 250SF	406	466	349	397	168	24	60	24	26	250	443	654	904	209	292	151	181
PLSES 280MD	457	517	419	467	190	24	60	24	26	280	443	684	904	209	292	151	181
PLSES 280MG	457	537	419	499	190	40	80	24	27	280	548	830	940	241.5	420	180	233
PLSES 280SGJ	457	537	419	499	190	40	80	24	27	280	548	830	940	241.5	420	180	233
PLSES 315L	508	608	508	588	216	40	100	28	26	315	548	865	1026	241.5	420	180	233
PLSES 315LD	508	608	508	588	216	40	100	28	26	315	548	865	1085	241.5	420	180	233
PLSES 315LG	508	608	508	588	216	40	100	27	26	315	624	880	1261	247	428	206	206
PLSES 315LU	508	608	508	588	216	40	100	28	26	315	548	865	1106	241.5	420	180	233
PLSES 315LUS	508	608	508	588	216	40	100	28	26	315	548	865	1106	241.5	420	180	233
PLSES 315M	508	608	457	537	216	40	100	28	26	315	600	865	940	241.5	420	180	233
PLSES 315MGU	508	608	457	588	216	40	100	27	26	315	624	880	1261	247	428	206	206
PLSES 315MU	508	608	457	537	216	40	100	28	26	315	600	865	1025	241.5	420	180	233
PLSES 315MUR	508	608	457	537	216	40	100	28	26	315	600	865	1025	241.5	420	180	233
PLSES 315SU	508	608	406	486	216	40	100	28	26	315	600	865	940	241.5	420	180	233
PLSES 315SUR	508	608	406	486	216	40	100	28	26	315	600	865	1025	241.5	420	180	233
PLSES 315VLG	508	608	560	640	216	40	100	27	26	315	624	880	1321	248	428	206	206
PLSES 315VLGU	508	608	560	640	216	40	100	27	26	315	624	880	1391	248	428	206	206
PLSES 355LA	610	710	800	880	254	45	100	28	26	355	681	1094	1710	96	700	224	396
PLSES 355LB	610	710	800	880	254	45	100	28	26	355	681	1094	1710	96	700	224	396
PLSES 355LC	610	710	800	880	254	45	100	28	26	355	681	1094	1710	96	700	224	396
PLSES 355LD	610	710	800	880	254	45	100	28	26	355	681	1094	1710	96	700	224	396
PLSES355MA	610	710	630	710	254	45	100	28	26	355	681	1094	1480	96	700	224	396
PLSES355 MB	610	710	630	710	254	45	100	28	26	355	681	1094	1480	96	700	224	396
PLSES355 MC	610	710	630	710	254	45	100	28	26	355	681	1094	1480	96	700	224	396
PLSES 400 LB	686	806	710	800	280	45	120	35	26	400	795	1173	1755	177	700	224	396
PLSES 400 LD	686	806	710	800	280	45	120	35	26	400	795	1173	1755	177	700	224	396

* AC: housing diameter without lifting rings

Electro_Motor.ir

IP23 DRIP-PROOF MOTORS

IMfinity® 3-phase induction motors - IE2 - IE3 - IE4 - Non IE Efficiency
 IP23 Steel frame
Dimensions
 Foot and flange mounted IM 2001 (IM B35)

Dimensions in millimetres

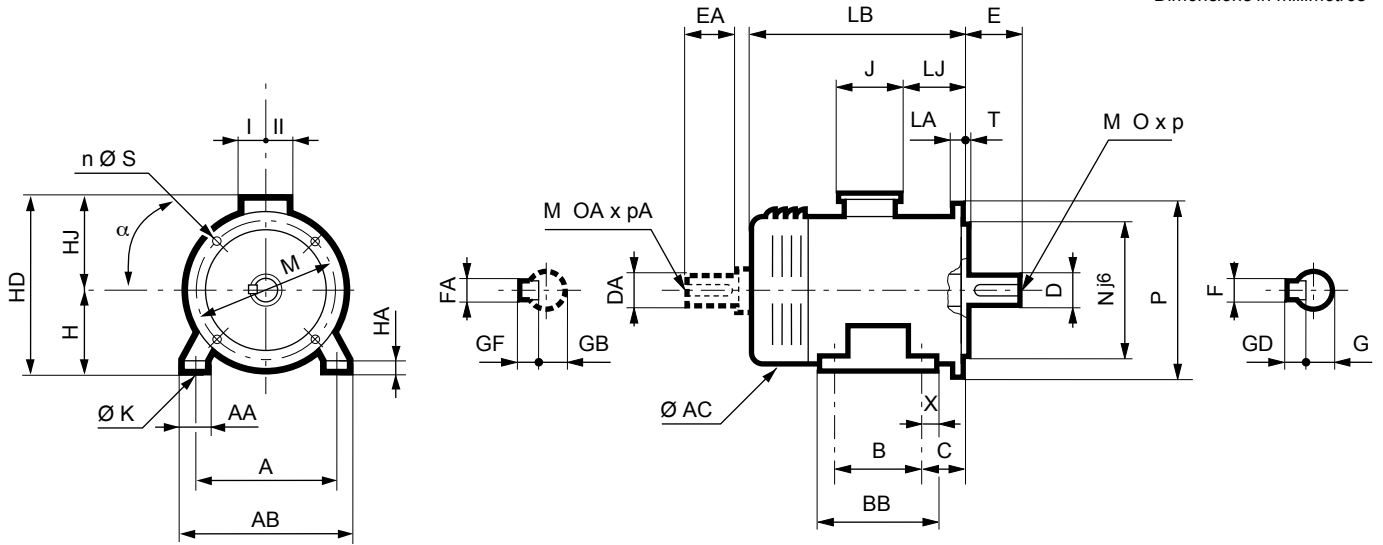

Type	Main dimensions																	
	A	AB	B	BB	C	X	AA	K	HA	H	AC*	HD	LB	LJ	J	I	II	Symb
PLSES 225 MG	356	416	311	351	149	20	60	19	26	225	443	629	824	209	292	151	181	FF500
PLSES 250 MF	406	466	349	397	168	24	60	24	26	250	443	654	904	209	292	151	181	FF600
PLSES 250 SF	406	466	349	397	168	24	60	24	26	250	443	654	904	209	292	151	181	FF600
PLSES 280 MD	457	517	419	467	190	24	60	24	26	280	443	684	904	209	292	151	181	FF600
PLSES 280 MG	457	537	419	499	190	40	80	24	27	280	548	830	940	241.5	420	180	233	FF600
PLSES 280 SGJ	457	537	419	499	190	40	80	24	27	280	548	830	940	241.5	420	180	233	FF600
PLSES 315 L	508	608	508	588	216	40	100	28	26	315	548	865	1026	241.5	420	180	233	FF740
PLSES 315 LD	508	608	508	588	216	40	100	28	26	315	548	865	1085	241.5	420	180	233	FF740
PLSES 315 LG	508	608	508	588	216	40	100	27	26	315	624	880	1261	247	428	206	206	FF740
PLSES 315 LU	508	608	508	588	216	40	100	28	26	315	548	865	1106	241.5	420	180	233	FF740
PLSES 315 LUS	508	608	508	588	216	40	100	28	26	315	548	865	1106	241.5	420	180	233	FF740
PLSES 315 M	508	608	457	537	216	40	100	28	26	315	600	865	940	241.5	420	180	233	FF740
PLSES 315 MGU	508	608	457	588	216	40	100	27	26	315	624	880	1261	247	428	206	206	FF740
PLSES 315 MU	508	608	457	537	216	40	100	28	26	315	600	865	1025	241.5	420	180	233	FF740
PLSES 315 MUR	508	608	457	537	216	40	100	28	26	315	600	865	1025	241.5	420	180	233	FF740
PLSES 315 SU	508	608	406	486	216	40	100	28	26	315	600	865	940	241.5	420	180	233	FF740
PLSES 315 SUR	508	608	406	486	216	40	100	28	26	315	600	865	1025	241.5	420	180	233	FF740
PLSES 315 VLG	508	608	560	640	216	40	100	27	26	315	624	880	1321	248	428	206	206	FF740
PLSES 315 VLGU	508	608	560	640	216	40	100	27	26	315	624	880	1391	248	428	206	206	FF740
PLSES 355LA	610	710	800	880	254	45	100	28	26	355	681	1094	1710	96	700	224	396	FF940
PLSES 355LB	610	710	800	880	254	45	100	28	26	355	681	1094	1710	96	700	224	396	FF940
PLSES 355LC	610	710	800	880	254	45	100	28	26	355	681	1094	1710	96	700	224	396	FF940
PLSES 355LD	610	710	800	880	254	45	100	28	26	355	681	1094	1710	96	700	224	396	FF940
PLSES355MA	610	710	630	710	254	45	100	28	26	355	681	1094	1480	96	700	224	396	FF940
PLSES355MB	610	710	630	710	254	45	100	28	26	355	681	1094	1480	96	700	224	396	FF940
PLSES355MC	610	710	630	710	254	45	100	28	26	355	681	1094	1480	96	700	224	396	FF940
PLSES 400 LB	686	806	710	800	280	45	120	35	26	400	795	1173	1755	177	700	224	396	FF 940
PLSES 400 LD	686	806	710	800	280	45	120	35	26	400	795	1173	1755	177	700	224	396	FF 940

Note: For frame size ≥ 250 mm used as IM B5 (IM 3001), please consult Nidec Leroy-Somer.

* AC: housing diameter without lifting rings

IEC symbol	Flange dimensions							
	M	N	P	T	n	α°	s	LA
FF 400	400	350	450	5	8	22.5	18.5	16
FF 500	500	450	550	5	8	22.5	18.5	18
FF 600	600	550	660	6	8	22.5	22	25
FF 740	740	680	800	6	8	22.5	22	25
FF 940	940	880	1000	6	8	22.5	28	28

Electro_Motor.ir

IMfinity® 3-phase induction motors - IE2 - IE3 - IE4 - Non IE Efficiency

IP23 Steel frame

Dimensions

Flange mounted IM 3001 (IM B5) IM 3011 (IM V1)

Dimensions in millimetres

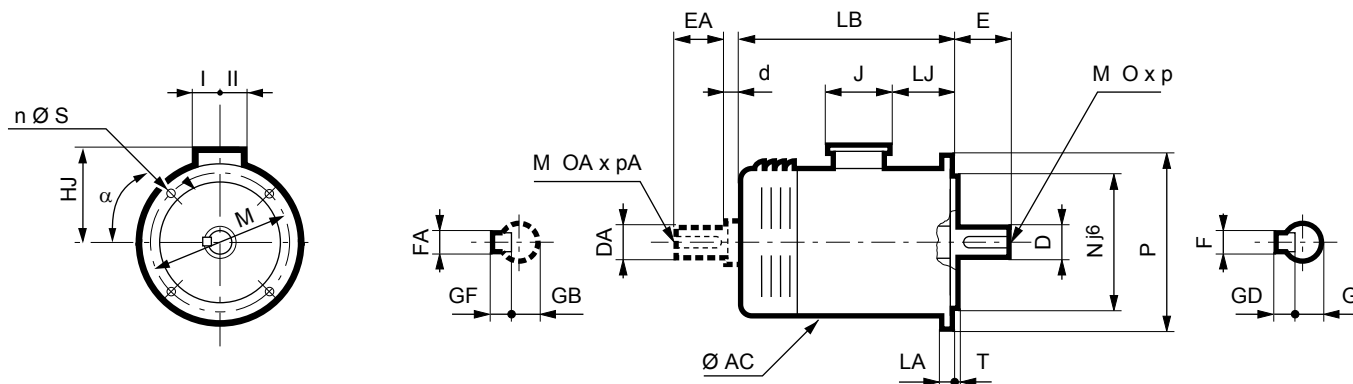

Type	Main dimensions								Symb
	AC*	HJ	LB	LJ	J	I	II		
PLSES 225 MG	443	824	404	209	292	151	181	FF500	
PLSES 250 MF	443	904	404	209	292	151	181	FF600	
PLSES 250 SF	443	904	404	209	292	151	181	FF600	
PLSES 280 MD	443	904	404	209	292	151	181	FF600	
PLSES 280 MG	548	964	550	265.5	420	180	233	FF600	
PLSES 280 SGJ	548	964	550	265.5	420	180	233	FF600	
PLSES 315 L	548	1026	550	241.5	420	180	233	FF740	
PLSES 315 LD	600	1085	550	241.5	420	180	233	FF740	
PLSES 315 LG	660	1261	565	248	428	206	206	FF740	
PLSES 315 LU	548	1106	550	241.5	420	180	233	FF740	
PLSES 315 LUS	548	1106	550	241.5	420	180	233	FF740	
PLSES 315 M	600	940	550	241.5	420	180	233	FF740	
PLSES 315 MGU	660	1261	565	248	428	206	206	FF740	
PLSES 315 MU	600	1025	550	241.5	420	180	233	FF740	
PLSES 315 MUR	600	1025	550	241.5	420	180	233	FF740	
PLSES 315 SU	600	940	550	241.5	420	180	233	FF740	
PLSES 315 SUR	600	1025	550	241.5	420	180	233	FF740	
PLSES 315 VLG	660	1321	565	248	428	206	206	FF740	
PLSES 315 VLGU	660	1391	565	248	428	206	206	FF740	
PLSES 355LA	681	1710	739	406	700	224	396	FF940	
PLSES 355LB	681	1710	739	406	700	224	396	FF940	
PLSES 355LC	681	1710	739	406	700	224	396	FF940	
PLSES 355LD	681	1710	739	406	700	224	396	FF940	
PLSES355 MA	681	1480	739	406	700	224	396	FF940	
PLSES355 MB	681	1480	739	406	700	224	396	FF940	
PLSES355 MC	681	1480	739	406	700	224	396	FF940	
PLSES 400 LB	795	773	1755	177	700	224	396	FF 940	
PLSES 400 LD	795	773	1755	177	700	224	396	FF 940	

Note: For frame size ≥ 250 mm used as IM B5 (IM 3001), please consult Nidec Leroy-Somer.

* AC: housing diameter without lifting rings

IEC symbol	Flange dimensions							
	M	N	P	T	n	α°	s	LA
FF 400	400	350	450	5	8	22.5	18.5	16
FF 500	500	450	550	5	8	22.5	18.5	18
FF 600	600	550	660	6	8	22.5	22	25
FF 740	740	680	800	6	8	22.5	22	25
FF 940	940	880	1000	6	8	22.5	28	28
FF 940	940	880	1000	6	8	22.5	28	28
FF 940	940	880	1000	6	8	22.5	28	28
FF 940	940	880	1000	6	8	22.5	28	28
FF 940	940	880	1000	6	8	22.5	28	28
FF 940	940	880	1000	6	8	22.5	28	28

Electro_Motor.ir

IP23 DRIP-PROOF MOTORS

BEARING WITH GREASE NIPPLES

The chart opposite shows the greasing intervals, depending on the type of motor, for standard bearing assemblies of frame size ≥ 250 mm fitted with grease nipples, operating at an ambient temperature of 25°C, 40°C and 55°C on a horizontal shaft machine.

The chart below is valid for **PLSES motors lubricated with Polyrex EM103 grease, which is used as standard.**

SPECIAL CONSTRUCTION AND ENVIRONMENT

For vertical shaft machines, the greasing intervals will be approximately 80% of the values stated in the table below.

Note: The quality and quantity of grease and the greasing interval are shown on the machine nameplate.

For special assemblies (motors fitted with DE roller bearings or other types), machines of frame size ≥ 160 mm have bearings with grease nipples.

Instructions for bearing maintenance are given on the nameplates on these machines.

Series	Type	No. of poles	Type of bearing for bearings with grease nipples*		Quantity of grease g	Greasing intervals in hours								
			N.D.E.	D.E.		3000 min ⁻¹			1500 min ⁻¹			1000 min ⁻¹		
						25°C	40°C	55°C	25°C	40°C	55°C	25°C	40°C	55°C
PLSES	225 MG	2; 4	6314 C3	6317 C3	40	8000	4000	2000	19600	9800	4900	-	-	-
	250 SF	2; 4			40									
	250 MF	2; 4			40									
	280 MD	2			40									
	280 SGJ	4	6320 C3	6320 C3	50	-	-	-	15800	7900	3950	-	-	-
	280 MG	4			50									
	280 SGU	4			50									
	280 MGU	4			50									
	315 SUR	4			50									
	315 MUR	4			50									
	315 LUS	4			50									
	315 SU	2			50									
	315 MU	2			50									
	315 L	2			35									
	315 LU	4	6224 C3	45	-	-	-	9000	4500	2250	-	-	-	
	315 LD	2	6219 C3	35	8000	4000	2000	-	-	-	-	-	-	
	315 LG/MGU	4	6317 C3	6317 C3	35	6500	6500	4095	-	-	-	-	-	-
	315 VLG/VLGU	2	6317 C3	6317 C3	35	6500	6500	4095	13200	13200	8316	-	-	-
		4	6317 C3	6322 C3	55	-	-	-	13200	13200	8316	-	-	-
		2	6317 C3	6317 C3	35	6500	6500	4095	-	-	-	-	-	-
		4	6324 C3	6324 C3	72	-	-	-	7500	3700	2800	-	-	-
	355 L	4	6317 C4	6317 C4	35	6500	6500	4095	-	-	-	-	-	-
	355 LA	2	6324 C3	6324 C3	72	-	-	-	-	-	-	20000	20000	20000
	355 LA	6	6317 C4	6317 C4	35	6500	6500	4095	-	-	-	-	-	-
355 LB	2	6324 C3	6324 C3	72	-	-	-	-	-	-	-	-	-	
355 LB	4	6317 C4	6317 C4	35	6500	6500	4095	-	-	-	-	-	-	
355 LB	6	6324 C3	6324 C3	72	-	-	-	7500	3700	2800	-	-	-	
355 LC	2	6317 C4	6317 C4	35	6500	6500	4095	-	-	-	-	-	-	
400 LB	4	6328 C3	6328 C3	93	-	-	-	4600	2300	1100	-	-	-	
400 LB	6			93	-	-	-	-	-	-	18200	18200	18500	
400 LD	6			93	-	-	-	-	-	-	18200	18200	18500	

* bearing with grease nipples on request

STANDARD BEARING FITTING ARRANGEMENTS

PLSES series		Horizontal shaft	Vertical shaft	
Foot mounted motors	Mounting arrangement		Shaft facing down	Shaft facing up
	Foot mounted motors	standard mounting	B3	V5
standard mounting		DE bearing locked	DE bearing locked	DE bearing locked
Flange mounted motors (or foot and flange)	Mounting arrangement	B5 / B35	V1 / V15	V3 / V36
	standard mounting	DE bearing locked	DE bearing locked	DE bearing locked

Electro_Motor.ir

HORIZONTAL MOTOR

For a bearing life L_{10h}
of 25,000 hours
and 40,000 hours



Series	Type	No. of poles	Permissible axial load (in daN) on main shaft extension for standard bearing assembly													
			3000 min ⁻¹						1500 min ⁻¹				1000 min ⁻¹			
			→		←		→		←		→		←			
			25,000 hours	40,000 hours	25,000 hours	40,000 hours	25,000 hours	40,000 hours	25,000 hours	40,000 hours	25,000 hours	40,000 hours	25,000 hours	40,000 hours		
PLSES	225 MG	2; 4	474	390	394	310	607	494	527	414	-	-	-	-		
	250 SF	2; 4	469	385	389	305	581	470	501	390	-	-	-	-		
	250 MF	2; 4	460	377	380	297	554	445	474	365	-	-	-	-		
	280 MD	2	375	292	455	372	-	-	-	-	-	-	-	-		
	280 SGJ	4	-	-	-	-	812	670	632	490	-	-	-	-		
	280 MG	4	-	-	-	-	809	666	629	486	-	-	-	-		
	280 SGU	4	-	-	-	-	798	656	618	476	-	-	-	-		
	280 MGU	4	-	-	-	-	794	652	614	472	-	-	-	-		
	315 L	2	457	380	277	200	-	-	-	-	-	-	-	-		
	315 LD	2	375	310	195	130	-	-	-	-	-	-	-	-		
	315 SU	2	472	395	292	215	-	-	-	-	-	-	-	-		
	315 MU	2; 4	460	383	280	203	783	642	603	462	-	-	-	-		
	315 M	2	469	391	289	211	-	-	-	-	-	-	-	-		
	315 SUR	4	-	-	-	-	787	645	607	465	-	-	-	-		
	315 MUR	4	-	-	-	-	763	623	583	443	-	-	-	-		
	315 LG/MGU	2; 4	504	417	364	277	860	703	720	563	-	-	-	-		
	315 LU	4	-	-	-	-	630	513	450	333	-	-	-	-		
	315 LUS	2; 4	758	618	578	438	755	615	575	435	-	-	-	-		
	315 VLG	2; 4	508	-	208	-	880	-	580	-	-	-	-	-		
	315 VLGU	2; 4	530	-	250	-	846	-	546	-	-	-	-	-		
	355 L	2; 4	135	-	415	-	414	-	694	-	-	-	-	-		
	355 LA/LB/LC	2	135	-	415	-	-	-	-	-	-	-	-	-		
	355 LB	4	-	-	-	-	414	-	694	-	-	-	-	-		
	355 LA/LB	6	-	-	-	-	-	-	-	-	600	-	907	-		
400 LB	4	-	-	-	-	552	-	906	-	-	-	-	-			
400 LB/LD	6	-	-	-	-	-	-	-	-	650	-	1020	-			

IP23 DRIP-PROOF MOTORS

**VERTICAL MOTOR
SHAFT FACING DOWN**

For a bearing life L_{10h}
of 25,000 hours
and 40,000 hours

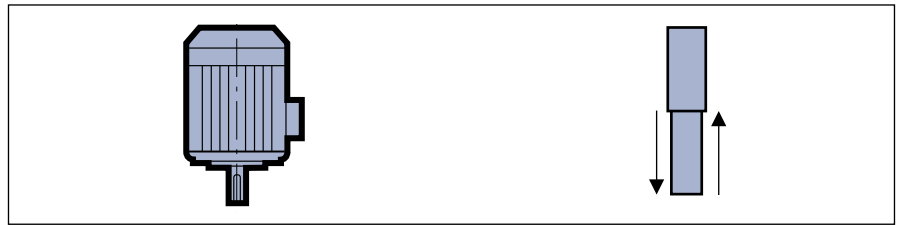

Series	Type	No. of poles	Permissible axial load (in daN) on main shaft extension for standard bearing assembly													
			3000 min ⁻¹						IM V5 IM V1 / V15 1500 min ⁻¹				1000 min ⁻¹			
			25,000 hours	40,000 hours	25,000 hours	40,000 hours	25,000 hours	40,000 hours	25,000 hours	40,000 hours	25,000 hours	40,000 hours	25,000 hours	40,000 hours		
PLSES	225 MG	2;4	400	315	506	421	506	392	684	570	-	-	-	-		
	250 SF	2;4	383	298	518	433	464	351	694	581	-	-	-	-		
	250 MF	2;4	365	280	529	444	432	320	691	579	-	-	-	-		
	280 MD	2	282	198	605	520	-	-	-	-	-	-	-	-		
	280 SGJ	4	-	-	-	-	640	495	901	756	-	-	-	-		
	280 MG	4	-	-	-	-	624	479	913	768	-	-	-	-		
	280 SGU	4	-	-	-	-	605	460	929	784	-	-	-	-		
	280 MGU	4	-	-	-	-	579	434	951	806	-	-	-	-		
	315 L	2	302	222	518	439	-	-	-	-	-	-	-	-		
	315 LD	2	196	129	482	415	-	-	-	-	-	-	-	-		
	315 LG/MGU	2;4	390	300	550	457	610	445	1124	957	-	-	-	-		
	315 SU	2	341	261	493	413	-	-	-	-	-	-	-	-		
	315 MU	2;4	316	236	507	428	568	424	944	800	-	-	-	-		
	315 M	2	337	258	489	410	-	-	-	-	-	-	-	-		
	315 SUR	4	-	-	-	-	575	427	947	803	-	-	-	-		
	315 MUR	4	-	-	-	-	522	378	978	834	-	-	-	-		
	315 LU	4	-	-	-	-	374	254	862	742	-	-	-	-		
	315 VLG	2;4	270	-	580	-	557	-	1085	-	-	-	-	-		
	315 VLGU	2;4	250	-	630	-	483	-	1125	-	-	-	-	-		
	315 LUS	2;4	503	359	991	847	514	370	973	829	-	-	-	-		
355 LA/LB/LC	2	402	-	396	-	-	-	-	-	-	-	-	-			
355 LB	4	-	-	-	-	573	-	893	-	-	-	-	-			
355 LA/LB	6	-	-	-	-	-	-	-	-	600	-	907	-			
400 LB	4	-	-	-	-	568	-	1309	-	-	-	-	-			
400 LB/LD	6	-	-	-	-	-	-	-	-	650	-	1020	-			

IP23 DRIP-PROOF MOTORS

**VERTICAL MOTOR
SHAFT FACING UP**

For a bearing life L_{10h}
of 25,000 hours
and 40,000 hours

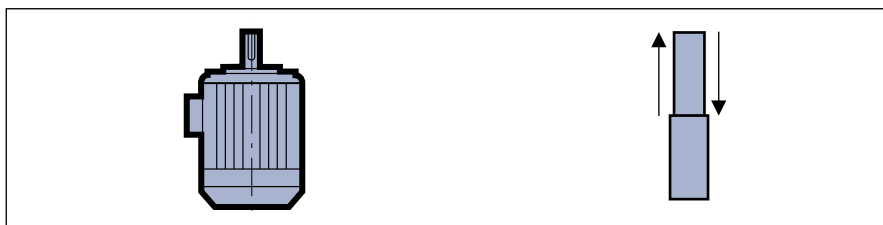

		Permissible axial load (in daN) on main shaft extension for standard bearing assembly									
		IM V6 IM V3 / V36									
Series	Type	No. of poles	3000 min ⁻¹				1500 min ⁻¹				
			25,000 hours	40,000 hours	25,000 hours	40,000 hours	25,000 hours	40,000 hours	25,000 hours	40,000 hours	
PLSES	225 MG	2 ; 4	320	235	586	501	426	312	764	650	
	250 SF	2 ; 4	303	218	598	513	384	661	774	271	
	250 MF	4	285	200	609	524	352	240	771	659	
	280 MD	2	362	278	525	440	-	-	-	-	
	280 SGJ	4	-	-	-	-	460	315	1081	936	
	280 MG	4	-	-	-	-	444	299	1093	948	
	280 SGU	4	-	-	-	-	425	280	1109	964	
	280 MGU	4	-	-	-	-	399	254	1131	986	
	315 L	2	122	42	698	619	-	-	-	-	
	315 LD	2	16	0	662	595	-	-	-	-	
	315 SU	2	161	81	673	593	-	-	-	-	
	315 MU	2 ; 4	136	56	687	608	388	244	1124	980	
	315 M	2	157	78	669	590	-	-	-	-	
	315 SUR	4	-	-	-	-	392	247	1127	983	
	315 MUR	4	-	-	-	-	342	198	1158	1014	
	315 LU	4	-	-	-	-	1042	922	194	74	
	315 LUS	2 ; 4	323	179	1171	1027	1153	1009	334	190	
	315 LG/MGU	2 ; 4	60	0	498	444	682	518	1011	848	
	315 VLG	2 ; 4	30	-	878	-	257	-	1385	-	
	315 VLGU	2 ; 4	260	-	630	-	183	-	1425	-	
355 L/LA/LB	2 ; 4	600	-	1396	-	427	-	1893	-		
400 LB	4	-	-	-	-	632	-	2570	-		

STANDARD FITTING ARRANGEMENT

Permissible radial load on main shaft extension with a bearing life L_{10h} of 25,000 hours.

FR : Radial Force

X: Distance with respect to the shaft shoulder

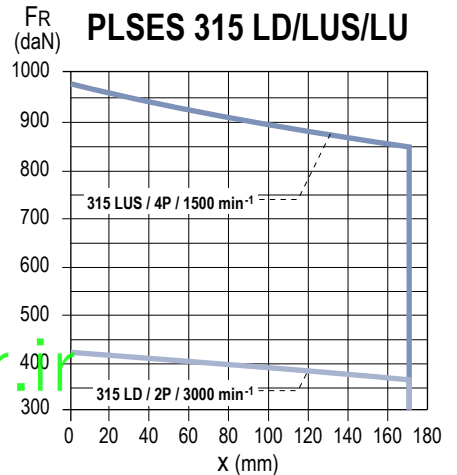
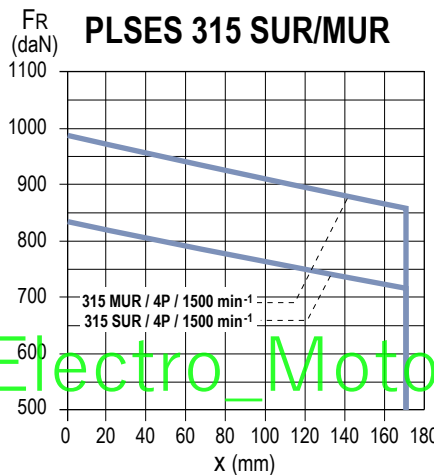
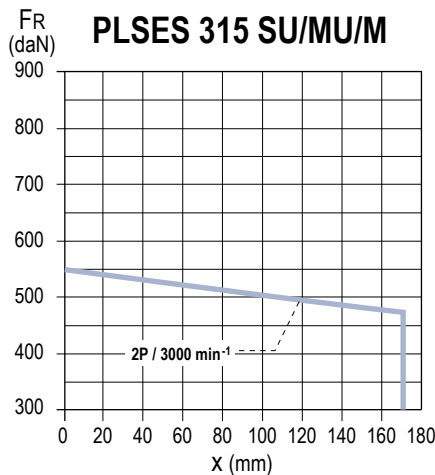
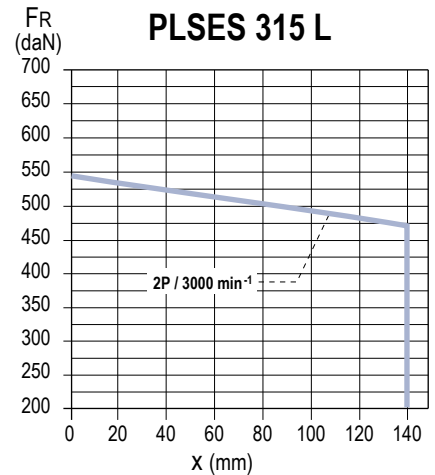
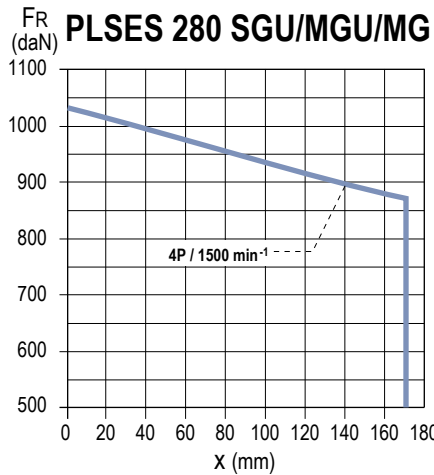
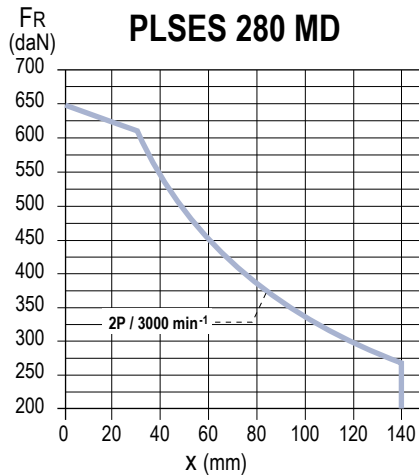
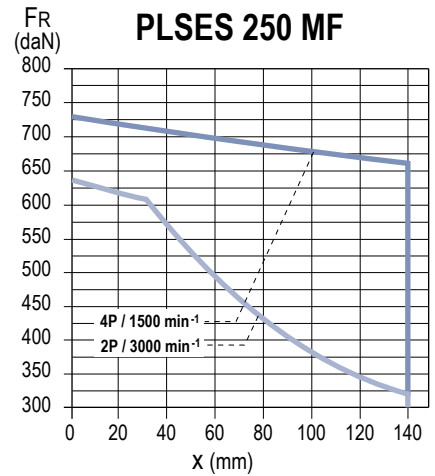
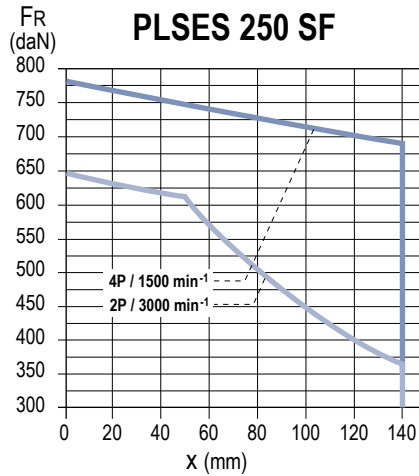
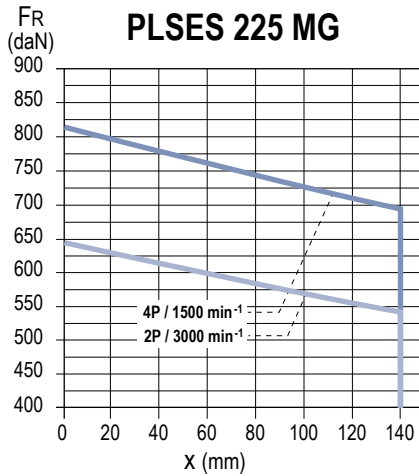

IP23 DRIP-PROOF MOTORS

Electro_Motor.ir

STANDARD FITTING ARRANGEMENT

Permissible radial load on main shaft extension with a bearing life L_{10h} of 25,000 hours.

FR: Radial Force

X: Distance with respect to the shaft shoulder

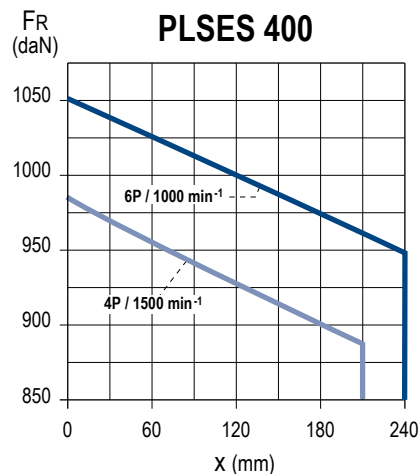
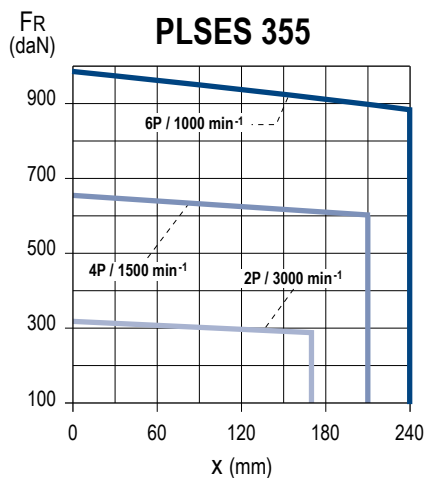
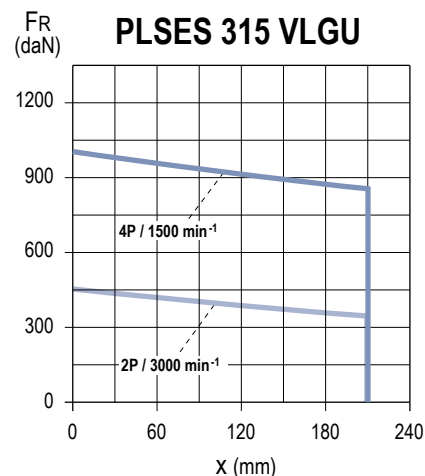
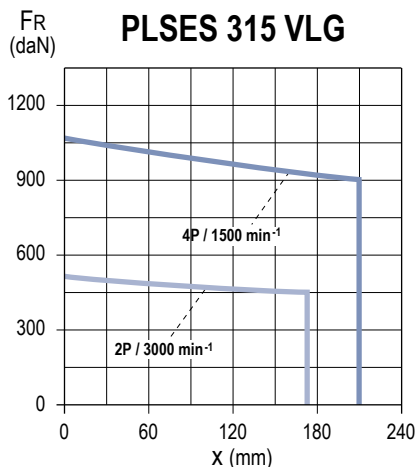
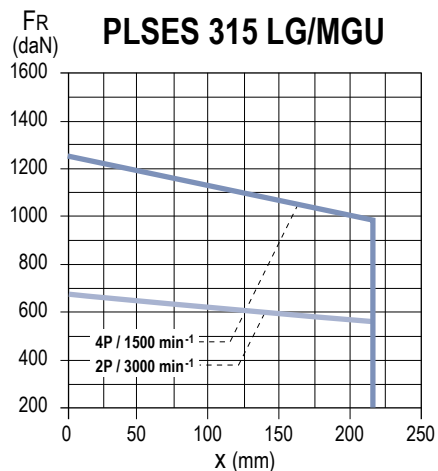

SPECIAL FITTING ARRANGEMENT

Type of drive end roller bearings

Series	Type	No. of poles	Non drive end bearing (N.D.E.)	Drive end bearing (D.E.)
PLSES	225 MG	4	6314 C3	NU 317
	250 SF	4		
	250 MF	4		
	280 MD	4		
	280 SGU/SGJ	4		
	280 MGU	4	6316 C3	NU 320
	315 SUR/SU	4		
	315 MUR	4		
	315 LUS	4		
	315 L	4		
	315 LD	4		
	315 LG/MGU	4		
	315 VLG/VLGU	4	6317 C3	NU 322
	355 LA	2	6317 C4	-
	355 LA	4 ; 6	6324 C3	NU 324
	355 LB	2	6317 C4	
	355 LB	4 ; 6	6324 C3	
	355 LC	2	6317 C4	-
	400 LA	4 ; 6	6328 C3	NU 328
	400 LB	4		
400 LB/LD	6			

SPECIAL FITTING ARRANGEMENT

Permissible radial load on main shaft extension with a bearing life L_{10h} of 25,000 hours.

FR: Radial Force

X: Distance with respect to the shaft shoulder

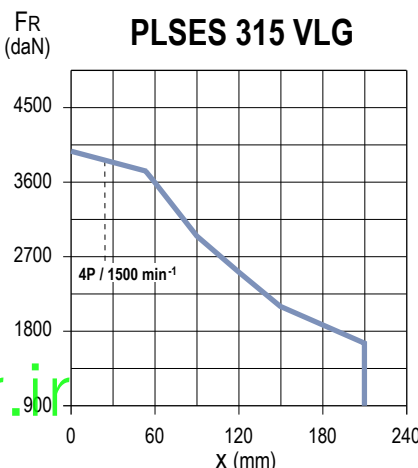
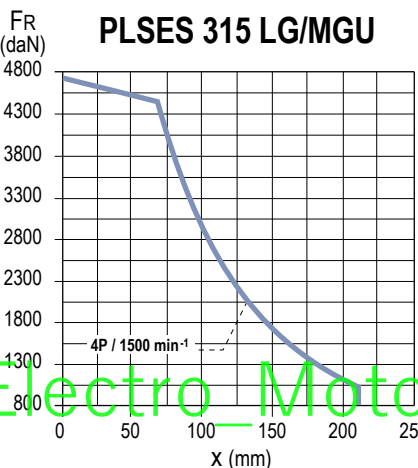
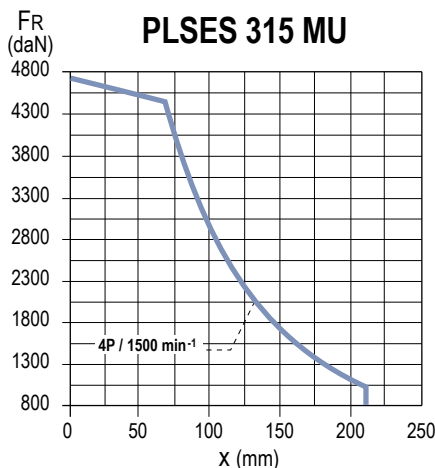
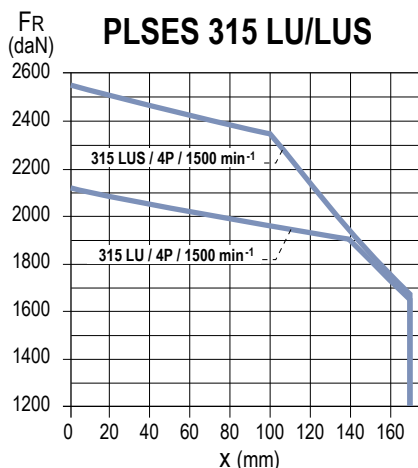
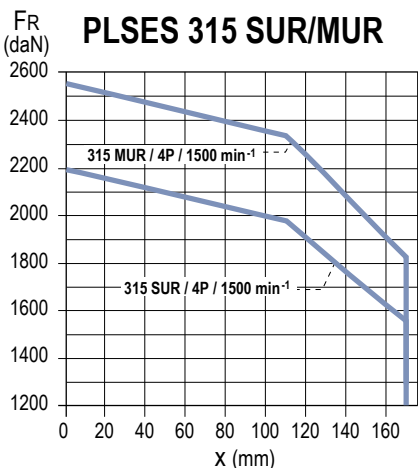
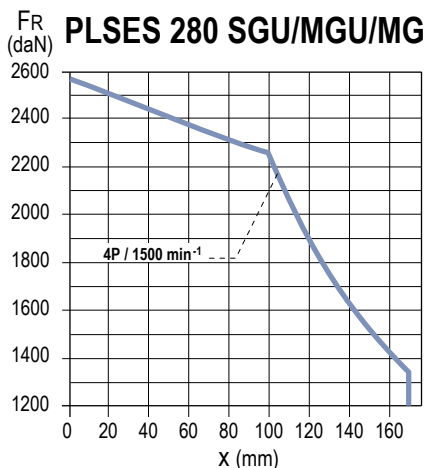
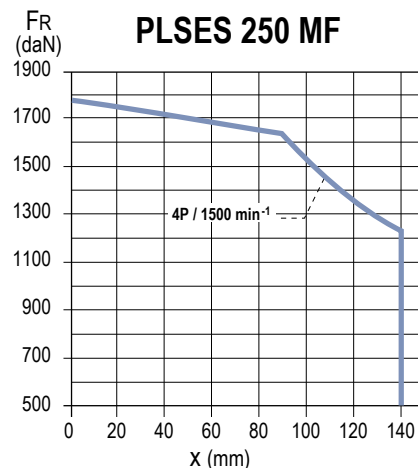
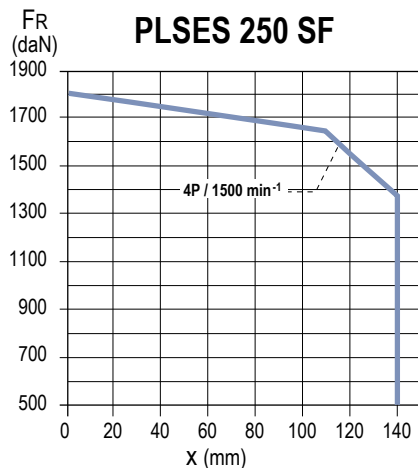
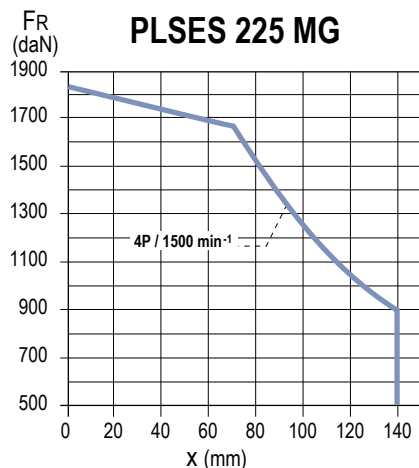

Electro Motor.ir

IP23 DRIP-PROOF MOTORS

SPECIAL FITTING ARRANGEMENT

Permissible radial load on main shaft extension with a bearing life L_{10h} of 25,000 hours.

FR: Radial Force

X: Distance with respect to the shaft shoulder

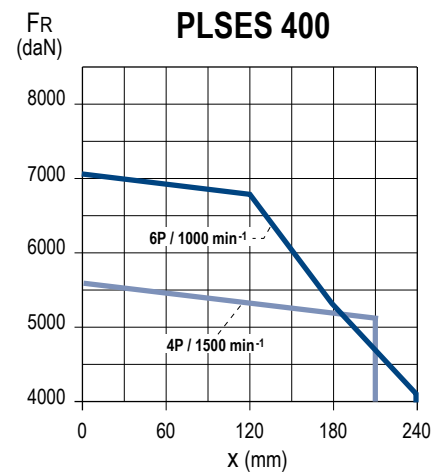
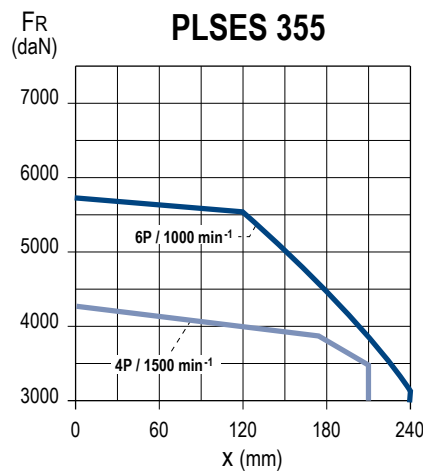
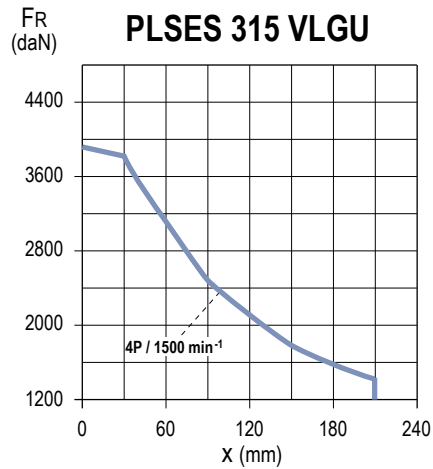

MODIFIED FLANGES

Motor type \ Flange type	(FF) Flange mounted							
	FF 300	FF 350	FF 400	FF 500	FF 600	FF 740	FF 940	FF 1080
PLSES 225 MG			◆	●				
PLSES 250 SP/MP/MF				◆	●			
PLSES 280 MD/MG/SGJ				◆	●			
PLSES 315 S/SUR/L/LD/M/MUR/LUS/SU					◆	●		
PLSES 315					◆	●		
PLSES 355						◆	●	
PLSES 400							●	◆

● Standard ◆ Adaptable without shaft modification

Mechanical and electrical options

MOTORS WITH SPACE HEATERS

Type	Power (W)
PLSES 225 to 280	84
PLSES 315	100
PLSES 355 / 400	200

The space heaters use 200/240 V single phase, 50 or 60 Hz.

LIFTING THE MOTOR ONLY
(not coupled to the machine)

The regulations stipulate that over 25 kg, suitable handling equipment must be used.

All our motors are fitted with grab handles, making them easier to handle without risk. A diagram of the sling hoisting method appears below with the required dimensions.

To prevent any damage to the motor during handling (for example: switching the motor from horizontal to vertical), it is essential to follow these instructions.

HORIZONTAL POSITION

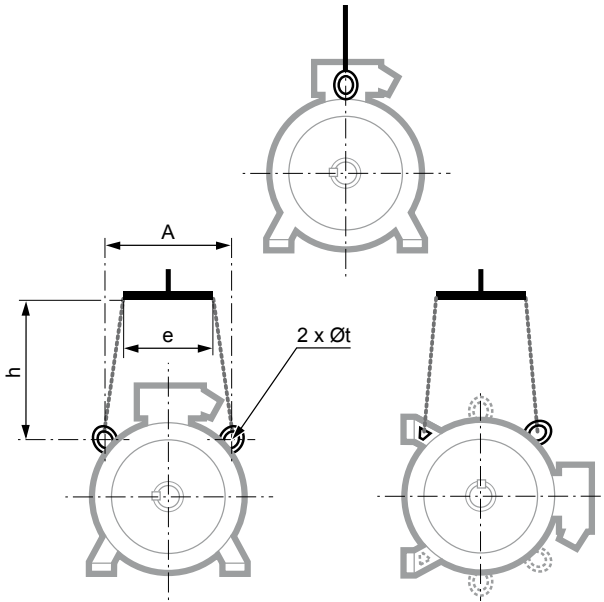

Type	Horizontal position			
	A	e min	h min	Øt
PLSES 225 MG	310	300	300	30
PLSES 250 MF/SF	310	300	300	30
PLSES 280 MD/MGU/SGU/SGJ	310	300	300	30
PLSES 315 SUR/MUR/L/LD/LUS/SU	385	380	500	30
PLSES 315 LG/MGU/VLG/VLGU	440	750	550	48
PLSES 355	504	850	630	67
PLSES 400	600	1010	750	67

VERTICAL POSITION

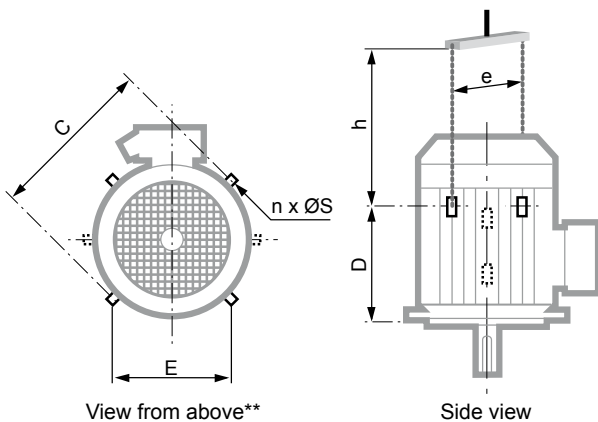

Type	Vertical position					
	C	E	n**	ØS	e min*	h min
PLSES 225 MG	450	310	2	14	450	490
PLSES 250 MF/SF	450	310	4	30	450	490
PLSES 280 MD/MGU/SGU/SGJ	450	310	4	30	450	490
PLSES 315 SUR/MUR/L/LD/LUS/SU	500	385	4	30	500	500
PLSES 315 LG/MGU/VLG/VLGU	610	440	8	48	750	450
PLSES 355	710	504	8	48	800	530
PLSES 400	850	600	8	67	900	640

* if the motor is fitted with a drip cover, allow an additional 50 to 100 mm to avoid damaging it when the load is swung.

** if n = 2, the lifting rings form an angle of 90° with respect to the axis of the terminal box.

If n = 4, this angle becomes 45°.

IP23 DRIP-PROOF MOTORS

Cable gland support plates

ZONES USED FOR DRILLING THE CABLE GLAND SUPPORT PLATES

Dimensions in millimetres

IP55 aluminium motors		
Motor type	Diagram	Without extension feed (standard)
LSES 315	4	H = 170 L = 333

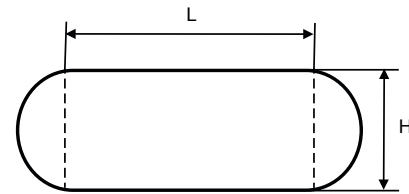

Diagram 1

IP55 cast iron motors		
Motor type	Diagram	Without extension feed (standard)
FLSES 160	3	H = 54 L = 131
FLSES 180		
FLSES 200		
FLSES 225 SR/MR	3	H = 80 L = 190
FLSES 225 S/M/SG		
FLSES 250	3	H = 80 L = 190
FLSES 280		
FLSES 315		
FLSES 355 L	1	H = 115 L = 125
FLSES 355 LK		
FLSES 400	2	H = 170 L = 460
FLSES 450		

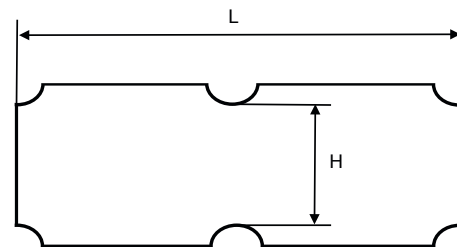

Diagram 2

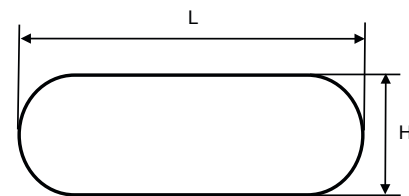

Diagram 3

IP23 drip-proof motors		
Motor type	Diagram	Without extension feed (standard)
PLSES 280 MGU/SGU	4	H = 170 L = 333
PLSES 315 L/LD/LUS/M/MUR		
PLSES 315 MU/S/SU/SUR		
PLSES 315 LG/MGU/VLG/VLGU	1	H = 115 L = 125
PLSES 355		
PLSES 400	2	H = 170 L = 460

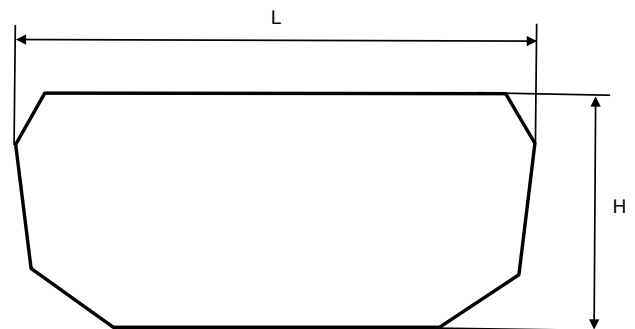

Diagram 4

Calculating the efficiency of an induction motor

MACHINE EFFICIENCY

Efficiency is the ratio between the output power (needed to drive a machine) and the power absorbed (power consumed). This value is therefore necessarily less than 1. The difference between the output power and the power absorbed consists of the electrical machine losses. 85% efficiency therefore means there are 15% losses.

Direct measurement method

With the direct method, efficiency is calculated using mechanical (torque C and speed Ω) and electrical (power absorbed P_{abs}) measurements. If the measuring tools are specified (use of a torquemeter), this method has the advantage of being relatively easy. However, it does not provide any information about machine performance and the origins of the potential losses.

$$\eta = \frac{P_u}{P_{abs}} \text{ where } P_u = C \Omega$$

Indirect measurement methods

These methods determine efficiency by determining the machine losses. Conventionally, a distinction is made between three types of losses: joule losses (stator P_{js} and rotor P_{jr}), iron losses (P_f) and mechanical losses (P_m) which are relatively easy to measure. Miscellaneous losses which are more difficult to determine, called additional losses, are added to these losses.

Additional losses come from a variety of sources: surface losses, busbar currents, high-frequency losses, losses linked to leakage flux, etc. They are specific to each machine and contribute to reducing efficiency but they are very complex to calculate from a quantitative point of view.

$$\eta = \frac{P_{abs} - P_{js} - P_{jr} - P_f - P_m - P_{sup}}{P_{abs}}$$

Those additional losses can be calculated in 2 ways define in the standard IEC 60034-2-1, June 2014:

- 1/ they can be calculated based on a fixed percentage of 0.5% of the power absorbed,
- 2/ they can be precisely measured.

This is a similar approach to that taken by the North American (IEEE112-B) and Canadian (CSA390) standards, which deduct the additional losses from a thermally-stable on-load curve.

Units of measurement and standard formulae

ELECTRICITY AND ELECTROMAGNETISM

Parameters				Unit		Units and expressions not recommended
French name	English name	Symbol	Definition	SI	Non SI but accepted	Conversions
Fréquence Période	Frequency	f		Hz (hertz)		
Courant électrique (intensité de)	Electric current	I		A (ampere)		
Potentiel électrique Tension	Electric potential Voltage	V U		V (volt)		
Force électromotrice	Electromotive force	E				
Déphasage	Phase angle	φ		rad	° degree	
Facteur de puissance	Power factor	$\cos \varphi$				
Réactance Résistance	Reactance Resistance	X R		Ω (ohm)		j is defined as $j^2 = -1$ ω rotational frequency = $2 \pi \cdot f$
Impédance	Impedance	Z				
Inductance propre (self)	Self inductance	L		H (henry)		
Capacité	Capacitance	C		F (farad)		
Charge électrique, Quantité d'électricité	Quantity of electricity	Q		C (coulomb)	A.h 1 A.h = 3 600 C	
Résistivité	Resistivity	ρ		$\Omega \cdot m$		Ω/m
Conductance	Conductance	G		S (siemens)		$1/\Omega = 1 S$
Nombre de tours, (spires) de l'enroulement	N° of turns (coil)	N				
Nombre de phases	N° of phases	m				
Nombre de paires de poles	N° of pairs of poles	p				
Champ magnétique	Magnetic field	H		A/m		
Différence de potentiel magnétique Force magnétomotrice Solénation, courant totalisé	Magnetic potential difference Magnetomotive force	Um F, Fm H		A		The unit AT (ampere-turns) is incorrect because it treats "turn" as a physical unit
Induction magnétique, Densité de flux magnétique	Magnetic induction Magnetic flux density	B		T (tesla) = Wb/m ²		(gauss) 1 G = 10 ⁻⁴ T
Flux magnétique, Flux d'induction magnétique	Magnetic flux	Φ		Wb (weber)		(maxwell) 1 max = 10 ⁻⁸ Wb
Potentiel vecteur magnétique	Magnetic vector potential	A		Wb/m		
Perméabilité d'un milieu Perméabilité du vide	Permeability Permeability of vacuum	$\mu = \mu_0 \mu_r$ μ_0		H/m		
Permittivité	Permittivity	$\epsilon = \epsilon_0 \epsilon_r$		F/m		

Electro_Motor.ir

Units of measurement and standard formulae

THERMODYNAMICS

Parameters				Unit		Units and expressions not recommended
French name	English name	Symbol	Definition	SI	Non SI but accepted	Conversions
Température Thermodynamique	Temperature Thermodynamic	T		K (kelvin)	temperature Celsius, t , °C $T = t + 273,15$	°C: Degree Celsius t_C : Temp. in °C t_F : Temp. in °F f temperature Fahrenheit °F
Écart de température	Temperature rise	ΔT		K	°C	1 °C = 1 K
Densité de flux thermique	Heat flux density	q, φ		W/m ²		
Conductivité thermique	Thermal conductivity	λ		W/m.K		
Coefficient de transmission thermique global	Total heat transmission coefficient	K		W/m ² .K		
Capacité thermique	Heat capacity	C		J/K		
Capacité thermique massique	Specific heat capacity	c		J/kg.K		
Energie interne	Internal energy	U		J		

NOISE AND VIBRATION

Parameters				Unit		Units and expressions not recommended
French name	English name	Symbol	Definition	SI	Non SI but accepted	Conversions
Niveau de puissance acoustique	Sound power level	L_w	$L_w = 10 \lg(P/P_o)$ ($P_o = 10^{-12} W$)	dB (decibel)		\lg logarithm to base 10 $\lg 10 = 1$
Niveau de pression acoustique	Sound pressure level	L_p	$L_p = 20 \lg(P/P_o)$ ($P_o = 2 \times 10^{-5} Pa$)	dB		

DIMENSIONS

Parameters				Unit		Units and expressions not recommended
French name	English name	Symbol	Definition	SI	Non SI but accepted	Conversions
Angle (angle plan)	Angle (plane angle)	$\alpha, \beta, T, \varphi$		rad	degree: ° minute: ' second: ''	180° = π rad = 3.14 rad
Longueur Largeur Hauteur Rayon Longueur curviligne	Length Breadth Height Radius	l b h r s		m (metre)	micrometre	cm, dm, dam, hm 1 inch = 1" = 25.4 mm 1 foot = 1" = 304.8 mm μ m micron μ angström: A = 0.10 nm
Aire, superficie	Area	A, S		m ²		1 square inch = $6.45 \cdot 10^{-4} m^2$
Volume	Volume	V		m ³	litre: l liter: L	UK gallon = $4.546 \cdot 10^{-3} m^3$ US gallon = $3.785 \cdot 10^{-3} m^3$

Electro_Motor.ir

Units of measurement and standard formulae

MECHANICS

Parameters				Unit		Units and expressions not recommended
English name	French name	Symbol	Definition	SI	Non SI but accepted	Conversions
Time	Temps	t				
Period (periodic time)	Intervalle de temps, durée Période (durée d'un cycle)	T		s (second)	minute: min hour: h day: d	Symbols ' and " are reserved for angles minute not written as mn
Angular velocity Circular frequency	Vitesse angulaire Pulsation	ω	$\omega = \frac{d\varphi}{dt}$	rad/s		
Angular acceleration	Accélération angulaire	α	$\alpha = \frac{d\omega}{dt}$	rad/s ²		
Speed	Vitesse	$u, v, w,$	$v = \frac{ds}{dt}$			
Velocity	Célérité	c		m/s	1 km/h = 0.277 778 m/s 1 m/min = 0.016 6 m/s	
Acceleration	Accélération	a	$a = \frac{dv}{dt}$	m/s ²		
Acceleration of free fall	Accélération de la pesanteur	$g =$ $9.81m/s^2$	<i>in Paris</i>			
Revolution per minute	Vitesse de rotation	N		s ⁻¹	min ⁻¹	tr/mn, RPM, TM...
Mass	Masse	m		kg (kilogramme)	tonne: t 1 t = 1 000 kg	kilo, kgs, KG... 1 pound: 1 lb = 0.453 6 kg
Mass density	Masse volumique	ρ	$\frac{dm}{dV}$	kg/m ³		
Linear density	Masse linéique	ρ_e	$\frac{dm}{dL}$	kg/m		
Surface mass	Masse surfacique	ρ_A	$\frac{dm}{dS}$	kg/m ²		
Momentum	Quantité de mouvement	P	$p = m.v$	kg. m/s		
Moment of inertia	Moment d'inertie	J, I	$I = \sum m.r^2$	kg.m ²		$J = \frac{MD^2}{4}$ kg.m ² pound per square feet = 1 lb.ft ² = 42.1 x 10 ⁻³ kg.m ²
Force Weight	Force Poids	F G	$G = m.g$	N (newton)		kgf = kgp = 9.81 N pound force = lbf = 4.448 N
Moment of force, Torque	Moment d'une force	M T	$M = F.r$	N.m		mdaN, mkg, m.N 1 mkg = 9.81 N.m 1 ft.lbf = 1.356 N.m 1 in.lbf = 0.113 N.m
Pressure	Pression	p	$p = \frac{F}{S} = \frac{F}{A}$	Pa (pascal)	bar 1 bar = 10 ⁵ Pa	1 kgf/cm ² = 0.981 bar 1 psi = 6 894 N/m ² = 6 894 Pa 1 psi = 0.068 94 bar 1 atm = 1.013 x 10 ⁵ Pa
Normal stress Shear stress	Contrainte normale Contrainte tangentielle, Cission	σ τ		Pa we use MPa = 10 ⁶ Pa		kg/mm ² , 1 daN/mm ² = 10 MPa psi = pound per square inch 1 psi = 6 894 Pa
Friction coefficient	Facteur de frottement	μ				incorrectly = coefficient friction f
Work Energy Potential energy Kinetic energy Quantity of heat	Travail Énergie Énergie potentielle Énergie cinétique Quantité de chaleur	W E E_p E_k Q	$W = F.l$			
Power	Puissance	P	$P = \frac{W}{t}$	W (watt)	Wh = 3 600 J (watt hour)	1 N.m = 1 W.s = 1 J 1 kgm = 9.81 J (calorie) 1 cal = 4.18 J 1 kgm = 1.055 J (British thermal unit)
Volumetric flow	Débit volumique	q_v	$q_v = \frac{dV}{dt}$	m ³ /s		1 ch = 736 W 1 HP = 746 W
Efficiency	Rendement	η		< 1		%
Dynamic viscosity	Viscosité dynamique	η, μ		Pa.s		poise, 1 P = 0.1 Pa.s
Kinematic viscosity	Viscosité cinématique	ν	$\nu = \frac{\eta}{\rho}$	m ² /s		stokes, 1 St = 10 ⁻⁴ m ² /s

Unit conversions

Unit	MKSA (International System)	AGMA (US system)
Length	1 m = 3,280 8 ft 1 mm = 0,0393 7 in	1 ft = 0.304 8 m 1 in = 25.4 mm
Weight	1 kg = 2.204 6 lb	1 lb = 0.453 6 kg
Torque	1 Nm = 0.737 6 lb.ft 1 N.m = 141.6 oz.in	1 lb.ft = 1.356 N.m 1 oz.in = 0.007 06 N.m
Force	1 N = 0.224 8 lb	1 lb = 4.448 N
Moment of inertia	1 kg.m ² = 23.73 lb.ft ²	1 lb.ft ² = 0.042 14 kg.m ²
Power	1 kW = 1.341 HP	1 HP = 0.746 kW
Pressure	1 kPa = 0.145 05 psi	1 psi = 6.894 kPa
Magnetic flux	1 T = 1 Wb / m ² = 6.452 10 ⁴ line / in ²	1 line / in ² = 1.550 10 ⁻⁵ Wb / m ²
Magnetic losses	1 W / kg = 0.453 6 W / lb	1 W / lb = 2.204 W / kg

Multiples and sub-multiples		
Factor by which the unit is multiplied	Prefix to be placed before the unit name	Symbol to be placed before that of the unit
10 ¹⁸ or 1 000 000 000 000 000 000	exa	E
10 ¹⁵ or 1 000 000 000 000 000	peta	P
10 ¹² or 1 000 000 000 000	tera	T
10 ⁹ or 1 000 000 000	giga	G
10 ⁶ or 1 000 000	mega	M
10 ³ or 1 000	kilo	k
10 ² or 100	hecto	h
10 ¹ or 10	deca	da
10 ⁻¹ or 0.1	deci	d
10 ⁻² or 0.01	centi	c
10 ⁻³ or 0.001	milli	m
10 ⁻⁶ or 0.000 001	micro	μ
10 ⁻⁹ or 0.000 000,001	nano	n
10 ⁻¹² or 0.000 000,000,001	pico	p
10 ⁻¹⁵ or 0.000 000,000,000,001	femto	f
10 ⁻¹⁸ or 0.000 000,000,000,000,001	atto	a

Electro_Motor.ir

Standard formulae used in electrical engineering

MECHANICAL FORMULAE

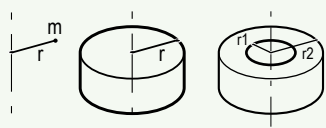
Title	Formula	Unit	Definitions / Notes
Force	$F = m \cdot \gamma$	F in N m in kg γ in m/s^2	A force F is the product of a mass m by an acceleration γ
Weight	$G = m \cdot g$	G in N m in kg $g = 9.81 m/s^2$	
Torque	$M = F \cdot r$	M in N.m F in N r in m	The torque M of a force in relation to an axis is the product of that force multiplied by the distance r of the point of application of F in relation to the axis.
Power	- rotating $P = M \cdot \omega$	P in W M in N.m ω in rad/s	Power P is the quantity of work yielded per unit of time $\omega = 2\pi N/60$ where N is the speed of rotation in min^{-1}
	- linear $P = F \cdot V$	P in W F in N V in m/s	V = linear velocity
Acceleration time	$t = J \cdot \frac{\omega}{M_a}$	t in s J in $kg \cdot m^2$ ω in rad/s M_a in Nm	J is the moment of inertia of the system M_a is the moment of acceleration Note: All the calculations refer to a single rotational speed ω , where the inertias at speed ω' are corrected to speed ω by the following calculation: $J_\omega = J_{\omega'} \cdot \left(\frac{\omega'}{\omega}\right)^2$
Moment of inertia Centre of gravity	$J = m \cdot r^2$		
Solid cylinder around its axis	$J = m \cdot \frac{r^2}{2}$	J in $kg \cdot m^2$ m in kg r in m	
Hollow cylinder around its axis	$J = m \cdot \frac{r_1^2 + r_2^2}{2}$		
Inertia of a mass in linear motion	$J = m \cdot \left(\frac{v}{\omega}\right)^2$	J in $kg \cdot m^2$ m in kg v in m/s ω in rad/s	

Standard formulae used in electrical engineering

ELECTRICAL FORMULAE

Title	Formula	Unit	Definitions / Notes
Accelerating torque	$M_a = \frac{M_d + 2M_a + 2M_m + M_n - M_r}{6}$ <p>General formula:</p> $M_a = \frac{1}{N_n} \int_0^{N_n} (M_{mot} - M_r) dN$	Nm	Moment of acceleration M_a is the difference between the motor torque M_{mot} (estimated), and the resistive torque M_r . (M_d , M_a , M_m , M_n , see curve below) N = instantaneous speed N_n = rated speed
Power required by the machine	$P = \frac{M \cdot \omega}{\eta_a}$	P in W M in N.m ω in rad/s η_a without unit	η_a expresses the efficiency of the driven machine. M is the torque required by the driven machine.
Power drawn by the 3-phase motor	$P = \sqrt{3} \cdot U \cdot I \cdot \cos \varphi$	P in W U in V I in A	φ phase angle by which the current lags or leads the voltage. U armature voltage. I line current.
Reactive power drawn by the motor	$Q = \sqrt{3} \cdot U \cdot I \cdot \sin \varphi$	Q in VAR	
Reactive power supplied by a bank of capacitors	$Q = \sqrt{3} \cdot U^2 \cdot C \cdot \omega$	U in V C in μ F ω in rad/s	U = voltage at the capacitor terminals C = capacitor capacitance ω = rotational frequency of supply phases ($\omega = 2\pi f$)
Apparent power	$S = \sqrt{3} \cdot U \cdot I$ $S = \sqrt{P^2 + Q^2}$	S in VA	
Power supplied by the 3-phase motor	$P = \sqrt{3} \cdot U \cdot I \cdot \cos \varphi \cdot \eta$		η expresses motor efficiency at the point of operation under consideration.
Slip	$g = \frac{N_s - N}{N_s}$		Slip is the difference between the actual motor speed N and the synchronous speed N_s
Synchronous speed	$N_s = \frac{120 \cdot f}{p}$	N_s in min^{-1} f in Hz	p = number of poles f = frequency of the power supply

Parameters	Symbol	Unit	Torque and current curve as a function of speed
Starting current	I_d	A	
Rated current	I_n		
No-load current	I_o		
Starting torque*	M_d	Nm	
Run up torque	M_a		
Breakdown torque	M_m		
Rated torque	M_n		
Rated speed	N_n	min^{-1}	
Synchronous speed	N_s		

* Torque is the usual term for expressing the moment of a force.

Tolerance on main performance parameters

TOLERANCES OF ELECTROMECHANICAL CHARACTERISTICS

IEC 60034-1 specifies standard tolerances for electromechanical characteristics.

Parameters	Tolerances
Efficiency { machines P ≤ 150 kW machines P > 150 kW	- 15 % of (1 - η) - 10 % of (1 - η)
Cos φ	- 1/6 (1 - cos φ) (min 0.02 - max 0.07)
Slip { machines P < 1 kW machines P ≥ 1 kW	±30 % ±20 %
Locked rotor torque	- 15 %, + 25 % of rated torque
Starting current	+ 20 %
Run-up torque	- 15 % of rated torque
Maximum torque	- 10 % of rated torque > 1.5 M _N
Moment of inertia	±10 %
Noise	+ 3 dB (A)
Vibration	+ 10 % of the guaranteed class

Note: IEC 60034-1 - does not specify tolerances for current
- the tolerance is ± 10% in NEMA-MG1

TOLERANCES AND ADJUSTMENTS

The standard tolerances shown below are applicable to the drawing dimensions given in our catalogues. They comply fully with the requirements of IEC standard 60072-1.

Characteristics	Tolerances
frame size H ≤ 250 ≥ 280	0, - 0.5 mm 0, - 1 mm
Diameter Ø of the shaft extension: - 11 to 28 mm - 32 to 48 mm - 55 mm and over	j6 k6 m6
Diameter N of flange spigots	j6 up to FF 500, js6 for FF 600 and more
Key width	h9
Width of drive shaft keyway (normal keying)	N9
Key depth: - square section - rectangular section	h9 h11
① Eccentricity of shaft in flanged motors (standard class) - diameter > 10 up to 18 mm - diameter > 18 up to 30 mm - diameter > 30 up to 50 mm - diameter > 50 up to 80 mm - diameter > 80 up to 120 mm	0.035 mm 0.040 mm 0.050 mm 0.060 mm 0.070 mm
② Concentricity of spigot diameter and ③ perpendicularity of mating surface of flange in relation to shaft (standard class) Flange (FF) or Faceplate (FT): - F 55 to F 115 - F 130 to F 265 - F 300 to F 500 - F 600 to F 740 - F 940 to F 1080	0.08 mm 0.10 mm 0.125 mm 0.16 mm 0.20 mm

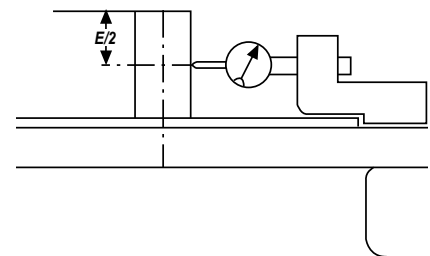

① Eccentricity of shaft in flanged motors

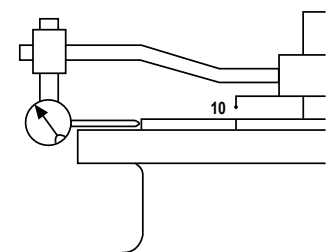

② Concentricity of spigot diameter

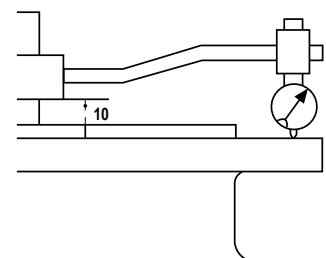

③ Perpendicularity of mating surface of flange in relation to shaft

Electro_Motor.ir

Declaration of EC conformance

 QUALITY MANAGEMENT	PS4 : INSPECTION, MEASURING & TEST EQUIPMENT MANAGEMENT	Classement/File: S4T007		
	EU DECLARATION OF CONFORMITY AND INCORPORATION		Révision: H Date: 26/ 07/ 2019	Page : 2 / 3
Doc type : S6T002 Rev D du/ from 16/03/2017		M <input type="checkbox"/> R <input checked="" type="checkbox"/> I <input type="checkbox"/> GP, Mansle & IMI	Annule et remplace/ Cancels and replaces: S4T007 Révision G du/ from 06/ 12/ 2018	

We, **MOTEURS LEROY SOMER**, boulevard Marcellin Leroy CS10015, 16915 ANGOULEME cedex 9, France, and we, **Constructions Electriques de Beaucourt (CEB)** 14, Rue de Dampierre, 90500 BEAUCOURT, France (company of Nidec Leroy-Somer Holding SA , boulevard Marcellin Leroy, CS 10015, 16915 ANGOULEME cedex 9, France).

declare, under our own responsibility that the following products:

(F)LS, PLS, (F)LSSES, PLSES et LSMV induction motor range

comply with:

- European Directives :
 - Low Voltage Directive **2014/35/EU**
 - ROHS 2 Directive **2011/65/EU**
 - Electromagnetic Compatibility Directive **2014/30/EU**
 - ErP Directive **2009/125/EC** and regulation (EC) application : **640/2009** and corrections (only for concerned products)

- European standards :
 - EN 50581:2012**
 - EN 60034-1:2010; 60034-7:1993/A1:2001; 60034-9:2005/A1:2007; 60034-14:2018; 62262 :2002**

This conformity permits the use of these ranges of products in machines subject to the application of the Machinery Directive 2006/42/EC, provided that they are integrated or incorporated and/or assembled in accordance with, amongst others, the regulations of standard EN 60204(all parts) "Electrical Equipment for Machinery".

The products defined above may not be put into service until the machines in which they are incorporated have been declared as complying with the applicable Directive.

Installation of these materials shall be done by a professional who is responsible to comply with the regulations, decrees, laws, orders, directives, application circulars, standards, rules or any other document relating to the installation site. He will be also responsible for the respect of values stamped on motor rating plate(s), instruction manual, installation instructions, maintenance manuals and/or any other document supplied by the manufacturer. MOTEURS LEROY-SOMER and CEB accepts no liability in the event of failure to comply with these rules and regulations.

Date and Signature of technical director:

Eric VASSENT

2019/07/29

Electro_Motor.ir

LEROY-SOMER[™]

www.leroy-somer.com

Connect with us at:

twitter.com/Leroy_Somer_en

facebook.com/leroy-somer.nidec.en

youtube.com/user/LeroySomerOfficial

linkedin.com/company/leroy-somer



Nidec
All for dreams

Electro-Motor.ir

© 2019 Moteurs Leroy-Somer SAS. The information contained in this brochure is for guidance only and does not form part of any contract. The accuracy cannot be guaranteed as Moteurs Leroy-Somer SAS have an ongoing process of development and reserve the right to change the specification of their products without notice.

Moteurs Leroy-Somer SAS. Headquarters: Bd Marcellin Leroy, CS 10015, 16915 Angoulême Cedex 9, France. Share Capital: 65 800 512 €, RCS Angoulême 338 567 258.