

**B 1091 – en**

**Motors**

Operating and Assembly Instructions

[Electro~Motor.ir](http://Electro~Motor.ir)





## Safety and operating instructions for electric motors

(according to: Low Voltage Directive 2014/35/EU)

### 1 General

During operation, devices may, depending on their protection class, have live, bare, moving or rotating parts or hot surfaces.

Unauthorised removal of covers, improper use, incorrect installation or operation causes a risk of serious personal injury or material damage.

Further information can be found in this documentation.

All transportation, installation commissioning and maintenance work must be carried out by qualified personnel (compliant with IEC 364 or CENELEC HD 384 or DIN VDE 0100 and IEC 664 or DIN VDE 0110 and national accident prevention regulations).

For the purposes of these basic safety instructions, qualified personnel are persons who are familiar with the assembly, installation, commissioning and operation of this product and who have the relevant qualifications for their work.

### 2. Proper use in Europe

The devices are components intended for installation in electrical systems or machines.

When installed in machines, the devices must not be commissioned (i.e. commencement of the proper use) until it has been ensured that the machine meets the provisions of the EC Directive 2006/42/EEC (Machinery Directive); EN 60204 must also be complied with.

Commissioning (i.e. implementation of proper use) is only permitted if the EMC directive (2014/30/EU) is complied with.

Devices with a CE label meet the requirements of the Low Voltage Directive 2014/35/EU. The stated harmonized standards for the devices are used in the declaration of conformity.

Technical data and information for connection conditions can be found on the rating plate and in the documentation, and must be complied with.

The devices may only be used for safety functions which are described and explicitly approved.

### 3. Transport, storage

Information regarding transport, storage and correct handling must be complied with.

### 4. Installation

The installation and cooling of the equipment must be implemented according to the regulations in the corresponding documentation.

The devices must be protected against impermissible loads. Especially during transport and handling, components must not be deformed and/or insulation distances must not be changed.

Electrical components must not be mechanically damaged or destroyed (this may cause a health hazard!).

### 5. Electrical Connection

When working on live devices, the applicable national accident prevention regulations must be complied with.

The electrical installation must be implemented according to the applicable regulations (e.g. cable cross-section, fuses, earth lead connections). Further instructions can be found in the documentation.

Information regarding EMC-compliant installation – such as shielding, earthing, location of filters and installation of cables – can be found in the documentation for the devices. These instructions must be complied with even with CE marked devices. Compliance with the limiting values specified in the EMC legal regulations is the responsibility of the manufacturer of the system or machine.

### 6. Operation

Where necessary, systems in which the devices are installed must be equipped with additional monitoring and protective equipment according to the applicable safety requirements, e.g. legislation concerning technical equipment, accident prevention regulations, etc.

The parameterisation and configuration of the devices must be selected so that no hazards can occur.

All covers must be kept closed during operation.

### 7. Maintenance and repairs

The following applies in particular for operation with frequency inverters:

After the devices are disconnected from the power supply, live equipment components and power connections should not be touched immediately, because of possible charged capacitors. Observe the applicable information signs located on the device.

Further information can be found in this documentation.

**These safety instructions must be kept in a safe place!**

Electro~Motor.ir

## Documentation

**Title:** B 1091  
**Order no.:** 6051302  
**Series:**

**Asynchronous motors / synchronous motors**  
**• Single and three-phase asynchronous motors**  
**SK 63<sup>\*1/\*2</sup> \*3) to SK 315<sup>\*1/\*2</sup> \*3)**

- 1) Power labelling: S, SA, SX, M, MA, MB, MX, L, LA, LB, LX, R, X, Y, A, W  
 - optionally supplemented with: H, P
- 2) Pole number labelling: 2, 4, 6, 8, ...
- 3) Further options

**• Three-phase asynchronous motors**  
**SK 63<sup>\*1/\*2</sup> 2D \*3) to SK 250<sup>\*1/\*2</sup> 2D \*3)**

- 1) Power labelling: S, SA, SX, M, MA, MB, MX, L, LA, LB, LX, R, X, Y, A, W  
 - optionally supplemented with: H, P
- 2) Pole number labelling: 4, 6
- 3) Options

with ATEX labelling  II 2D Ex tb IIIC T . . . °C Db

**SK 63<sup>\*1/\*2</sup> 3D \*3) to SK 250<sup>\*1/\*2</sup> 3D \*3)**

- 1) Power labelling: S, SA, SX, M, MA, MB, MX, L, LA, LB, LX, R, X, Y, A, W  
 - optionally supplemented with: H, P
- 2) Pole number labelling: 4, 6
- 3) Options

with ATEX labelling  II 3D Ex tc IIIB T . . . °C Dc

**SK 63<sup>\*1/\*2</sup> 2G \*3) to SK 200<sup>\*1/\*2</sup> 2G \*3)**

- 1) Power labelling: S, SA, SX, M, MA, MB, MX, L, LA, LB, LX, R, X, Y, A, W  
 - optionally supplemented with: H, P
- 2) Pole number labelling: 4, 6
- 3) Further options

with ATEX labelling  II 2G Ex eb IIC T3 Gb

**SK 63<sup>\*1/\*2</sup> 3G \*3) to SK 200<sup>\*1/\*2</sup> 3G \*3)**

- 1) Power labelling: S, SA, SX, M, MA, MB, MX, L, LA, LB, LX, R, X, Y, A, W  
 - optionally supplemented with: H, P
- 2) Pole number labelling: 4, 6
- 3) Further options

with ATEX labelling  II 3G Ex ec IIC T3 Gc

Electro~Motor.ir

## Version list

Title, Date	Order number / Version	Remarks
	Internal code	
<b>B 1091</b> , January 2015	<b>6051302 / 0215</b>	-
<b>B 1091</b> , March 2016	<b>6051302 / 1016</b>	<ul style="list-style-type: none"> <li>• General corrections</li> <li>• Structural modifications to the document</li> </ul>
<b>B 1091</b> , December 2016	<b>6051302 / 4816</b>	<ul style="list-style-type: none"> <li>• General corrections</li> </ul>
<b>B 1091</b> , June 2017	<b>6051302 / 2417</b>	<ul style="list-style-type: none"> <li>• Technical supplements</li> </ul>
<b>B 1091</b> , August 2017	<b>6051302 / 3517</b>	<ul style="list-style-type: none"> <li>• Technical supplements</li> </ul>
<b>B 1091</b> , June 2018	<b>6051302 / 2318</b>	<ul style="list-style-type: none"> <li>• General corrections</li> <li>• Update of EU Declaration of Conformity 2D / 3D</li> </ul>
<b>B 1091</b> , August 2018	<b>6051302 / 3118</b>	<ul style="list-style-type: none"> <li>• General corrections</li> <li>• Section for operation with frequency inverter removed</li> <li>• Section for special operating conditions, permissible surrounding area supplemented</li> <li>• Ignition protection type labelling and name plates updated</li> <li>• Update of EU Declaration of Conformity 2G / 3G</li> </ul>
<b>B 1091</b> , June 2019	<b>6051302 / 2319</b>	<ul style="list-style-type: none"> <li>• General corrections</li> <li>• Update of EU Declaration of Conformity 3D</li> </ul>
<b>B 1091</b> , October 2020	<b>6051302 / 4020</b>	<ul style="list-style-type: none"> <li>• General corrections</li> <li>• Supplement to new section for use of explosion-protected electric motors in the People's Republic of China</li> </ul>
<b>B 1091</b> , March 2021	<b>6051302 / 1221</b>	<ul style="list-style-type: none"> <li>• General corrections</li> </ul>
<b>B 1091</b> , July 2021	<b>6051302 / 2721</b>	<ul style="list-style-type: none"> <li>• Supplement to section               <ul style="list-style-type: none"> <li>– Explosion-protected electric motors according to Class I Div.2</li> <li>– Explosion-protected electric motors according to Class II Div.2</li> </ul> </li> </ul>
<b>B 1091</b> , July 2022	<b>6051302 / 2722</b>	<ul style="list-style-type: none"> <li>• General corrections</li> <li>• Update of standard specifications</li> <li>• Removal of the chapter for synchronous motors (see new manual B5000)</li> <li>• Incremental encoder added</li> </ul>
	34158	

## Copyright notice

As an integral component of the device described here, this document must be provided to all users in a suitable form.

Any editing or amendment or other utilisation of the document is prohibited.

## Publisher

### **Getriebebau NORD GmbH & Co. KG**

Getriebebau-Nord-Straße 1 • 22941 Bargteheide, Germany • <http://www.nord.com>

Fon +49 (0) 45 32 / 289-0 • Fax +49 (0) 45 32 / 289-2253

**Member of the NORD DRIVESYSTEMS Group**

Electro~Motor.ir

Electro~Motor.ir

## Table of Contents

<b>1</b>	<b>General</b> .....	<b>9</b>
1.1	Safety and installation notes .....	10
1.1.1	Explanation of labels used.....	10
1.1.2	List of safety and installation notes.....	11
1.2	Field of use .....	12
1.3	Correct handling of electric motors.....	13
1.3.1	Transport, storage .....	13
1.3.2	Installation .....	13
1.3.3	Balancing, drive elements .....	14
1.3.4	Alignment .....	15
1.3.5	Output shafts .....	15
1.3.6	Maximum thermal expansion at rated values .....	15
1.3.7	Electrical connection.....	16
1.3.8	Operation with frequency inverters .....	17
1.3.9	Checking the insulation resistance .....	20
1.3.10	Commissioning.....	20
1.3.11	Disposal.....	21
<b>2</b>	<b>Maintenance and servicing</b> .....	<b>22</b>
2.1	Safety measures .....	22
2.2	Bearing replacement periods .....	23
2.3	Maintenance intervals .....	24
2.4	General overhaul.....	24
<b>3</b>	<b>ATEX Explosion hazard areas</b> .....	<b>25</b>
3.1	Motors with increased ignition protection, type Ex eb .....	25
3.1.1	Cable glands.....	26
3.1.2	Cable connections .....	26
3.1.3	Terminal box cover seals.....	27
3.1.4	Motor position – special features IM V3, IM V6 .....	27
3.1.5	Further operating conditions.....	28
3.1.6	Protective devices .....	28
3.1.7	Operation with frequency inverter.....	29
3.1.8	Repairs .....	30
3.1.9	Painting .....	30
3.1.10	Name plate of NORD Ex eb motors according to EN IEC 60079-0:2018 .....	31
3.1.11	Applied standard versions .....	31
3.2	Motors with ignition protection class Non Sparking Ex ec.....	32
3.2.1	Cable glands.....	33
3.2.2	Cable connections .....	33
3.2.3	Terminal box cover seals.....	34
3.2.4	Motor position – special features IM V3, IM V6 .....	34
3.2.5	Further operating conditions .....	35
3.2.6	Protective devices .....	35
3.2.7	Repairs .....	35
3.2.8	Painting .....	36
3.2.9	Type plate for NORD Ex ec motors according to EN IEC 60079-0:2018.....	37
3.2.10	Applied standard versions .....	37
3.3	Motors for use in Zone 21 and Zone 22 according to EN 60079 and IEC 60079.....	38
3.3.1	Commissioning information / Application area.....	39
3.3.2	Terminal box cover seals.....	40
3.3.3	Electrical Connection.....	40
3.3.4	Cable glands.....	41
3.3.5	Permissible ambient temperature range.....	42
3.3.6	Painting .....	42
3.3.7	IEC-B14 motors.....	42
3.3.8	Motor position – special features IM V3, IM V6 .....	42
3.3.9	Further operating conditions.....	43
3.3.10	Design and operating principle.....	43
3.3.11	Minimum cross section of bonding conductors.....	43
3.3.12	Maintenance.....	44

3.4	Options for motors for use in Zone 21 and Zone 22.....	45
3.4.1	Operation with frequency inverters .....	45
3.4.2	External fan .....	46
3.4.3	Second temperature sensor 2TF .....	47
3.4.4	Back stop.....	47
3.4.5	Brake .....	47
3.4.6	Incremental encoder.....	48
3.4.7	Overview of brake attachment for NORD ATEX motors .....	48
3.4.8	Name plate of motors (Ex tb, Ex tc) according to EN 60079 for FI operation .....	49
3.5	Motors according to TP TC012/2011 for the Eurasian Economic Union .....	50
3.5.1	Type plates / Labelling.....	50
3.5.2	Standards .....	51
3.5.3	Service life.....	51
3.5.4	Special operating conditions (X-labelling).....	51
3.6	Motors according to GB 12476.1-2013 / GB 12476.5-2013 for the People's Republic of China .....	52
3.6.1	Type plates / Labelling.....	52
3.6.2	Standards to be observed during operation and maintenance .....	53
3.7	Explosion-protected electric motors according to Class I Div.2.....	54
3.7.1	Cable connections .....	55
3.7.2	Terminal box cover seals.....	55
3.7.3	Electrical Connection.....	56
3.7.4	Motor position – special features IM V3, IM V6 .....	56
3.7.5	Further operating conditions .....	57
3.8	Explosion-protected electric motors according to Class II Div.2.....	58
3.8.1	Terminal box cover seals.....	59
3.8.2	Electrical Connection.....	60
3.8.3	Motor position – special features IM V3, IM V6 .....	60
3.8.4	Cables and cable glands .....	61
3.8.5	Painting .....	61
3.8.6	IEC-B14 motors .....	61
3.8.7	Further operating conditions .....	61
3.8.8	Minimum cross section of bonding conductors.....	62
3.8.9	Operation with frequency inverters .....	63
3.8.10	Maintenance .....	64
<b>4</b>	<b>Replacement parts .....</b>	<b>65</b>
<b>5</b>	<b>Declarations of Conformity .....</b>	<b>66</b>



## **1 General**

These operating instructions must be read before NORD motors are transported, installed, commissioned, serviced or repaired. All persons who are involved in these tasks must observe these operating instructions. In order to prevent injury or damage, all of the safety information in these operating instructions must be strictly observed.

The information and instructions in the instructions, safety and commissioning information which is supplied, as well as all other instructions must be observed.

This is essential to prevent injury and damage.

The applicable national, local and plant-specific regulations and requirements and regulations must be observed.

**Technical details may vary for special designs and constructions. In case of doubt, we urgently recommend that the manufacturer is contacted, giving details of the type designation and the motor number.**

Qualified personnel are persons who due to their training, experience and instruction, and their knowledge of the relevant standards, accident prevention regulations and operating conditions are authorised to carry out the necessary activities.

This also includes knowledge of first aid measures and the local emergency services.

It is assumed that the work for transport, assembly, installation, commissioning, maintenance and repair will be performed by qualified staff.

In particular, the following must be observed:

- Technical data and information regarding permissible use, installation, connection, ambient and operating conditions, which are contained in the catalogue, the order documents and other documentation for the product.
- Local and plant-specific regulations and requirements
- Correct use of tools, lifting and transportation equipment
- Use of personal protective equipment

For reasons of clarity, the operating instructions do not contain detailed information about possible versions and therefore do not consider all possible cases of installation, operation or servicing.

Because of this, these operating instruction essentially only contain the information which is necessary for proper use by qualified personnel.

In order to prevent faults it is necessary that the prescribed service and inspection work is carried out by appropriately qualified personnel.

- For the operation on an inverter, the planning guideline B1091-1 forms a part of these operating instructions.
- The supplementary operating instructions must be observed if an external fan is present.
- For braking motors, the supplementary brake operating instructions must be observed..

If the operating instructions or the planning guide are lost for any reason, these documents must be obtained from NORD.

## 1.1 Safety and installation notes

The devices are operating materials intended for use in industrial high voltage systems, and are operated at voltages that could lead to severe injuries or death if they are touched.





The device and its accessories must only be used for the purpose which is intended by the manufacturer. Unauthorised modifications and the use of spare parts and additional equipment which has not been purchased from or recommended by the manufacturer of the device may cause fire, electric shock and injury.

All of the associated covers and protective devices must be used.

Installation and other work may only be carried out by qualified electricians with strict adherence to the operating instructions. Therefore keep these Operating Instructions at hand, together with all supplementary instructions for any options which are used, and give them to each user.

Local regulations for the installation of electrical equipment and accident prevention must be complied with.

### 1.1.1 Explanation of labels used

 <b>DANGER</b>	Indicates an immediate danger, which may result in death or serious injury.
 <b>WARNING</b>	Indicates a possibly dangerous situation, which may result in death or serious injury.
 <b>CAUTION</b>	Indicates a possibly dangerous situation, which may result in slight or minor injuries.
<b>NOTICE</b>	Indicates a possibly harmful situation, which may cause damage to the product or the environment.
 <b>Note</b>	Indicates hints for use and useful information.

### 1.1.2 List of safety and installation notes



#### **DANGER!**

#### **Electric shock**

The motor is operated with a dangerous voltage. Touching certain conducting components (connection terminals and supply cables) will cause electric shock with possibly fatal consequences.

Even when the motor is at a standstill (e.g. due to the electronic block of a connected frequency inverter or a jammed drive unit) the connection terminals and supply cables may carry a dangerous voltage. A motor standstill is not identical to electrical isolation from the mains.

Even if the drive unit has been disconnected from the mains, a connected motor may rotate and possibly generate a dangerous voltage.

Installation and work must only be carried out when the motor is at a standstill and is **disconnected** (all phases disconnected from the mains).

Follow the **5 Safety Rules** (1. Switch off the power, 2. Secure against switching on, 3. Check for no voltage, 4. Earthing and short circuiting, 5. Cover or fence off neighbouring live components).



#### **WARNING**

#### **Hazard due to heavy loads**

The large weight of the motor must be taken into account during any transportation or installation work.

Incorrect handling may cause the motor to fall or swing without control and therefore cause severe, and possibly fatal injuries due to impact, crushing and other physical injuries. In addition, severe damage to the motor and its surroundings are possible.

Therefore:

- Do not stand under suspended loads
- Only use the attachment points provided
- Check that lifting equipment and lashings have an adequate load capacity and are undamaged
- Avoid hectic movements
- Use personal protective equipment



#### **WARNING**

#### **Injury due to movement**

Under certain conditions (e.g. switching on the power supply, releasing a holding brake) the motor may start to move. The machinery which it drives (press / chain hoist / roller / fan etc.) may then make an unexpected movement. This may cause various injuries, including to third parties.

Before switching on, secure the danger area by warning and removing all persons from the danger area.



#### **WARNING**

#### **Hazard due to loose parts**

Care must be taken that there are no loose parts on the motor. Otherwise, these may cause injury during transportation and installation work, or when the motor is in operation.

Loose carrying or lifting eyes may cause the motor to fall during transportation.

Parallel keys on the motor shaft may be thrown out when the motor shaft rotates.

Fasten or remove loose parts and carrying or lifting eyes; secure or remove free parallel shaft keys on the motor shaft(s).



#### **CAUTION**

#### **Danger of burns**

The surface of the motor may heat up to temperatures in excess of 70°C.

Touching the motor may cause local burns to the affected parts of the body (hands, fingers, etc.).

To prevent such injuries, allow sufficient time for cooling down before starting work - the surface temperature should be checked with suitable measuring equipment. In addition, keep sufficient distance from adjacent components during installation, or install protection against contact.

Electro~Motor.ir

## 1.2 Field of use

### *Use of the motors:*

The motors may only be used for their intended purpose (to drive machinery).

The motors are constructed with at least protection class IP55 (for the protection class: see rating plate). They may be installed in dusty or damp environments.

In principle the conditions of use and the ambient conditions determine the necessary protection class and any other additional measures. For outdoor installation and vertical versions, e.g. V1 or V5 with the shaft pointing downwards, Getriebebau NORD recommends the use of the double fan cover option [RDD].

Motors must be protected against intensive sunlight, e.g. by the use of a protective cover. The insulation is tropicalised.

Installation altitude:  $\leq 1000$  m

Ambient temperature:  $-20^{\circ}\text{C} \dots +40^{\circ}\text{C}$

For standard motors an extended ambient temperature range from  $-20^{\circ}\text{C} \dots +60^{\circ}\text{C}$  is permissible. In this case, the rated power must be reduced to **82%** of the value stated in the catalogue. If the maximum ambient temperature is between  $+40^{\circ}\text{C}$  and  $+60^{\circ}\text{C}$ , the power output should be inversely linearly interpolated between **100%** and **82%**.

The motor connection cables and the cable glands must be suitable for temperatures  $\geq 90^{\circ}\text{C}$ .

### 1.3 Correct handling of electric motors

All work must only be carried out with the power to the system switched off.

#### 1.3.1 Transport, storage



#### WARNING

#### Fall hazard

Incorrect handling during transport may result in the motor falling down or swivelling uncontrolledly, and thus possibly causing serious or fatal injuries such as bruises, contusions and other physical injuries. It may also result in serious damage to the motor and its environment.

That is why:

- Use the existing threads for ring bolts during transport (see following illustration).
- Do not attach additional loads! The lifting eyes are designed for the motor weight only.
- For transporting the machine units (e.g. gear unit attachments), only use the lifting eyes and pins provided for this purpose!
- Machine units must not be lifted by attaching them to the individual machines!

To avoid any damage to the motor, the motor must always be lifted via suitable lifting equipment. If the period between delivery and motor commissioning is more than four years under favourable conditions (storage in dry and dust-free spaces protected from vibrations), the roller bearings should be replaced. Unfavourable conditions significantly reduce the period. If necessary, unprotected and finished surfaces (flange surface, shaft end, ...) may be treated with corrosion protection agents. If necessary, the winding's insulation resistance must be checked (📖 1.3.9 "Checking the insulation resistance").

Changes compared to normal operation (increased power consumption, higher temperatures or vibrations, unusual noises or odours, response of monitoring systems, etc.) may indicate that the function is impaired. To avoid personal injury or material damage, the maintenance staff responsible must be informed of these changes without delay.

In case of doubt, switch off the motor immediately as soon as this is allowed by the system's state.

#### Mounting of ring bolts for transport

The number, position and thread size of the ring bolts provided for transport varies depending on the motor size.

Size	Threads	Position
63	...	...
71	...	...
80	M6	2, 4
90	M8	1, 2, 3, 4
100	M8	1, 2, 3, 4
100 APAB	M8	2, 4
112	M8	1, 2, 3, 4
132	M10	1, 2, 3, 4
160	M12	1, 2, 3, 4
180	M12	1, 2, 3, 4
200X	M12	1, 2, 3, 4

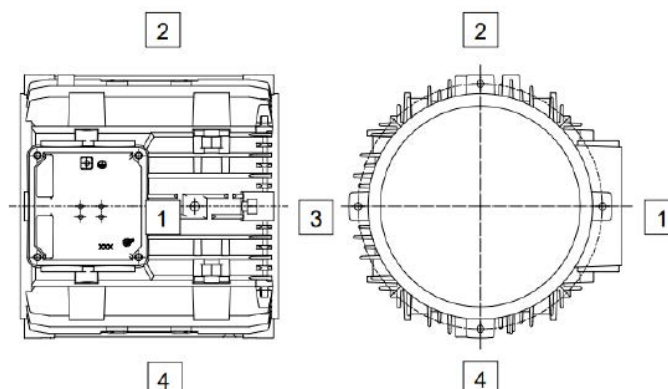

#### 1.3.2 Installation

- After installation, screwed-on lifting lugs must be tightened or removed.

- Smooth running: Precise alignment of the clutch and a well-balanced drive element (clutch, pulleys, fan, etc.) are prerequisites for smooth vibration-free running.
- Complete balancing of the motor and the drive elements may be necessary.
- The top section of the terminal box and the position of the terminal box can be rotated by 4 x 90 degrees.
- Even if not required, on IEC B14 motors **all four** fixing screws, must be screwed into the flanged bearing plate! The fixing screw threads must be inserted with a sealant, e.g. Loctite 242.

**WARNING****Electric shock**

The **maximum** depth for screwing into the type plate is **2 x d**. There is a danger that the motor windings may be damaged if longer screws are used. This creates a danger of potential transfer to the housing and danger of electric shock if touched.

- The motor must be inspected for damage before installation and commissioning. A damaged motor must not be commissioned.
- Rotating shaft ends and unused shaft ends must be protected against contact. Unused parallel shaft keys must be secured against being thrown out.
- The motor must be suitable for the installation location. (requirements prescribed by standards, ambient conditions, installation altitude)
- Motor surfaces may become very hot during operation. Suitable protective measures must be taken if there is a danger of contact or a hazard to the vicinity of the installation.

### 1.3.3 Balancing, drive elements

The fitting and removal of drive elements (clutch, pulley, gear wheel,...) must be performed with suitable equipment. As standard the rotors are balanced with half key balancing. **The appropriate form of balancing must be observed if drive elements are installed on the motor shaft. Drive elements must be balanced according to ISO 1940.**

The generally required measures for protection against touching the drive elements must be observed. If a motor is started without a drive element, the parallel key must be secured against being thrown out. This also applies for any second shaft end. Alternatively, the parallel shaft key must be removed.

### 1.3.4 Alignment

In particular with direct coupling, the motor shafts and the driven machine must be axially and radially aligned to each other. Incorrect alignment may result in damage to the bearings, excessive vibration and breakage of the shaft.

### 1.3.5 Output shafts

The maximum permissible axial ( $F_A$ ) and radial forces ( $F_R$ ) for the A side end of the motor shaft can be obtained from the table below. Getriebebau NORD should be consulted if the radial force ( $F_R$ ) is applied at a distance which is greater than the length  $E/2$ .

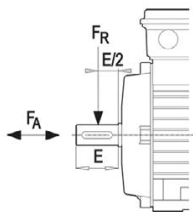

Type	$F_R$ [N]	$F_A$ [N]
63	530	480
71	530	480
80	860	760
90	910	810
100	1300	1100
112	1950	1640
132	2790	2360
160	3500	3000
180 .X	3500	3000
180	5500	4000
200 .X	5500	4000
225	8000	5000
250	8000	5000

**No** axial ( $F_A$ ) and radial forces ( $F_R$ ) are permissible for the B side shaft end.

NOTICE! Attachments must not cause rubbing (danger of excessive temperatures and sparking) or impair the necessary flow of cooling air.

### 1.3.6 Maximum thermal expansion at rated values

Size	Shaft [mm]	Housing length [mm]	Housing diameter [mm]
63	0.19	0.39	0.28
71	0.22	0.47	0.31
80	0.25	0.53	0.36
90	0.30	0.62	0.40
100	0.35	0.69	0.45
112	0.36	0.78	0.50
132	0.46	0.91	0.60
160	0.57	1.04	0.73
180 .X	0.62	1.04	0.73
180	0.67	1.26	0.82
200 .X	0.67	1.26	0.82
225	0.85	0.58	0.41
250	0.85	0.58	0.41

Electro~Motor.ir

### 1.3.7 Electrical connection

The connection cables must be inserted into the terminal box using cable glands. The terminal box must be sealed against dust and water. Mains voltage and mains frequency must match the data on the rating plate.  $\pm 5\%$  voltage or  $\pm 2\%$  frequency deviations are permissible without power reduction. The connection and configuration of the jumpers must be made according to the circuit diagram in the terminal box.

Please refer to the following table for the designations of the auxiliary terminals.

Auxiliary terminal designation		
Additional equipment	Labelling of auxiliary terminals EN 60034-8	Comment
<b>Thermistor</b>  Option: TF	TP1 – TP2 1TP1 – 1TP2 2TP1 – 2TP2 3TP1 – 3TP2 4TP1 – 4TP2 5TP1 – 5TP2	Switch-off Warning Winding 1 Switch-off Winding 1 Warning Winding 2 Switch-off Winding 2 Brake
<b>Bi-metal temperature sensor Normally closed</b> Option: TW	1TB1 – 1TB2 2TB1 – 2TB2 3TB1 – 3TB2 4TB1 – 4TB2	Warning Winding 1 Switch-off Winding 1 Warning Winding 2 Switch-off Winding 2
<b>Bi-metal temperature sensor, normally open</b>	1TM1 – 1TM2 2TM1 – 2TM2 3TM1 – 3TM2 4TM1 – 4TM2	Warning Winding 1 Switch-off Winding 1 Warning Winding 2 Switch-off Winding 2
<b>PT100 / PT1000</b>	1R1 – 1R2 2R1 – 2R2 3R1 – 3R2	Winding 1 (Phase U) Winding 1 (Phase V) Winding 1 (Phase W)
<b>KTY Silicon temperature sensor</b>	(+) 4R1 – 4R2 (-) (+) 5R1 – 5R2 (-)	Winding 1 Winding 2
<b>Anti-condensation heater</b> Option: SH	1HE1 – 1HE2 2HE1 – 2HE2	Motor heater Brake heater
<b>Capacitor</b> Motor option: EAR/EHB/EST	1CA1 – 1CA2 2CA1 – 2CA2 3CA1 – 3CA2 4CA1 – 4CA2	for operating capacitor 1 for operating capacitor 2 for starting capacitor 1 for starting capacitor 2
<b>Direct current brake</b> Option: BRE...	BD1 – BD2	
Option: DBR...	Brake1: BD1-BD2 Brake2: BD3-BD4	



### 1.3.8 Operation with frequency inverters

Three-phase asynchronous motors of type SK 63 / . – SK 250 / . have been qualified for operation with link circuit inverters according to DIN EN 60034-18-41 (2014).

Please also observe the operating instructions for the frequency inverter in use.

The insulation system used by NORD consists of suitable varnished copper wire, phase insulation, homogeneous impregnation and groove lining as insulation against earth and is designed for the increased requirements of the link circuit inverter in the standard version.

The maximum permissible FI input voltage is 500 V +10 %. Link circuit voltages in excess of 750 V DC are not permissible. Peak voltages due to the system of inverter, cable and motor must not exceed the following values when the motor is warm due to operation.

Permissible impulse voltages depending on the voltage rise time

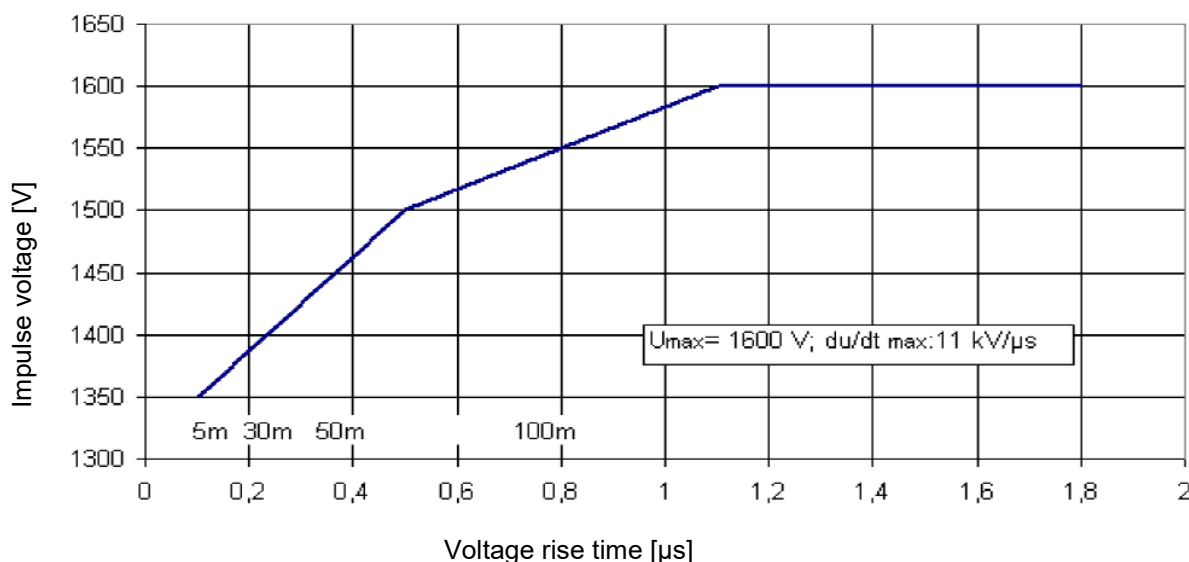

If the values are outside of the permissible range, du/dt or sine wave filters may be used (note additional voltage drop).

The cable lengths shown in the diagram are for guidance only and may deviate corresponding to the specific conditions.

In principle, attention must be paid to an EMC-compliant installation.

Additional information on operation on the frequency inverter, in particular information on the max. permissible speed, the thermal design and the possible torques, can be found in the current NORD motor catalogue M7000.

### Power losses according to (EU) 2019/1781

Please find the “power losses expressed in percentage (%) of the rated output power (speed vs. torque) according to (EU) 2019/1781” in the below overview.

Motor type	Frequency [Hz]	Relative losses (Speed/torque)						
		25/25 [%]	25/100 [%]	50/25 [%]	50/50 [%]	50/100 [%]	90/50 [%]	90/100 [%]

Notice: A comma counts as a full stop and signifies a decimal place.

63SP/4	50	20,1	41,3	21,8	26,1	42,9	30,0	47,0
63SP/4	60	16,6	32,6	17,8	23,3	34,7	27,7	40,6
63LP/4	50	18,3	38,1	19,6	23,5	38,5	26,9	41,2
63LP/4	60	18,6	31,4	20,0	23,0	33,0	27,0	36,8
71SP/4	50	9,6	24,7	12,1	15,1	27,3	20,4	33,2
71SP/4	60	9,2	19,6	12,1	14,5	23,2	21,4	30,4
71LP/4	50	9,4	27,8	12,0	15,5	29,3	20,6	34,2
71LP/4	60	9,0	20,9	11,9	14,5	24,5	21,0	31,5
80SP/4	50	5,4	19,4	6,6	9,1	20,0	11,3	21,8
80SP/4	60	5,0	14,3	6,2	8,1	15,4	11,0	18,6
80LP/4	50	4,0	17,2	4,9	7,2	17,3	9,2	19,0
80LP/4	60	3,7	12,3	4,7	6,4	13,2	8,9	15,9
90SP/4	50	2,5	9,9	4,5	6,2	14,0	8,1	16,0
90SP/4	60	3,2	10,1	4,3	5,7	11,1	8,3	13,8
90LP/4	50	3,2	16,7	4,0	6,1	15,8	7,6	16,9
90LP/4	60	2,9	11,4	3,8	5,3	11,8	7,3	13,9
100LP/4 APAB	50	2,6	10,4	3,5	4,7	10,8	6,9	13,3
100LP/4 APAB	60	2,4	7,9	3,7	4,4	9,3	7,1	11,7
100AP/4 APAB	50	2,0	11,4	2,9	4,4	11,7	6,0	13,5
100AP/4 APAB	60	1,8	7,9	2,6	3,5	8,6	5,8	10,9

Motor type	Frequency [Hz]	Relative losses (Speed/torque)						
		25/25 [%]	25/100 [%]	50/25 [%]	50/50 [%]	50/100 [%]	90/50 [%]	90/100 [%]

Notice: A comma counts as a full stop and signifies a decimal place.

112MP/4	50	2,1	11,2	2,8	4,1	11,3	5,7	12,4
112MP/4	60	1,9	7,8	2,9	3,8	8,7	5,6	10,7
132SP/4	50	1,7	7,3	2,7	3,5	8,1	5,3	10,1
132SP/4	60	1,8	5,5	2,7	3,4	6,6	6,1	9,2
132MP/4	50	1,8	8,3	2,4	3,5	8,8	5,0	10,6
132MP/4	60	1,7	6,0	2,5	3,2	6,8	5,7	8,9
160SP/4	50	1,2	6,1	1,6	2,5	6,5	3,9	8,3
160SP/4	60	1,1	4,5	1,9	2,5	5,2	4,4	7,8
160MP/4	50	1,1	6,4	1,6	2,6	6,7	3,7	8,0
160MP/4	60	0,9	4,6	1,5	2,4	5,0	3,8	6,3
160LP/4	50	1,1	5,9	1,6	2,4	6,6	3,4	8,5
160LP/4	60	1,0	4,1	1,7	2,2	4,9	3,5	6,5
180MP/4	50	1,1	4,3	1,4	2,0	4,8	2,9	6,2
180MP/4	60	0,9	3,3	1,4	1,9	4,4	2,8	5,7
180LP/4	50	0,8	4,8	1,1	1,7	4,9	2,5	5,4
180LP/4	60	0,7	3,5	1,1	1,6	4,1	2,1	4,7
225RP/4	50	0,7	3,7	1,2	1,6	4,1	2,8	5,3
225RP/4	60	0,7	2,8	1,2	1,7	3,8	3,6	5,2
225SP/4	50	0,7	3,8	1,0	1,6	4,2	2,4	4,8
225SP/4	60	0,6	2,9	0,9	1,4	3,4	1,8	5,0
225MP/4	50	0,6	3,7	0,8	1,3	3,9	2,0	4,6
225MP/4	60	0,6	2,8	0,8	1,3	3,0	2,3	3,6
250WP/4	50	0,5	4,2	0,7	1,3	4,5	1,5	5,3
250WP/4	60	0,5	3,0	0,7	1,2	3,4	1,9	4,3

### 1.3.9 Checking the insulation resistance

Prior to initial commissioning of the motor after a long period of storage or standstill (approx. 6 months) the insulation resistance of the windings must be checked. During and immediately after the measurements, the terminals have voltages which can be dangerous, and must not be touched.

#### Insulation resistance

The insulation resistance of new, cleaned, repaired windings against the housing and against each other is  $> 200 \text{ M}\Omega$ .

#### Measurement

The insulation of the windings against the housing for operation voltages up to 400 V must be measured with 500 V DC. For operating voltages up to 725 V the measurement must be made with 1000 V DC. The temperature of the windings should be  $25^\circ\text{C} \pm 15^\circ\text{C}$ .

#### Testing

If the minimum insulation resistance of the winding against earth is less than  $50 \text{ M}\Omega$ , this may be due to moisture. The windings must then be dried.

The insulation resistance may reduce after long periods of operation. As long as the measured value does not fall below the calculated value for the critical insulation resistance of  $< 50 \text{ M}\Omega$ , operation of the motor may continue. If the value is less than this, the cause must be established and if necessary the windings or parts of the windings must be repaired, cleaned or dried.

### 1.3.10 Commissioning



#### Information

#### Electromagnetic compatibility

NORD motors comply with the EU-Directive 2014/30/EU. Assembly or installation work must not cause impermissible interference. Immunity from interference must still exist.

**Production of interference:** In cases of large differences of torque (e.g. when driving a piston compressor) a non-sine wave motor current is induced, whose harmonics can cause an impermissible effect on the mains and therefore impermissible production of interference.

With supply by frequency inverters, various strengths of interference are produced according to the design of the frequency inverter (type, interference suppression, manufacturer). The EMC information of the inverter manufacturer must be observed. If a shielded motor supply cable is recommended, the shielding is most effective if a large area is electrically connected to the metal terminal box of the motor (with metal EMC cable gland). With motors with integrated sensors (e.g. thermistors) interference voltages due to the inverter may be produced in the sensor cables.

**Interference immunity:** For motors with integrated sensors (e.g. thermistors) the operator must ensure adequate immunity to interference by the selection of a suitable sensor cable (possibly with screening, with connection as for the motor supply cable) and evaluation device. The information and instructions in the operating instructions for the inverter and all other instructions must be observed before commissioning. After installation of the motor, it must be checked for correct functioning. In the case of brake motors, the correct function of the brake must also be checked.

### 1.3.11 Disposal

---

#### **NOTICE**

#### **Environmental damage**

Incorrect disposal of the product may cause damage to the environment.

- Ensure correct disposal
  - Comply with current local regulations
- 

**Content:** aluminium, iron, electronic components, copper

Please observe the additional documentation for the attachments

## 2 Maintenance and servicing

### **DANGER!**

### **Electric shock**

The motor is operated with a dangerous voltage. Touching certain conducting components (connection terminals and supply cables) will cause electric shock with possibly fatal consequences.

Even when the motor is at a standstill (e.g. due to the electronic block of a connected frequency inverter or a jammed drive unit) the connection terminals and supply cables may carry a dangerous voltage. A motor standstill is not identical to electrical isolation from the mains.

Even if the drive unit has been disconnected from the mains, a connected motor may rotate and possibly generate a dangerous voltage.

Installation and work must only be carried out when the motor is at a standstill and is **disconnected** (all phases disconnected from the mains).

Follow the **5 Safety Rules** (1. Switch off the power, 2. Secure against switching on, 3. Check for no voltage, 4. Earthing and short circuiting, 5. Cover or fence off neighbouring live components).

### **WARNING**

### **Injury due to movement**

Under certain conditions (e.g. switching on the power supply, releasing a holding brake) the motor may start to move. The machinery which it drives (press / chain hoist / roller / fan etc.) may then make an unexpected movement. This may cause various injuries, including to third parties.

Before switching on, secure the danger area by warning and removing all persons from the danger area.

### 2.1 Safety measures

Before starting any work on the motor or the device, but especially before opening the covers of active components, the motor must be isolated according to regulations. In addition to the main power circuits, any additional or auxiliary circuits must be taken into account.

The usual "5 Safety Rules" e.g. according to DIN VDE 0105 are:

- Disconnect
- Secure to prevent reactivation
- Check for no voltage on all poles
- Earth and short circuit
- Cover or cordon off adjacent live components

These measures may only be removed when the maintenance work is complete.

Motors must be properly inspected at regular intervals; current national standards and regulations must be complied with. In particular, special attention must be paid to any mechanical damage, free path of the cooling air, abnormal noises and correct electrical connection.

Only original parts may be used as spare parts with the exception of standardised, commercially available and equivalent parts.

Swapping parts between motors of the same type is not permissible.

### **Information**

### **Condensation outlets**

If the motors are designed with closed condensation outlets, these must be opened occasionally in order to allow any accumulated condensation to drain off. Condensation outlets must always be located at the lowest point of the motor. During installation of the motor care must be taken that the condensation outlets point downwards and are closed. Open condensation outlets cause a reduction of the protection class.

Electro~Motor.ir

## 2.2 Bearing replacement periods

Under normal operating conditions, with horizontal motor installation, the bearing replacement period in operating hours [h] for IEC motors is the following depending on the listed coolant temperature and motor speeds:

	25°C	40°C	60°C
to 1.800 rpm	approx. 40,000 h	approx. 20,000 h	approx. 8,000 h
to 3,600 rpm	approx. 20,000 h	approx. 10,000 h	approx. 4,000 h

In case of direct mounting of the gear units or special operating conditions, for example vertical motor installation, high vibration and impact loads, frequent reversing operation, etc., the above-mentioned operating hours can be significantly reduced. The ball bearings are lifelong lubricated.

## 2.3 Maintenance intervals

The motor must be checked for unusual running noises and/or vibrations once a week or every 100 hours of operation.

Please check the roller bearings at a minimum interval of 10,000 h and replace them if necessary. The interval may be shorter depending on the operating conditions.

### NOTICE

#### **Bearing damage during inverter operation**

During inverter operation, bearing currents can occur under unfavourable conditions, which lead to damage of the bearings. Damaging bearing currents can be prevented by appropriate technical measures.

- The effective value of the shaft voltage should not exceed 250 mV.

If necessary, please contact NORD service.

---

Also check the electrical connections, cables, strands and fans for strength and damages. Check the function of the insulation system.

Replace the radial shaft seals every 10,000 h.

There must be no dust deposits on the motor's surface that may impair cooling.

The motor must be completely overhauled at intervals of five years.

## 2.4 General overhaul

The motor must be completely disassembled. The following work must be carried out:

- Clean all motor components
- Examine all motor components for damages
- Replace all damaged components
- Replace all roller bearings
- Replace all seals and radial shaft seals
- Perform a winding insulation resistance measurement



The general overhaul must be carried out by qualified personnel in a specialist workshop with appropriate equipment. We urgently recommend that the general overhaul is carried out by the NORD Service department.



If the drive unit is used in special ambient conditions, the above-mentioned intervals may be significantly shorter.



### 3 ATEX Explosion hazard areas



#### 3.1 Motors with increased ignition protection, type Ex eb

 <b>DANGER!</b>	<b>Explosion hazard</b>
	<p>All work must only be carried out with the machine at a standstill and the <b>power to the system switched off</b>.</p> <p>Higher temperatures than the maximum permitted surface temperature of the housing may be present inside the motor. The motor must therefore never be opened in an explosive atmosphere!</p> <p>Failure to comply with this may result in the ignition of an explosive atmosphere.</p>

 <b>WARNING</b>	<b>Explosion hazard</b>
	<p>Excessively heavy dust deposits must be avoided, as these impair the cooling of the device!</p> <p>Impairment or obstruction of the flow of cooling air, for example due to partial or large area coverage of the fan cover or the entry of foreign bodies fall into the fan must be avoided in order to ensure adequate cooling.</p> <p>Only cable glands and reducers which are approved for use in explosion hazard areas may be used.</p> <p>All cable glands which are not used must be closed with blind screw plugs which are approved for potentially explosive areas.</p> <p>Only the original seals may be used.</p> <p>Failure to comply increases the risk of ignition of an explosive atmosphere.</p>

For these motors, the following information specifically or complementarily apply.

The motors are suitable for use in zone 1 and correspond to device group II, category 2G and may be used at an ambient temperature from -20 °C to +40 °C.

<b>Type suffix:</b>	<b>2G</b>	e.g.:	80 L/4 2G TF
<b>Labelling:</b>	 <b>0102</b>		II 2G Ex eb IIC T3 Gb

<b>NOTICE</b>
<p><b>Motor attachments</b></p> <p>Explosion-protected electric motors are often delivered with attached components and devices, such as a gear unit or a brake.</p> <ul style="list-style-type: none"> <li>In addition to the labelling of the motor, observe any labelling on the attached components and devices. Consider any resulting restrictions for the entire drive.</li> </ul>

Explosive gas mixtures or dust concentrations may cause severe or fatal injuries in combination with hot, electrically live and moving components of electrical machines.

The increased danger in explosion hazard areas requires especially strict observance of the general safety and commissioning information. It is necessary that the persons responsible are qualified according to national and local regulations.

Explosion protected electrical machines with ignition protection class Ex eb correspond to the standard series EN 60034 (VDE 0530), as well as EN IEC 60079-0:2018 and EN IEC 60079-7:2015/A1:2018. The degree of explosion hazards determines zone division. DIN EN 60079, Part 10 provides information about this. The operator is responsible for the zone division. The use of motors which are not certified for explosion hazard areas is prohibited in explosion hazard areas.

### 3.1.1 Cable glands

The cable glands must be approved for explosion hazard areas. Unused openings must be sealed with approved blind plugs. When connecting the installation cables, the connections at the motor terminals and the ground cable with U-shaped cables must be placed below the respective terminals so that the clamping bracket and the clamping bolt are evenly loaded and are not deformed. As an alternative, the connections may be designed with a cable lug. If the cables are subject to increased thermal requirements, this information can be found listed on a label on the motor.

For sizes 63 to 132, an isolated cable lug must be provided, if it is used to connect the earthing cable within the terminal box.

The nuts of the terminal board bolts must be tightened according to the following table.

	Tightening torques for terminal board connections				
	Thread diameter	M4	M5	M6	M8
	Tightening torque (Nm)	1.2	2.0	3.0	6.0

**The use of aluminium connection cables is not permitted.**

### 3.1.2 Cable connections

All motors with ignition protection class Ex eb are delivered with a certified cable gland.

If the provided cable gland is used, cables with circular cable cross-section must be used. The cable gland's lock nuts must be tightened with a torque according to the following table.

	Tightening torques for lock nut				
	Cable gland	M20x1.5	M25x1.5	M32x1.5	M40x1.5
	Tightening torque (Nm)	3.0	6.0	12.0	14.0

Use of reduction adapters according to Directive 2014/34/EU and/or cable glands with ignition protection class Ex eb is permissible. For this, a minimum certified temperature of 80°C is necessary.

When connecting, care must be taken that the permissible air gaps of at least 10 mm and the permissible leakage tracks of at least 12 mm between the electrically live components and components with the same potential as the housing, or between live components are maintained.

Check that the terminal nuts and the screw for the earth lead are tight before closing the terminal box. The terminal box seals and the seals of the cable glands must be correctly seated and must not be damaged.

### 3.1.3 Terminal box cover seals

The terminal box cover gasket is captively mounted on the terminal box cover. Please only use an original seal when replacing the seal.

If the terminal box is opened during installation, maintenance, repair, troubleshooting or overhaul, the terminal box cover must be re-fitted after the work is complete. There must be no dirt on the surface of the seal or the sealing surface of the terminal box frame.

The screws for the terminal box cover must be tightened with a torque according to the list below.

	Tightening torques for terminal box cover screws				
	Thread diameter	M4	M5	M6	M8
	Tightening torque (Nm)	0.8 - 1.2	1.2 - 1.8	1.5 - 2.5	3.0 - 5.0

### 3.1.4 Motor position – special features IM V3, IM V6

If the end of the shaft faces upwards, e.g. version IM V3, IM V6, a cover must be provided by the operator / installer, which prevents foreign bodies from falling into the fan cover of the motor (see EN IEC 60079-0:2018). This must not obstruct the fan from cooling the motor. If the end of the shaft faces downwards (AS, inclination 20° to 90°), e.g. versions IM V1, IM V5, the motors are to be used with a protective cover on the fan cover. For an inclination of less than 20°, an appropriate protective device, which meets the above mentioned conditions, must be provided by the operator / installer.

A hand wheel on the second shaft end is not permitted.

### 3.1.5 Further operating conditions

The motors are designed for continuous operation and normal, non recurring starting, in which no significant starting heat occurs.

Range A in EN 60034-1 (VDE 0530 Part 1) - Voltage  $\pm 5\%$ , Frequency  $\pm 2\%$ , curve form, mains symmetry - must be complied with so that the development of heat remains within the permissible limits. Any major deviations from the rated values can cause an impermissible increase in the development of heat in the motor.

The motor temperature class stated on the type plate must at least conform to the temperature class of any combustible gas that may occur.

When operated on a frequency inverter, damaging bearing currents must be ruled out. This could be caused by excessively high shaft voltages.

If the effective value of the shaft voltage (RMS) exceeds 250 mV, permissible technical measures must be taken. If necessary, please contact the NORD service. Please also pay attention to the relevant PTB data sheets. In addition to further information, details on the permissible frequency characteristic curves can be found here.

### 3.1.6 Protective devices

Each machine must be protected against impermissible heating during all phases by a current-dependent and delayed circuit breaker with phase failure protection according to VDE 0660, functionally tested by a notified body, or by an equivalent effective device. The protective device must be set to the rated current. For windings with a delta circuit, the triggers are connected in series with the phase windings and set to  $0.58 \cdot I_n$  the rated current. If this circuit is not possible, additional protection measures are required (e.g. thermal protection of the machine).

In case of a blocked rotor, the protective device must switch off within the  $t_E$  time specified for the respective temperature class.

Electrical machines for heavy starting (acceleration time  $> 1,7 \cdot t_E$  time) must be protected by a start monitoring device as specified in the EU type-examination certificate.

Thermal protection of the machine by means of direct temperature monitoring of the windings with a PTC resistor temperature sensor is permitted, if this is certified and stated on the rating plate.

Do not apply voltages higher than 30 V to the PTC resistor temperature sensors!

For sole protection by PTC resistor temperature sensors, a functionally tested and certified PTC triggering device of a notified body must be used. The PTC triggering device must have the following protection class labelling:

 II (2) G

Information for motor protection

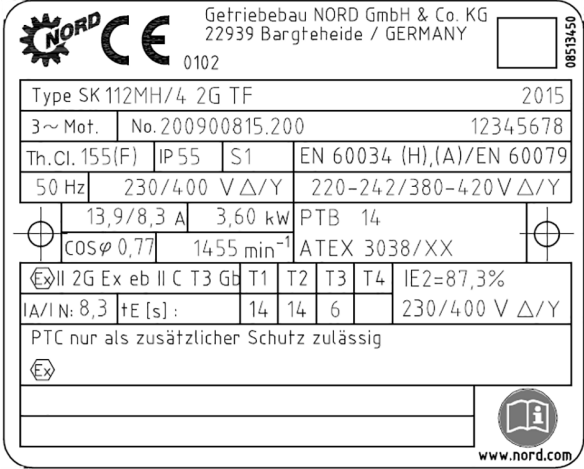
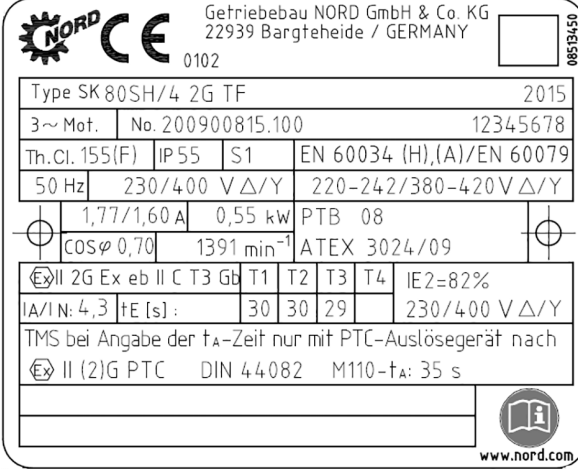
Type plate example: No sole means of protection via temperature sensor	Type plate example: Sole protection via temperature sensor
 <p> <b>Notice! Danger!</b> If the time <math>t_A</math> is <i>not</i> stated on the type plate, the thermistor is <i>not</i> permissible as the sole means of protection  <b>It is essential that the motor is protected with a motor protection relay which has been approved by a testing facility.</b> The motor protection relay must be approved for the ignition protection class which is stated on the motor.         </p>	 <p>A thermistor is permissible as the sole</p>

3.1.7 Operation with frequency inverter

Operation with a frequency inverter must be explicitly certified. The separate manufacturer's information must be observed. The EMC Directive must be complied with.

### 3.1.8 Repairs

Repairs must be carried out by Getriebbau NORD or by an officially recognised expert. The work must be indicated with an additional repair plate. With the exception of standard, commercially available and equivalent components, only original spare parts (see spare parts list) may be used. The particularly applies for seals and connecting components.

For motors with closed condensation outlets, the threads of the closing screws must be coated with Loctite 242 or Loxeal 82-21 after the condensation has been drained. The closing screws must be re-inserted immediately. The electrical connections must be checked at regular intervals.

Check that the connection terminals, and the electrical bonding terminal are firmly fastened. Check that the cable gland and the terminal box gasket are in good condition

All work on electrical machinery must be performed when the machine is at a standstill and with all poles disconnected from the mains.

The motor must be removed for any measurement of the insulation resistance. The measurement must not be performed in the explosion hazard area. As soon as measurement has been completed, discharge the connecting terminals again immediately by shorting them in order to prevent any spark discharges occurring in the explosive area.

 **DANGER!**

#### Explosion hazard



Insulation measurements may cause sparks and therefore ignition of an explosive atmosphere.

- Only perform insulation measurements outside of an explosive atmosphere.
- Discharge the connection terminals by short circuiting them after the measurement and before returning to an explosive atmosphere.

### 3.1.9 Painting

The motors are equipped with a suitable, electrostatically tested painting ex-works. Subsequent painting may only be carried out in consultation with Getriebbau NORD or a repair workshop approved for the repair of explosion-protected electric motors. The valid standards and regulations must be observed.

### 3.1.10 Name plate of NORD Ex eb motors according to EN IEC 60079-0:2018

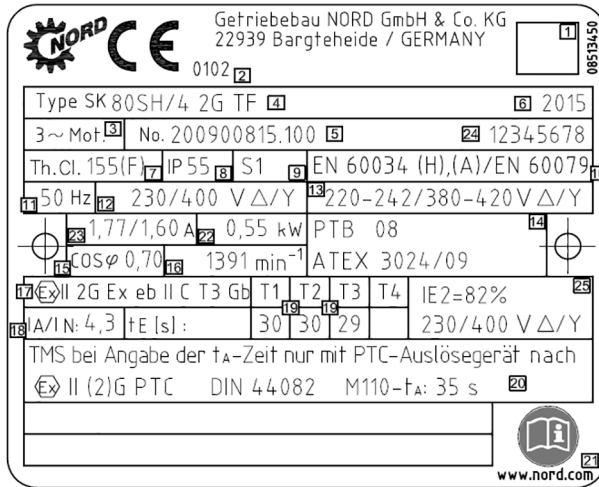

1	Data matrix code
2	Code number of notified body
3	Number of phases
4	Type designation
5	Order number/motor number
6	Year of manufacture
7	Thermal class of insulation system
8	IP protection class
9	Operating mode
10	Standard specifications
11	Nominal frequency
12	Nominal voltage
13	Permissible voltage range
14	EU type-examination certificate number
15	Power factor
16	Speed
17	Explosion protection marking
18	Locked-rotor current/nominal current
19	tE times
20	Note: TMS when indicating the tA time with only PTC triggering device according to:  II (2)G PTC DIN 44082
21	Notice! Pay attention to operating instructions B1091.
22	Nominal power (mechanical shaft power)
23	Nominal current
24	Individual serial number
25	Efficiency

Before commissioning, the type plate must be compared with the requirements of the aforementioned declaration, which result from the local regulations and operating conditions.

#### Explanation of standard specification in rating plate

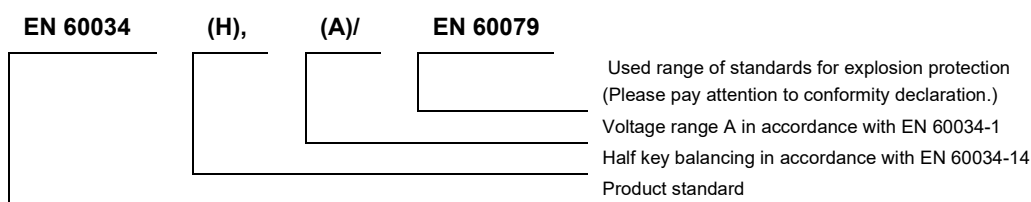

### 3.1.11 Applied standard versions

EN standard	Edition	IEC standard	Edition
EN 60034-7	2001-12	IEC 60034-7	1992+ A1:2000
EN 60034-6	1996-08	IEC 60034-6	1991-09
EN 60079-0	2018	IEC 60079-0	2017
EN 60079-7/A1	2015 /A1: 2018	IEC 60079-7/A1	2015/ 2017
EN 60529	2014-09	IEC 60529	1989/AMD2:2013/COR1:2019

### 3.2 Motors with ignition protection class Non Sparking Ex ec



#### DANGER!

#### Explosion hazard



All work must only be carried out with the machine at a standstill and the **power to the system switched off**.

Higher temperatures than the maximum permitted surface temperature of the housing may be present inside the motor. The motor must therefore never be opened in an explosive atmosphere!

Failure to comply with this may result in the ignition of an explosive atmosphere.



#### WARNING

#### Explosion hazard



Excessively heavy dust deposits must be avoided, as these impair the cooling of the device!

Impairment or obstruction of the flow of cooling air, for example due to partial or large area coverage of the fan cover or the entry of foreign bodies fall into the fan must be avoided in order to ensure adequate cooling.

Only cable glands and reducers which are approved for use in explosion hazard areas may be used.



All cable glands which are not used must be closed with blind screw plugs which are approved for potentially explosive areas.

Only the original seals may be used.

Failure to comply increases the risk of ignition of an explosive atmosphere.

For these motors, the following information specifically or complementarily apply.

The motors are suitable for use in zone 2 and correspond to device group II, category 3G and may be used at an ambient temperature from -20 °C to +40 °C.

<b>Type suffix:</b>	3G	e.g.:	80 L/4 3G TF	
<b>Labelling:</b>			II 3G Ex ec IIC T3 Gc	With indication of the temperature class

### NOTICE

#### Motor attachments

Explosion-protected electric motors are often delivered with attached components and devices, such as a gear unit or a brake.

- In addition to the labelling of the motor, observe any labelling on the attached components and devices. Consider any resulting restrictions for the entire drive.

Explosive gas mixtures or dust concentrations may cause severe or fatal injuries in combination with hot, electrically live and moving components of electrical machines.

The increased danger in explosion hazard areas requires especially strict observance of the general safety and commissioning information. It is essential that the persons responsible are qualified according national and local regulations.

Explosion protected electrical machines with ignition protection class Ex n correspond to the standard series EN 60034 (VDE 0530), as well as IEC 60079-0:2018 and EN IEC 60079-7:2015/A1:2018. The degree of explosion hazards determines zone division. DIN EN 60079, Part 10 provides information about this. The operator is responsible for the zone division. The use of motors which are not certified for explosion hazard areas is prohibited in explosion hazard areas.



### 3.2.1 Cable glands

The cable glands must be approved for explosion hazard areas. Unused openings must be sealed with approved blind plugs. When connecting the installation cables, the connections at the motor terminals and the ground cable with U-shaped cables must be placed below the respective terminals so that the clamping bracket and the clamping bolt are evenly loaded and are not deformed. As an alternative, the connections may be designed with a cable lug. If the cables are subject to increased thermal requirements, this information can be found listed on a label on the motor.

For sizes 63 to 132, an isolated cable lug must be provided, if it is used to connect the earthing cable within the terminal box.

The nuts of the terminal board bolts must be tightened according to the following table.

	Tightening torques for terminal board connections				
	Thread diameter	M4	M5	M6	M8
	Tightening torque (Nm)	1.2	2.0	3.0	6.0

**The use of aluminium connection cables is not permitted.**

### 3.2.2 Cable connections

If the provided cable gland is used, cables with circular cable cross-section must be used. The cable gland's lock nuts must be tightened with a torque according to the following table.

	Tightening torques for lock nut				
	Cable gland	M20x1.5	M25x1.5	M32x1.5	M40x1.5
	Tightening torque (Nm)	3.0	6.0	12.0	14.0

Use of reduction adapters according to Directive 2014/34/EU and/or cable glands with ignition protection class Ex ec is permissible. For this, a minimum certified temperature of 80°C is necessary.

When connecting, care must be taken that the permissible air gaps of at least 10 mm and the permissible leakage tracks of at least 12 mm between the electrically live components and components with the same potential as the housing, or between live components are maintained.

Check that the terminal nuts and the screw for the earth lead are tight before closing the terminal box. The terminal box seals and the seals of the cable glands must be correctly seated and must not be damaged.

### 3.2.3 Terminal box cover seals

The terminal box cover gasket is captively mounted on the terminal box cover. Please only use an original seal when replacing the seal.

If the terminal box is opened during installation, maintenance, repair, troubleshooting or overhaul, the terminal box cover must be re-fitted after the work is complete. There must be no dirt on the surface of the seal or the sealing surface of the terminal box frame.

The screws for the terminal box cover must be tightened with a torque according to the list below.

	Tightening torques for terminal box cover screws				
	Thread diameter	M4	M5	M6	M8
	Tightening torque (Nm)	0.8 - 1.2	1.2 - 1.8	1.5 - 2.5	3.0 – 5.0

### 3.2.4 Motor position – special features IM V3, IM V6

If the end of the shaft faces upwards, e.g. version IM V3, IM V6, a cover must be provided by the operator / installer, which prevents foreign bodies from falling into the fan cover of the motor (see EN IEC 60079-0:2018). This must not obstruct the fan from cooling the motor. If the end of the shaft faces downwards (AS, inclination 20° to 90°), e.g. versions IM V1, IM V5, the motors are to be used with a protective cover on the fan cover. For an inclination of less than 20°, an appropriate protective device, which meets the above mentioned conditions, must be provided by the operator / installer.

A hand wheel on the second shaft end is not permitted.

### 3.2.5 Further operating conditions

The motors are designed for continuous operation and normal, non recurring starting, in which no significant starting heat occurs.

Range A in EN 60034-1 (VDE 0530 Part 1) - Voltage  $\pm 5\%$ , Frequency  $\pm 2\%$ , curve form, mains symmetry - must be complied with so that the development of heat remains within the permissible limits. Any major deviations from the rated values can cause an impermissible increase in the development of heat in the motor.

The motor temperature class stated on the type plate must at least conform to the temperature class of any combustible gas that may occur.

When operated on a frequency inverter, damaging bearing currents must be ruled out. This could be caused by excessively high shaft voltages.

If the effective value of the shaft voltage (RMS) exceeds 250 mV, permissible technical measures must be taken. If necessary, please contact the NORD service. Please also pay attention to the relevant PTB data sheets. In addition to further information, details on the permissible frequency characteristic curves can be found here.

### 3.2.6 Protective devices

Protective devices must be adjusted to the rated current. For windings with a delta circuit, the triggers are connected in series with the windings and adjusted to 0.58x the rated current.

Alternatively, the motors can be protected with thermistor temperature sensors. Protection with thermistor temperature sensors is mandatory for inverter operation.

Do not apply voltages greater than 30 V to the thermistor temperature sensor.

We recommend the use of a functionally tested, certified PTC trigger device for protection with a thermistor temperature sensor.

**The following standards must be observed for the installation of electrical systems in explosion hazard areas in Germany: DIN EN 60079-14 (VDE 0165-1), the Technical Rules for Operating Safety (TRBS), the Operating Safety Regulations (BetrSichV), the Hazardous Substances Regulation (GefStoffV) as well as the Explosion Protection Regulations (Ex-RL). Other regulations must be observed if applicable. The applicable national regulation must be observed outside of Germany.**

### 3.2.7 Repairs

Repairs must be carried out by Getriebebau NORD or by an officially recognised expert. The work must be indicated with an additional repair plate. With the exception of standard, commercially available and equivalent components, only original spare parts (see spare parts list) may be used. The particularly applies for seals and connecting components.

For motors with closed condensation outlets, the threads of the closing screws must be coated with Loctite 242 or Loxeal 82-21 after the condensation has been drained. The closing screws must be re-inserted immediately. The electrical connections must be checked at regular intervals.

Check that the connection terminals, and the electrical bonding terminal are firmly fastened. Check that the cable gland and the terminal box gasket are in good condition

All work on electrical machinery must be performed when the machine is at a standstill and with all poles disconnected from the mains.

The motor must be removed for any measurement of the insulation resistance. The measurement must not be performed in the explosion hazard area. As soon as measurement has been completed,

discharge the connecting terminals again immediately by shorting them in order to prevent any spark discharges occurring in the explosive area.

 **DANGER!**

**Explosion hazard**



Insulation measurements may cause sparks and therefore ignition of an explosive atmosphere.

- Only perform insulation measurements outside of an explosive atmosphere.
- Discharge the connection terminals by short circuiting them after the measurement and before returning to an explosive atmosphere.

### 3.2.8 Painting

The motors are equipped with a suitable, electrostatically tested painting ex-works. Subsequent painting may only be carried out in consultation with Getriebbau NORD or a repair workshop approved for the repair of explosion-protected electric motors. The valid standards and regulations must be observed.

### 3.2.9 Type plate for NORD Ex ec motors according to EN IEC 60079-0:2018

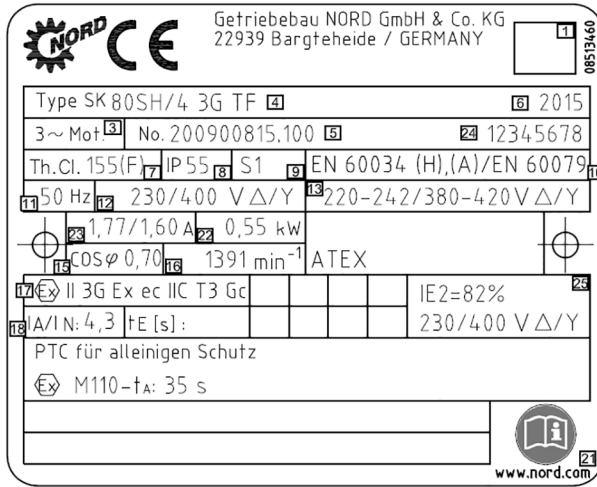

1	Data matrix code
3	Number of phases
4	Type designation
5	Order number/motor number
6	Year of manufacture
7	Thermal class of insulation system
8	IP protection class
9	Operating mode
10	Standard specifications
11	Nominal frequency
12	Nominal voltage
13	Permissible voltage range
15	Power factor
16	Speed
17	Explosion protection marking
18	Locked-rotor current/nominal current
21	Notice! Pay attention to operating instructions B1091.
22	Nominal power (mechanical shaft power)
23	Nominal current
24	Individual serial number
25	Efficiency

Before commissioning, the type plate must be compared with the requirements of the aforementioned declaration, which result from the local regulations and operating conditions.

#### Explanation of standard specification in rating plate

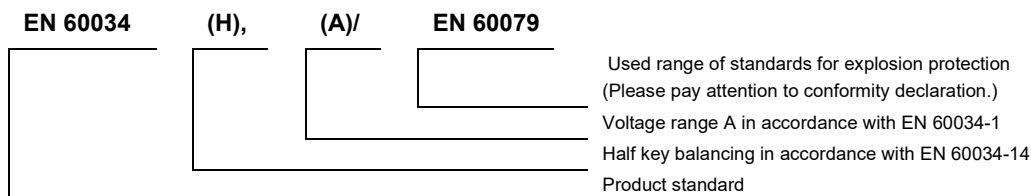

### 3.2.10 Applied standard versions

EN standard	Edition	IEC standard	Edition
EN 60034-7	2001-12	IEC 60034-7	1992+ A1:2000
EN 60034-6	1996-08	IEC 60034-6	1991-09
EN 60079-0	2018	IEC 60079-0	2017
EN 60079-7/A1	2015 /A1: 2018	IEC 60079-7/A1	2015/ 2017
EN 60529	2014-09	IEC 60529	1989/AMD2:2013/COR1:2019

### 3.3 Motors for use in Zone 21 and Zone 22 according to EN 60079 and IEC 60079

#### DANGER!

#### Explosion hazard



All work must only be carried out with the machine at a standstill and the **power to the system switched off**.

Higher temperatures than the maximum permitted surface temperature of the housing may be present inside the motor. The motor must therefore never be opened in an explosive atmosphere!

Failure to comply with this may result in the ignition of an explosive atmosphere.

#### WARNING

#### Explosion hazard



Excessively heavy dust deposits must be avoided, as these impair the cooling of the device!

Impairment or obstruction of the flow of cooling air, for example due to partial or large area coverage of the fan cover or the entry of foreign bodies fall into the fan must be avoided in order to ensure adequate cooling.

Only cable glands and reducers which are approved for use in explosion hazard areas may be used.





All cable glands which are not used must be closed with blind screw plugs which are approved for potentially explosive areas.

Only the original seals may be used.

Failure to comply increases the risk of ignition of an explosive atmosphere.

For these motors, the following information specifically or complementarily apply.

Motors which comply with EN 60079 and IEC 60079 are suitable according to their labelling for use in zone 21 or zone 22 - non-conductive dust.

<b>Type suffix:</b>					
According to EN 60079	<b>Zone 21</b>	<b>2D</b>	e.g.:	80 L/4 2D TF	
	<b>Zone 22</b>	<b>3D</b>	e.g.:	80 L/4 3D TF	
According to IEC 60079	<b>Zone 21</b>	<b>EPL Db</b>	e.g.:	80 L/4 IDB TF	
	<b>Zone 22</b>	<b>EPL Dc</b>	e.g.:	80 L/4 IDC TF	
<b>Labelling:</b>					
According to IEC 60079 and 2014/34 EU			0102	II 2D Ex tb IIIC T125°C Db	For category 2 (zone 21) <sup>1)</sup>
				II 3D Ex tc IIIB T125°C Dc	For category 3 (zone 22 – non-conducting dust) <sup>1)</sup>
According to IEC 60079				EX tb IIIC T125°C Db	For category 2 <sup>1)</sup>
				Ex tc IIIB T125°C Dc	For category 3 (zone 22 – non-conducting dust) <sup>1)</sup>

1) The indicated surface temperature may deviate from 125 °C and can be found on the name plate.

**NOTICE****Motor attachments**

Explosion-protected electric motors are often delivered with attached components and devices, such as a gear unit or a brake.

- In addition to the labelling of the motor, observe any labelling on the attached components and devices. Consider any resulting restrictions for the entire drive.

**DANGER****Explosion hazard**

The increased danger in areas with flammable dust requires the strict consideration of the general safety and commissioning information. Explosive concentrations of dust may cause explosions if ignited by hot or sparking objects. Such explosions may cause serious or fatal injuries to persons or severe material damage.

It is essential that the persons responsible are qualified according to the national and local regulations.

**3.3.1 Commissioning information / Application area**

If the motors are to be suitable for inverter operation, this must be indicated when placing the order. The additional operating instructions B1091-1 must be observed. The motors must be protected against overheating with suitable monitoring devices! The dust deposit must not be thicker than 5 mm. The motors are designed for voltage and frequency range B of EN 60034, part 1.

Exception: The motors of sizes 132MA/4 2D, 132MA/4 3D, 132LH/4 2D and 132LH/4 3D correspond to voltage and frequency range A.

Motors for use in Zone 21 and Zone 22 with TF labelling may be thermally monitored – as sole protection – via the installed PTC in combination with a suitable triggering device.

Electrical equipment for use in areas with flammable dust comply with the DIN EN 60079-0, IEC 60079-0, EN 60079-31, IEC 60079-31, DIN EN 60034 and IEC 60034 standards.

The standard's valid version can be found in the EU Declaration of Conformity or in the IECEx CoC. The degree of explosion hazards determines zone division. The operator/employer is responsible for zone division (in Europe: RL 1999/92/EC).

If an X has been added to the certificate, special requirements must be observed in the EU type-examination certificate, the IECEx CoC and/or the documentation to be considered. It is prohibited to use standard motors that are not certified for explosion hazard areas in explosion hazard areas.

### 3.3.2 Terminal box cover seals

The terminal box cover gasket is captively mounted on the terminal box cover. Please only use an original seal when replacing the seal.

If the terminal box is opened during installation, maintenance, repair, troubleshooting or overhaul, the terminal box cover must be re-fitted after the work is complete. There must be no dirt on the surface of the seal or the sealing surface of the terminal box frame.

The screws for the terminal box cover must be tightened with a torque according to the list below.

	Tightening torques for terminal box cover screws				
	Thread diameter	M4	M5	M6	M8
	Tightening torque (Nm)	0.8 - 1.2	1.2 - 1.8	1.5 - 2.5	3.0 - 5.0

### 3.3.3 Electrical Connection

The electrical connections of the terminal board are protected against twisting. The voltage supply to the terminal board must be made by means of suitable ring terminals. The ring terminals are installed between the two brass washers below the lock washer. The nuts must be tightened with a torque according to the table below. The contact pressure is permanently maintained by means of the specified torque and the lock washer. In addition, twisting of the ring terminals of the voltage supply is prevented. The connection elements are corrosion-proof.

	Tightening torques for terminal board connections				
	Thread diameter	M4	M5	M6	M8
	Tightening torque (Nm)	0,8 - 1,2	1,8 - 2,5	2,7 - 4,0	5,5 - 8,0

#### Exploded diagram of electrical connection

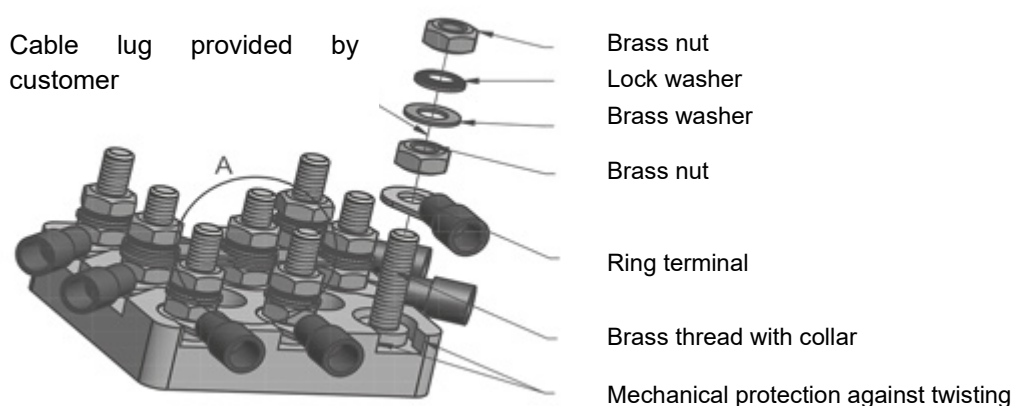



### 3.3.4 Cable glands

Cable glands must be approved for explosion hazard areas of Zone 21 (protection class: at least IP66) and be secured against self-loosening. Unused openings must be sealed with approved plugs (protection class: at least IP66).

For Zone 22, cable glands according to EN 60079-0 and IEC 60079-0 must comply with at least one protection class that is indicated on the name plate. Unused openings must be sealed with blind plugs that comply with at least the motor protection class as well as with the requirements according to EN 60079-0 and IEC 60079-0. The cable and blind plugs must be suitable for temperatures of at least 80°C.

In order to connect cables or carry out other works, the motor must not be opened in explosive atmospheres. The voltage must always be switched off and secured against switch-on before opening.

The motors are equipped with threads for cable glands according to the following overview.

Assignment of cable gland to motor size												
Standard motor cable glands							Braking motor cable glands					
Type	Quantity	Threads	Quantity	Threads	Quantity	Threads	Quantity	Threads	Quantity	Threads	Quantity	Threads
63	2	M20x1.5					4	M20x1.5	2	M12x1.5		
71	2	M20x1.5					4	M20x1.5	2	M12x1.5		
80	2	M25x1.5					4	M25x1.5	2	M12x1.5		
90	2	M25x1.5					4	M25x1.5	2	M12x1.5		
100	2	M32x1.5					4	M32x1.5	2	M12x1.5		
112	2	M32x1.5					4	M32x1.5	2	M12x1.5		
132	2	M32x1.5					4	M32x1.5	2	M12x1.5	2	M16x1.5
160/ 180/..X	2	M40x1.5	2	M12x1.5	2	M16x1.5	2	M40x1.5	2	M12x1.5	2	M16x1.5
180/ 200/..X	2	M40x1.5	2	M12x1.5	2	M16x1.5	2	M40x1.5	2	M12x1.5	2	M16x1.5
225	2	M50x1.5	2	M12x1.5	2	M16x1.5	2	M50x1.5	2	M12x1.5	2	M16x1.5
250 WP	2	M63x1.5	2	M12x1.5	2	M16x1.5	2	M63x1.5	2	M12x1.5	2	M16x1.5

If the motor is supplied with a certified cable gland, the cable gland's lock nuts must be tightened with a torque according to the following table.

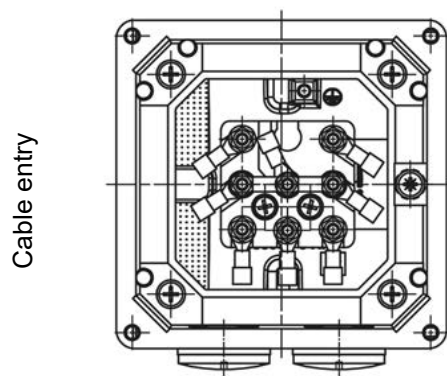

	Tightening torques for lock nut						
	Cable gland	M20x1.5	M25x1.5	M32x1.5	M40x1.5	M50x1.5	M63x1.5
	Tightening torque (Nm)	3.0	6.0	12.0	14.0	20.0	25.0

### 3.3.5 Permissible ambient temperature range

For all motors, the permissible ambient temperature range is  $-20^{\circ}\text{C}$ ... $+40^{\circ}\text{C}$ . For IE1/IE2 motors for operation in Zones 21 and 22, an extended ambient temperature range from  $-20^{\circ}\text{C}$ ... $+60^{\circ}\text{C}$  is permissible. In this case, the rated power must be reduced to **72%** of the value stated in the catalogue.

If the maximum ambient temperature is between  $+40^{\circ}\text{C}$  and  $+60^{\circ}\text{C}$ , the power output should be inversely linearly interpolated between **100%** and **72%**. Thermal motor protection by PTC resistor temperature sensors is mandatory. The motor connection cables and the cable glands must be suitable for temperatures of at least  $80^{\circ}\text{C}$ .

The extended ambient temperature range does not apply for optional attachments such as a brake, an encoder and/or an external fan. Contact the manufacturer in case of doubt with regard to permissibility!

### 3.3.6 Painting

The motors are equipped with a suitable, electrostatically tested painting ex-works. Subsequent painting may only be carried out in consultation with Getriebebau NORD or a repair workshop approved for the repair of explosion-protected electric motors. The valid standards and regulations must be observed.

### 3.3.7 IEC-B14 motors

Please comply with the information in Section 1.3.2. Otherwise, explosion protection is not ensured.

### 3.3.8 Motor position – special features IM V3, IM V6

If the end of the shaft faces upwards, e.g. version IM V3, IM V6, a cover must be provided by the operator / installer, which prevents foreign bodies from falling into the fan cover of the motor (see EN IEC 60079-0:2018). This must not obstruct the fan from cooling the motor. If the end of the shaft faces downwards (AS, inclination  $20^{\circ}$  to  $90^{\circ}$ ), e.g. versions IM V1, IM V5, the motors are to be used with a protective cover on the fan cover. For an inclination of less than  $20^{\circ}$ , an appropriate protective device, which meets the above mentioned conditions, must be provided by the operator / installer.

A hand wheel on the second shaft end is not permitted.

### 3.3.9 Further operating conditions

If nothing is stated to the contrary regarding operating mode and tolerances, electrical machines are designed for continuous operation and normal infrequent starts, where there is no significant start-up warming. The motors must only be used for the operating mode indicated on the rating plate.

**The installation regulations must be observed!**

### 3.3.10 Design and operating principle

The motors are self-cooled. Radial shaft seals are used on the drive side (AS) as well as on the ventilation side (BS). Motors for Zones 21 and 22 have a metal fan. Motors with brakes intended for Zone 22 (Category 3D, non-conducting dust) have a special plastic fan. The motors have been designed with protection class IP55, optionally with protection class IP66 (Zone 22 - non-conducting dust, EPL Dc) or IP66 (Zone 21, EPL Db). The surface temperature does not exceed the surface temperature indicated on the name plate. The prerequisite is the consideration of the operating instructions.

### 3.3.11 Minimum cross section of bonding conductors

Cross section of the phase conductor of the installation S [mm <sup>2</sup> ]	Minimum cross section of the associated protective conductor S <sub>p</sub> [mm <sup>2</sup> ]
S ≤ 16	S
16 < S ≤ 35	16
S > 35	0.5 S

### 3.3.12 Maintenance

**The voltage must always be switched off and secured against switch-on before opening.**

**Notice! Temperatures may occur within the motor that are higher than the maximum permissible surface temperature of the housing. The motor must therefore not be opened in an explosive dust atmosphere. The motors must be checked and tested for functional safety on a regular basis. The valid national standards and regulations must be observed.**

Impermissibly high dust deposits > 5 mm are to be avoided. The motor must not be further operated if functional safety is not guaranteed. Upon replacement of the ball bearings, the radial shaft seals must also be replaced. Please use the radial shaft seals prescribed by Getriebebau NORD. It is essential to pay attention to professional installation. The radial shaft seal's outer ring and sealing lip must be lubricated. If an explosion-protected gear unit is flanged to the motor in a dust-proof manner, a NBR radial shaft seal may be used on the motor's A side if the gear oil temperature does not exceed 85°C. Only original parts may be used as spare parts, except for standardised, customary and equivalent parts. This is particularly valid for seals and connection parts. In case of terminal box parts or spare parts for outer earthing, the parts must be ordered according to the spare parts list of the operating instructions.

Seals, radial shaft seals and cable glands must be checked for functionality on a regular basis.

**The maintenance of the motor's dust protection is of outstanding importance for explosion protection.** Maintenance must be carried out by qualified personnel in a specialist workshop with appropriate equipment. We urgently recommend that the general overhaul is carried out by the NORD Service department.

### 3.4 Options for motors for use in Zone 21 and Zone 22



**DANGER!**

#### Explosion hazard



All work must only be carried out with the machine at a standstill and the **power to the system switched off**.

Higher temperatures than the maximum permitted surface temperature of the housing may be present inside the motor. The motor must therefore never be opened in an explosive atmosphere!

Failure to comply with this may result in the ignition of an explosive atmosphere.



**WARNING**

#### Explosion hazard



Excessively heavy dust deposits must be avoided, as these impair the cooling of the device!

Impairment or obstruction of the flow of cooling air, for example due to partial or large area coverage of the fan cover or the entry of foreign bodies fall into the fan must be avoided in order to ensure adequate cooling.

Only cable glands and reducers which are approved for use in explosion hazard areas may be used.

All cable glands which are not used must be closed with blind screw plugs which are approved for potentially explosive areas.

Only the original seals may be used.

Failure to comply increases the risk of ignition of an explosive atmosphere.

#### 3.4.1 Operation with frequency inverters

ATEX NORD motors with ignition protection classes tb and tc are suitable by their insulation system design for operation with the frequency inverter. The variable speed range requires temperature monitoring using PTC resistors. For safe planning and application, the planning guideline for operating and installation instructions [B1091-1](#) must be observed. The planning guideline provides information on the necessary prerequisites with inverter operation and on the approved speed ranges. Option Z (Heavy fan, cast-iron fan) is not permitted for inverter operation.

If the frequency inverter is not approved for operation within the specified explosion hazard zone, the frequency inverter is to be installed outside the explosion hazard area.

### 3.4.2 External fan

Motors having the additional labelling F (e.g. 80LP/4 3D TF F) are equipped with an external fan and have to be monitored via the installed temperature sensor.



#### WARNING

#### Explosion hazard



The motor may only be commissioned together with the external fan. A failure of the external fan may lead to overheating of the motor and thus to material damage and/or personal injury or even the ignition of an explosive atmosphere.

Observe the operating instructions of the external fan!

The external fan is separately supplied with voltage via the external fan's terminal box. The external fan's supply voltage must match the voltage information indicated on the name plate. Suitable monitoring devices shall protect the external fan against overheating. The IP protection classes of the external fan and the motor may deviate. The lower IP protection class applies to the drive unit. The cable glands must at least match the protection class indicated on the name plate. Unused openings must be sealed with blind plugs that comply with at least the motor protection class.

External fans and motors for use in explosion hazard areas have Ex labelling according to RL 2014/34/EU. The label must be available on the external fan and on the motor. If the labels deviate between external fan and motor, the lower labelled explosion protection applies to the entire drive. If the surface temperature is indicated, the indicated maximum temperature of the individual component applies to the entire drive unit. In this context, any existing gear unit must be observed. Please contact Getriebbau NORD in case of uncertainties. If any one component of the entire drive has no Ex labelling, the entire drive must not be commissioned in explosion hazard areas.

### **3.4.3 Second temperature sensor 2TF**

Category 3D motors (Zone 22, non-conducting dust) can be supplied with a second temperature sensor (2TF). This option can be used to implement a warning signal (overheating in the winding). It should be noted that the temperature sensor with the lower trigger temperature should be used for the warning; the temperature sensor with the higher trigger temperature must be used to evaluate the switch-off signal.

### **3.4.4 Back stop**

Motors having the additional labelling RLS (e.g. 80LP/4 3D **RLS**) are equipped with a back stop. For motors with back stop, the direction of rotation is marked by an arrow on the fan cover. The arrow head points to the drive shaft's direction of rotation (AS). When connecting the motor and during motor control, it must be ensured – for example by testing the field of rotation – that the motor can only operate in the direction of rotation. Switching the motor into the blocked direction of rotation, i.e. the wrong direction of rotation, may cause damage.

Back stops work from a speed of approx. 800 min<sup>-1</sup> without wear. To avoid impermissible heating and faster wear of the back stop, back stops must not be operated with a speed below 800 min<sup>-1</sup>. This must be observed for motors having a frequency of 50 Hz and a pole number of  $\geq 8$  as well as for motors used with a frequency inverter.

### **3.4.5 Brake**

Motors having the additional labelling BRE (e.g. 80LP/4 3D **BRE 10**) are equipped with a brake and have to be monitored via the installed temperature sensors. The triggering of the temperature sensor of one of the components (motor or brake) must lead to safe shut-down of the entire drive. The PTC resistors of motor and brake must be connected in series.

If the motor is operated via a frequency inverter, an external fan must be used in the case of stator supply frequencies below 25 Hz. Operation without an external fan in case of stator supply frequencies below 25 Hz is not permitted.

The brake may be used as a holding brake with up to 4 switching cycles per hour.

An optional manual brake release (with lockable manual release lever, where required) must only be used if there is no explosive dust atmosphere.

#### **NOTICE! Also observe the operating instructions of the brake!**

The DC voltage supply of the brake is realised via a rectifier in the motor terminal box or via direct supply with DC voltage. The brake voltage indicated on the name plate must be complied with.

The power supply lines and the temperature sensor line must not be installed together in one cable. Check the brake's functionality before commissioning. There must be no grinding noises as impermissible heating may occur.

### 3.4.6 Incremental encoder

Motors with the additional labelling **IG** or **IGK** (e.g. 80LP/4 3D IG F) are equipped with an incremental encoder, which is suitable for ignition protection Ex tc. This option is always delivered with an external fan, which is also suitable for ignition protection Ex tc. Operation of the motor is only permissible if the external fan is connected.

#### NOTICE

##### **Malfunction of the drive during operation with connected incremental encoder**

If the motor is operated with a connected incremental encoder, there is a risk of a motor malfunction due to faulty connection and impermissible operating conditions of the incremental encoder.

Therefore, it is mandatory to note before commissioning

- the operating instructions of the incremental encoder with the corresponding installation and maintenance regulations,
- the maximum permissible speed of the incremental encoder,
- the information label attached to the incremental encoder,
- the superordinate motor name plate and possibly the restricting information.

If the operating instructions are not available, contact the Getriebebau NORD service department.

### 3.4.7 Overview of brake attachment for NORD ATEX motors

Permissible brake sizes for Category 3D motors									
Size	LKZ	Braking torques [Nm]							
63	S, L, SP, LP	5							
71	S, L, SP, LP	5							
80	S, SH, SP	5	10						
80	L, LH, LP	5	10						
90	S, SH, SP		10	20					
90	L, LH, SP		10	20					
100	L, LH, LP			20	40				
100	LA, AH, AP			20	40				
112	M, SH, MH, MP			20	40				
132	S, SH, SP					60			
132	M, MH, MP					60			
132	MA					60			
160	MH, MP						100	150	250
160	LH, LP						100	150	250
180	MH, MP								250
180	LH, LP								250
200	XH								250
225	SP, MP								400
250	WP								400

Electro~Motor.ir



3.4.8 Name plate of motors (Ex tb, Ex tc) according to EN 60079 for FI operation

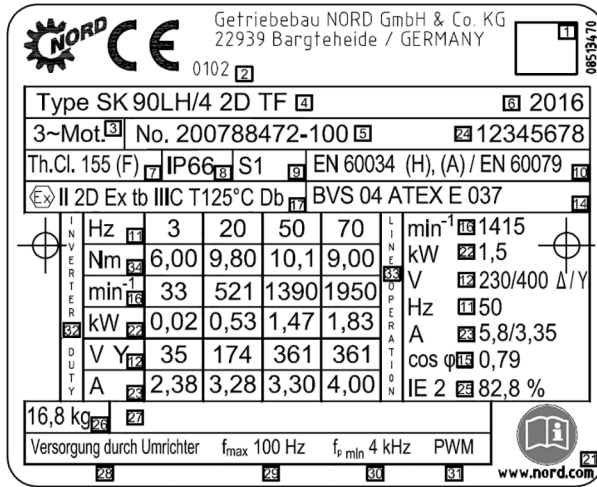

Name plate example Ex tb

1	Data matrix code
2	Code number of notified body (only for Ex tb)
3	Number of phases
4	Type designation
5	Order number/motor number
6	Year of manufacture
7	Thermal class of insulation system
8	IP protection class
9	Operating mode
10	Standard specifications
11	Stator frequency
12	Stator voltage
14	EU type-examination certificate number
15	Power factor
16	Speed
17	Explosion protection marking
21	Notice! Pay attention to operating instructions B1091.
22	Nominal power (mechanical shaft power)
23	Nominal current in operating point
24	Individual serial number
25	Efficiency
26	Weight
27	Information on brake (option with Ex tc only)
28	Note: Supply by frequency inverter
29	Maximum permitted stator frequency
30	Minimum pulse frequency of frequency inverter
31	Modulation procedure of frequency inverter
32	Data field for operation with frequency inverters
33	Data field for mains operation
34	Nominal torque on the motor shaft

Before commissioning, the type plate must be compared with the requirements of the aforementioned declaration, which result from the local regulations and operating conditions.

### 3.5 Motors according to TP TC012/2011 for the Eurasian Economic Union



ATTENTION! EAC Ex motors are no longer available after July, 01th 2023!

In addition to the information which is stated in the operating and maintenance instruction B1091, the following information must be noted for EAC EX motors. If the motor is supplied with further components or devices, the associated operating and maintenance instructions must also be observed.

#### 3.5.1 Type plates / Labelling

Motors with the labelling listed below have EAC Ex approval according to TP TC 012/2011 for the Eurasian Economic Union.

These motors have two type plates. One type plate complies with ATEX Directive 2014/34 EU and the relevant standards from the standard series EN 60079; the second type plate contains the additional specifications according to Directive TP TC 012/2011.



The motors may only be operated in areas in which the ignition protection type stated on the motor type plate is permissible. In addition, compliance with the temperature class and the maximum surface temperature as stated on the type plate is mandatory.

### 3.5.2 Standards

ГОСТ Standard	IEC Standard
ГОСТ 31610.0-2014	IEC 60079-0:2011
ГОСТ Р МЭК 60079-31-2013	IEC 60079-31:2013
ГОСТ Р МЭК 60079-7-2012	IEC 60079-7:2006
ГОСТ 31610.15-2014	IEC 60079-15:2010

### 3.5.3 Service life

In addition to the service intervals which are stated in the operating and maintenance instructions, it should be noted that the use of motors which are more than 30 years old is not permitted.

The year of manufacture of the motor is stated on the type plate.



#### WARNING

#### Danger to persons

The motors must be disconnected from the mains before opening the terminal box.



#### WARNING

#### Explosion hazard

Opening the terminal box in an explosive atmosphere is prohibited.

### 3.5.4 Special operating conditions (X-labelling)

#### Permissible ambient temperature range

For all motors with ignition protection type tb or tc, the permissible ambient temperature range is -20°C...+40°C. For IE1/IE2 motors for operation in Zones 21 and 22, an extended ambient temperature range from -20°C...**+60°C** is permissible. In this case, the rated power must be reduced to **72 %** of the value stated in the catalogue.

If the maximum ambient temperature is between +40°C and +60°C, the power output should be inversely linearly interpolated between **100 %** and **72 %**. Thermal motor protection by PTC resistor temperature sensors is mandatory. The motor connection cables and the cable glands must be suitable for temperatures of at least 80°C.

The extended ambient temperature range does not apply for optional attachments such as a brake, an encoder and/or an external fan. Contact the manufacturer in case of doubt with regard to permissibility!

### 3.6 Motors according to GB 12476.1-2013 / GB 12476.5-2013 for the People's Republic of China

In addition to the information which is stated in the operating and maintenance instructions B1091 and B1091-1, the following information must be noted for the C2D and C3D versions of explosion-protected NORD electric motors.

If the motor is supplied with further components or devices, the associated operating and maintenance instructions must also be observed.

#### 3.6.1 Type plates / Labelling

Motors with CC Ex approval are certified according to the Chinese standards GB12476.1-2013 and GB12476.5-2013. The motors have two name plates and are labelled according to the Chinese and European standards.

Motor type	Labelling according to GB standard	Labelling according to ATEX
C2D	Ex tD A21 IP6X T***°C	Ex II 2D Ex tb IIIC T ***°C Db
C3D	Ex tD A22 IP5X T***°C	Ex II 3D Ex tc IIIB T ***°C Dc

Name plate examples for the labelling of NORD CCCEX motors according to the Chinese standard.

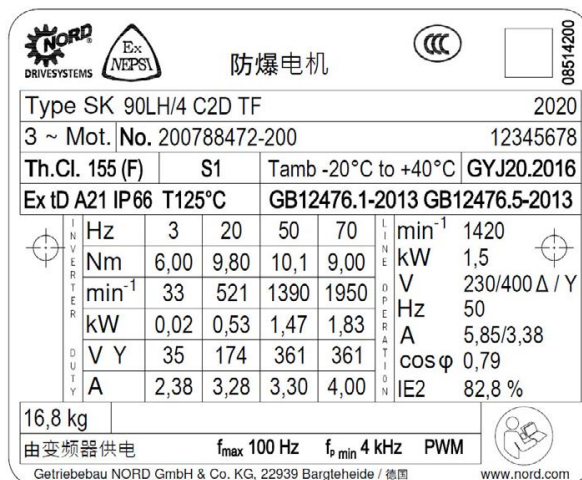

**防爆电机** (Explosion-protected motor)

Type SK 90LH/4 C2D TF 2020  
 3 ~ Mot. No. 200788472-200 12345678

Th.Cl. 155 (F) S1 Tamb -20°C to +40°C GYJ20.2016  
 Ex tD A21 IP66 T125°C GB12476.1-2013 GB12476.5-2013

Hz	3	20	50	70	min <sup>-1</sup>	1420
Nm	6,00	9,80	10,1	9,00	kW	1,5
min <sup>-1</sup>	33	521	1390	1950	V	230/400 Δ / Y
kW	0,02	0,53	1,47	1,83	Hz	50
V Y	35	174	361	361	A	5,85/3,38
A	2,38	3,28	3,30	4,00	cos φ	0,79
					IE2	82,8 %

16,8 kg  
 由变频器供电 f<sub>max</sub> 100 Hz f<sub>p min</sub> 4 kHz PWM  
 Getriebefabrik NORD GmbH & Co. KG, 22939 Bargteheide / 德国 www.nord.com

Name plate example C2D

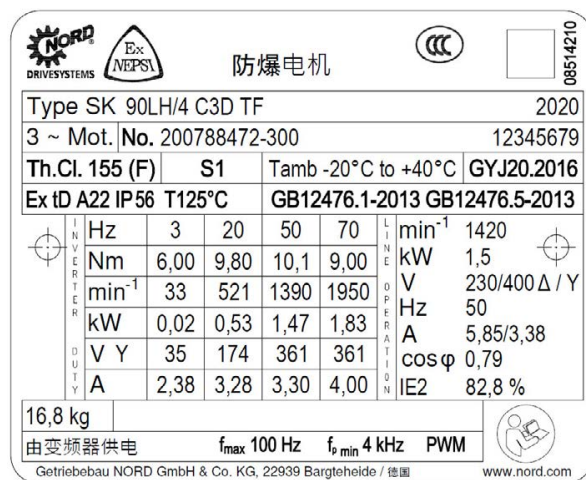

**防爆电机** (Explosion-protected motor)

Type SK 90LH/4 C3D TF 2020  
 3 ~ Mot. No. 200788472-300 12345679

Th.Cl. 155 (F) S1 Tamb -20°C to +40°C GYJ20.2016  
 Ex tD A22 IP56 T125°C GB12476.1-2013 GB12476.5-2013

Hz	3	20	50	70	min <sup>-1</sup>	1420
Nm	6,00	9,80	10,1	9,00	kW	1,5
min <sup>-1</sup>	33	521	1390	1950	V	230/400 Δ / Y
kW	0,02	0,53	1,47	1,83	Hz	50
V Y	35	174	361	361	A	5,85/3,38
A	2,38	3,28	3,30	4,00	cos φ	0,79
					IE2	82,8 %

16,8 kg  
 由变频器供电 f<sub>max</sub> 100 Hz f<sub>p min</sub> 4 kHz PWM  
 Getriebefabrik NORD GmbH & Co. KG, 22939 Bargteheide / 德国 www.nord.com

Name plate example C3D

### 3.6.2 Standards to be observed during operation and maintenance



#### **WARNING**

#### **Danger to persons**

The motors must be disconnected from the mains before opening the terminal box.



#### **WARNING**

#### **Explosion hazard**

Opening the terminal box in an explosive atmosphere is prohibited.

Installation, use, parametrisation and maintenance of explosion-protected NORD CCEx motors must be performed by the operator in accordance with the operating and maintenance instructions B1091 and B1091-1 and in accordance with the following Chinese standards.

- GB 3836.13-2013 Explosive atmosphere - Part 13: Repair, overhaul, maintenance and changes of equipment  
(GB 3836.13-2013 爆炸性环境第 13 部分: 设备的修理、检修、修复和改造)
- GB/T 3836.15-2017 Explosive atmosphere - Part 15: Design, selection and installation of electrical devices  
(GB/T 3836.15-2017 爆炸性环境第 15 部分: 电气装置的设计、选型和安装)
- GB/T 3836.16-2017 Explosive atmosphere - Part 16: Inspection and maintenance of electrical devices  
(GB/T 3836.16-2017 爆炸性环境第 16 部分: 电气装置的检查与维护)
- GB 50257-2014 Design specifications and acceptance of electrical installations for explosion hazard and flammable environments.  
(GB 50257-2014 电气装置安装工程爆炸和火灾危险环境电气装置施工及验收规范)
- GB 15577-2018 Safety regulations for dust explosion protection  
(GB 15577-2018 粉尘防爆安全规程)

### 3.7 Explosion-protected electric motors according to Class I Div.2

#### **DANGER!**

#### **Explosion hazard**



All work must only be carried out with the machine at a standstill and the **power to the system switched off**.

Higher temperatures than the maximum permitted surface temperature of the housing may be present inside the motor. The motor must therefore never be opened in an explosive atmosphere!

Failure to comply with this may result in the ignition of an explosive atmosphere.

#### **WARNING**

#### **Explosion hazard**



Excessively heavy dust deposits must be avoided, as these impair the cooling of the device!

Impairment or obstruction of the flow of cooling air, for example due to partial or large area coverage of the fan cover or the entry of foreign bodies fall into the fan must be avoided in order to ensure adequate cooling.

Only cable glands and reducers which are approved for use in explosion hazard areas may be used.

All cable glands which are not used must be closed with blind screw plugs which are approved for potentially explosive areas.

Only the original seals may be used.

Failure to comply increases the risk of ignition of an explosive atmosphere.

#### **Further safety information**

“THIS EQUIPMENT IS SUITABLE FOR USE IN CLASS I DIVISION 2 GROUPS A,B,C,D/CLASS II DIVISION 2 GROUPS F & G”

#### **WARNING**



#### **EXPLOSION HAZARD**

DO NOT DISCONNECT EQUIPMENT UNLESS POWER HAS BEEN SWITCHED OFF OR THE AREA IS KNOWN TO BE NON-HAZARDOUS

#### **AVERTISSEMENT**



#### **RISQUE D'EXPLOSION**

AVANT DE DECONNECTER L'EQUIPEMENT, COUPER LE COURANT OU S'ASSURER QUE L'EMPLACEMENT EST DESIGNÉ 'NON DANGEREUX

#### **WARNING**



#### **EXPLOSION HAZARD**

SUBSTITUTION OF COMPONENTS MAY IMPAIR SUITABILITY FOR CLASS I DIV.2/CLASS II DIV.2

Electro~Motor.ir

**AVERTISSEMENT**



**RISQUE D'EXPLOSION**

LA SUBSTITUTION DE COMPOSANTS PEUT RENDRE CE MATERIEL INACCEPTABLE POUR LES EMPLACEMENTS DE CLASSE I DIVISION 2/ CLASSE II DIVISION 2

For these motors, the following information specifically or complementarily apply.

The motors are suitable for use in Class I Div.2 and may be used at an ambient temperature from -20 °C to +40 °C.

<b>Type suffix:</b>	<b>ID2</b>	e.g.:	80 LP/4 ID2 CUS TF
<b>Labelling:</b>			Class I Div.2 Group A, B, C, D with details of the temperature class

Explosive gas mixtures may cause severe or fatal injuries in combination with hot, electrically live and moving components of electrical machines.

The increased danger in explosion hazard areas requires especially strict observance of the general safety and commissioning information. It is necessary that the persons responsible are qualified according to national and local regulations.

These explosion-protected electrical machines comply with the standards CSA C.22.2 No. 100-14, CSA C22.2 No. 213-M1987 (R2013), UL Subject 1836, UL 1004-1.

The degree of explosion hazards determines the zone classification. The operator is responsible for the classification of the zones. The use of motors which are not certified for explosion hazard areas is prohibited in explosion hazard areas.

**3.7.1 Cable connections**

Cable glands must be certified and suitable for Class I Div 2. explosion hazard areas. Unused openings must be sealed with approved blind plugs.

For sizes 63 to 132, an isolated cable lug must be provided, if it is used to connect the earthing cable within the terminal box.

**3.7.2 Terminal box cover seals**

The terminal box cover gasket is captively mounted on the terminal box cover. Please only use an original seal when replacing the seal.

If the terminal box is opened during installation, maintenance, repair, troubleshooting or overhaul, the terminal box cover must be re-fitted after the work is complete. There must be no dirt on the surface of the seal or the sealing surface of the terminal box frame.

The screws for the terminal box cover must be tightened with a torque according to the list below.

	Tightening torques for terminal box cover screws				
	Thread diameter	M4	M5	M6	M8
	Tightening torque (Nm)	0.8 - 1.2	1.2 - 1.8	1.5 - 2.5	3.0 - 5.0

### 3.7.3 Electrical Connection

The electrical connections of the terminal board are protected against twisting. The voltage supply to the terminal board must be made by means of suitable ring terminals. The ring terminals are installed between the two brass washers below the lock washer. The nuts must be tightened with a torque according to the table below. The contact pressure is permanently maintained by means of the specified torque and the lock washer. In addition, twisting of the ring terminals of the voltage supply is prevented. The connection elements are corrosion-proof.

	Tightening torques for terminal board connections				
	Thread diameter	M4	M5	M6	M8
	Tightening torque (Nm)	0,8 - 1,2	1,8 - 2,5	2,7 - 4,0	5,5 - 8,0

#### Exploded diagram of electrical connection

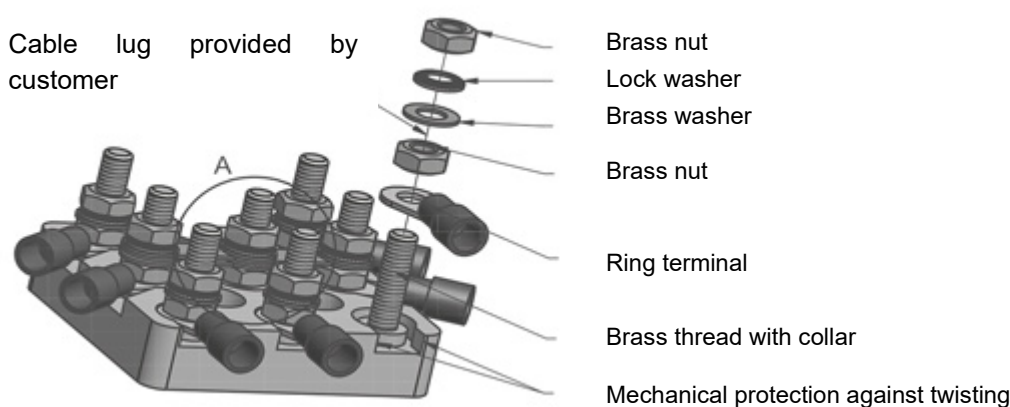

The motor must be grounded at one of the marked earthing terminals.

The use of aluminium connecting cables is not permissible.

Cables with a circular cross-section must be used with the supplied cable glands. The clamping nuts of the cable gland must be tightened to the torque specified in the following table.

	Tightening torques for lock nut						
	Cable gland	M20x1.5	M25x1.5	M32x1.5	M40x1.5	M50x1.5	M63x1.5
	Tightening torque (Nm)	3.0	6.0	12.0	14.0	20.0	25.0

When connecting, care must be taken that the permissible air gaps of at least 10 mm and the permissible leakage tracks of at least 12 mm between the electrically live components and components with the same potential as the housing, or between live components are maintained.

Check that the terminal nuts and the screw for the earth lead are tight before closing the terminal box. The terminal box seals and the cable gland seals must be correctly seated and must not be damaged.

### 3.7.4 Motor position – special features IM V3, IM V6

If the end of the shaft faces upwards, e.g. version IM V3, IM V6, a cover must be provided by the operator / installer, which prevents foreign bodies from falling into the fan cover of the motor (see EN IEC 60079-0:2018). This must not obstruct the fan from cooling the motor. If the end of the shaft faces downwards (AS, inclination 20° to 90°), e.g. versions IM V1, IM V5, the motors are to be used with a protective cover on the fan cover. For an inclination of less than 20°, an appropriate protective device, which meets the above mentioned conditions, must be provided by the operator / installer.







A hand wheel on the second shaft end is not permitted.



### 3.7.5 Further operating conditions

The motors are designed for continuous operation and normal one-time starting in which no significant starting heat is generated.

Voltage supply deviations are only permitted to a limited extent: Voltage  $\pm 5\%$ , frequency  $\pm 2\%$ . Mains symmetry must be maintained to keep heat generation within permissible limits. Significant deviations from the nominal values can lead to an impermissible increase in heat generation in the motor.

										08513530	
Type SK 100 LP/4 CUS ID2 TF						2019					
3 ~ Mot. No. 202592077-100						31261588					
INS F		NEMA IP 55		S1		AMB 40 °C		TEFC		DP	
60 Hz		230/460 V YY/Y		EFF IE3-90,0%		CODE L					
7,68/3,84 A		3,00 hp		2,20 kW		SF 1,15					
PF 0,79		1770r/min		Class I DIV2 Group A, B, C, D		Class II DIV2 Group F&G T3B-165°C					
Hz		r/min		Nm		lb-in		hp		A	
29 kg											
Over Temp Prot-2 Class F											
Getriebebau NORD GmbH & Co. KG, 22939 Bargteheide / GERMANY <a href="http://www.nord.com">www.nord.com</a>											

Each machine must be protected against impermissible heating by a current-dependent and delayed circuit breaker that has been tested for operation by an approved facility. If such a configuration is not possible, additional protection measures are required (e.g. thermal protection of the machine).

Repairs must be carried out by Getriebebau NORD or by an officially recognised expert. The work must be indicated with an additional repair plate. With the exception of standard, commercially available and equivalent components, only original spare parts (see spare parts list) may be used. This particularly applies for seals and connection parts.

Check that the connection terminals, protective conductor terminal and the equipotential bonding terminal are firmly fastened. Check that the cable glands and the terminal box seals are in good condition.

All work on electrical machinery must be performed when the machine is at a standstill and with all poles disconnected from the mains.

The motor must be removed for measurement of the insulation resistance. The measurement must not be performed in the explosion hazard area. As soon as measurement has been completed, discharge the connection terminals again immediately by short-circuiting in order to prevent any spark discharges occurring in the explosion hazard area.

Electro~Motor.ir

### 3.8 Explosion-protected electric motors according to Class II Div.2



#### DANGER!

#### Explosion hazard



All work must only be carried out with the machine at a standstill and the **power to the system switched off**.

Higher temperatures than the maximum permitted surface temperature of the housing may be present inside the motor. The motor must therefore never be opened in an explosive atmosphere!

Failure to comply with this may result in the ignition of an explosive atmosphere.



#### WARNING

#### Explosion hazard



Excessively heavy dust deposits must be avoided, as these impair the cooling of the device!

Impairment or obstruction of the flow of cooling air, for example due to partial or large area coverage of the fan cover or the entry of foreign bodies fall into the fan must be avoided in order to ensure adequate cooling.

Only cable glands and reducers which are approved for use in explosion hazard areas may be used.

All cable glands which are not used must be closed with blind screw plugs which are approved for potentially explosive areas.

Only the original seals may be used.

Failure to comply increases the risk of ignition of an explosive atmosphere.

#### Further safety information

“THIS EQUIPMENT IS SUITABLE FOR USE IN CLASS I DIVISION 2 GROUPS A,B,C,D/CLASS II DIVISION 2 GROUPS F & G”



#### WARNING



#### EXPLOSION HAZARD

DO NOT DISCONNECT EQUIPMENT UNLESS POWER HAS BEEN SWITCHED OFF OR THE AREA IS KNOWN TO BE NON-HAZARDOUS



#### AVERTISSEMENT



#### RISQUE D'EXPLOSION

AVANT DE DECONNECTER L'EQUIPEMENT, COUPER LE COURANT OU S'ASSURER QUE L'EMPLACEMENT EST DESIGNÉ 'NON DANGEREUX



#### WARNING



#### EXPLOSION HAZARD

SUBSTITUTION OF COMPONENTS MAY IMPAIR SUITABILITY FOR CLASS I DIV.2/CLASS II DIV.2

Electro~Motor.ir

**⚠ AVERTISSEMENT**



**RISQUE D'EXPLOSION**

LA SUBSTITUTION DE COMPOSANTS PEUT RENDRE CE MATERIEL INACCEPTABLE POUR LES EMPLACEMENTS DE CLASSE I DIVISION 2/ CLASSE II DIVISION 2

For these motors, the following information specifically or complementarily apply.

The motors are suitable for use in Class II Div.2 and may be used at an ambient temperature from - 20 °C to +40 °C.

<b>Type suffix:</b>	<b>IID2</b>	e.g.:	80 LP/4 IID2 CUS TF
<b>Labelling:</b>			Class II Div.2 Group F, G T3B 165°C

Explosive dust may cause severe or fatal injuries in combination with hot, electrically live and moving components of electrical machines.

The increased danger in explosion hazard areas requires especially strict observance of the general safety and commissioning information. It is necessary that the persons responsible are qualified according to national and local regulations.

It is necessary that the persons responsible for the use of these motors and frequency inverters in explosion hazard areas are trained in their correct use.

These explosion-protected electrical machines comply with the standards CSA C.22.2 N°25-1966, CSA C.22.2 N°100-14, UL Subject 1836, UL 1004-1 and are suitable for the Class II Div.2 area.

The degree of explosion hazards determines the zone classification. The operator is responsible for the classification of the zones. The use of motors which are not certified for explosion hazard areas is prohibited in explosion hazard areas.

**3.8.1 Terminal box cover seals**

The terminal box cover gasket is captively mounted on the terminal box cover. Please only use an original seal when replacing the seal.

If the terminal box is opened during installation, maintenance, repair, troubleshooting or overhaul, the terminal box cover must be re-fitted after the work is complete. There must be no dirt on the surface of the seal or the sealing surface of the terminal box frame.

The screws for the terminal box cover must be tightened with a torque according to the list below.

	Tightening torques for terminal box cover screws			
	Thread diameter	M4	M5	M6
Tightening torque (Nm)	0.8 - 1.2	1.2 - 1.8	1.5 - 2.5	3.0 - 5.0

### 3.8.2 Electrical Connection

The electrical connections of the terminal board are protected against twisting. The voltage supply to the terminal board must be made by means of suitable ring terminals. The ring terminals are installed between the two brass washers below the lock washer. The nuts must be tightened with a torque according to the table below. The contact pressure is permanently maintained by means of the specified torque and the lock washer. In addition, twisting of the ring terminals of the voltage supply is prevented. The connection elements are corrosion-proof.

	Tightening torques for terminal board connections				
	Thread diameter	M4	M5	M6	M8
	Tightening torque (Nm)	0,8 - 1,2	1,8 - 2,5	2,7 - 4,0	5,5 - 8,0

#### Exploded diagram of electrical connection

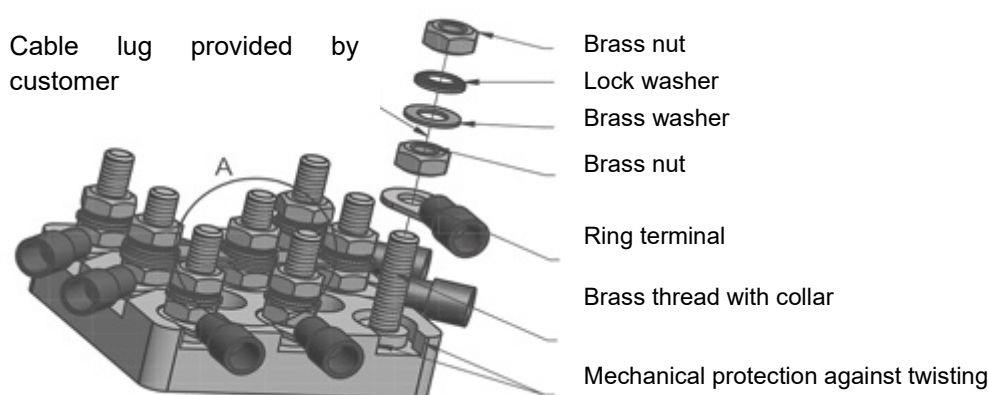

The motor must be grounded at one of the marked earthing terminals.

The use of aluminium connecting cables is not permissible.

Cables with a circular cross-section must be used with the supplied cable glands. The clamping nuts of the cable gland must be tightened to the torque specified in the following table.

	Tightening torques for lock nut						
	Cable gland	M20x1.5	M25x1.5	M32x1.5	M40x1.5	M50x1.5	M63x1.5
	Tightening torque (Nm)	3.0	6.0	12.0	14.0	20.0	25.0

When connecting, care must be taken that the permissible air gaps of at least 10 mm and the permissible leakage tracks of at least 12 mm between the electrically live components and components with the same potential as the housing, or between live components are maintained.

Check that the terminal nuts and the screw for the earth lead are tight before closing the terminal box. The terminal box seals and the cable gland seals must be correctly seated and must not be damaged.

### 3.8.3 Motor position – special features IM V3, IM V6

If the end of the shaft faces upwards, e.g. version IM V3, IM V6, a cover must be provided by the operator / installer, which prevents foreign bodies from falling into the fan cover of the motor (see EN IEC 60079-0:2018). This must not obstruct the fan from cooling the motor. If the end of the shaft faces downwards (AS, inclination 20° to 90°), e.g. versions IM V1, IM V5, the motors are to be used with a protective cover on the fan cover. For an inclination of less than 20°, an appropriate protective device, which meets the above mentioned conditions, must be provided by the operator / installer.

A hand wheel on the second shaft end is not permitted.

### 3.8.4 Cables and cable glands

For Class II Div. 2, the cable glands must as a minimum correspond to the protection type specified on the name plate. Unused openings must be sealed with blind plugs that comply with at least the protection class of the motor and zone.

The cable and blind plugs must be suitable for temperatures of at least 80 °C.

In order to connect cables or carry out other works, the motor must not be opened in explosive atmospheres. The voltage must always be switched off and secured against switch-on before opening.

The motors are equipped with threads for cable glands according to the following overview.

Assignment of cable gland to motor size														
Standard motor cable glands							Braking motor cable glands							
Type	Quantity	Threads	Quantity	Threads	Quantity	Threads	Quantity	Threads	Quantity	Threads	Quantity	Threads	Quantity	Threads
63	2	M20x1.5					4	M20x1.5	2	M12x1.5				
71	2	M20x1.5					4	M20x1.5	2	M12x1.5				
80	2	M25x1.5					4	M25x1.5	2	M12x1.5				
90	2	M25x1.5					4	M25x1.5	2	M12x1.5				
100	2	M32x1.5					4	M32x1.5	2	M12x1.5				
112	2	M32x1.5					4	M32x1.5	2	M12x1.5				
132	2	M32x1.5					4	M32x1.5	2	M12x1.5	2	M16x1.5		
160/ 180/..X	2	M40x1.5	2	M12x1.5	2	M16x1.5	2	M40x1.5	2	M12x1.5	2	M16x1.5		

### 3.8.5 Painting

The motors are equipped with a suitable, electrostatically tested painting ex-works. Subsequent painting may only be carried out in consultation with Getriebbau NORD or a repair workshop approved for the repair of explosion-protected electric motors. The valid standards and regulations must be observed.









### 3.8.6 IEC-B14 motors

Please comply with the information in Section 1.3.2. Otherwise, explosion protection is not ensured.

### 3.8.7 Further operating conditions

Unless otherwise specified on the rating plate for operating modes and tolerances, electric machines are designed for continuous operation and normal infrequent starting where insignificant start-up heating occurs. The motors may only be used for the type of operation stated on the name plate.

The installation instructions must be observed.

												08513630	
Type SK 132 SP/4 CUS IID2 TF 2019													
3 ~ Mot. No. 202608811-400						31273965							
INS F		NEMA IP55		S1		AMB 40 °C		TEFC		DP			
60 Hz		230/460 V YY/Y		EFF IE3-91,7%		CODEM							
		19,5/ 9,75 A		7,50 hp		5,50 kW		SF 1,15					
PF 0,77		1770 r/min											
INVERTER DUTY VPWM CT						Class II DIV2 Group F&G T3B-165°C							
Hz		r/min		Nm		lb-in		hp		A			
12		350		30,50		270,10		1,50		19,8/9,90			
60		1750		30,50		270,10		7,50		19,8/9,90			
57 kg		MB 20 Nm		230 VAC		205 VDC							
Over Temp Prot-2 Class F													
Getriebebau NORD GmbH & Co. KG, 22939 Bargteheide / GERMANY										www.nord.com			

The motors are self-cooled. Radial shaft seals are mounted both on the drive and ventilation side. The motors are manufactured with protection class IP55, optionally IP66. Under normal operation conditions, the surface temperature does not exceed the surface temperature indicated on the name plate.

### 3.8.8 Minimum cross section of bonding conductors

Cross section of the phase conductor of the installation S [mm <sup>2</sup> ]	Minimum cross section of the associated protective conductor S <sub>p</sub> [mm <sup>2</sup> ]
S ≤ 16	S
16 < S ≤ 35	16
S > 35	0.5 S

The minimum cross-section for connection of a cable to the outer earthing terminal is 4 mm<sup>2</sup>.

### 3.8.9 Operation with frequency inverters

NORD motors that comply with Class II Div.2 are suitable for operation on a frequency inverter. The variable speed range requires temperature monitoring using temperature sensors. The approved speed ranges can be found in the following table:

Motor type	Type VR 5:1			Type VN 10:1			Type VW 20:1		
	M	$n_{max}$	$n_{min}$	M	$n_{max}$	$n_{min}$	M	$n_{max}$	$n_{min}$
	[Nm]	[r/min]	[r/min]	[Nm]	[r/min]	[r/min]	[Nm]	[r/min]	[r/min]
SK 80 LP/4	4.32	1680	350	3.16	1800	175	2.98	2400	110
SK 90 SP/4	6.10	1750	355	3.96	1800	185	4.45	2400	80
SK 90 LP/4	8.63	1695	360	6.28	1800	115	6.32	2400	110
SK 100 LP/4	12.50	1700	315	8.19	1800	100	9.25	2400	65
SK 112 MP/4	20.30	1750	360	11.87	1800	180	14.84	2400	115
SK 132 SP/4	30.50	1750	350	19.78	1800	185	22.25	2400	120
SK 132 MP/4	41.00	1745	350	29.67	1800	175	29.67	2400	125
SK 160 MP/4	60.30	1760	345	39.56	1800	175	44.51	2400	120
SK 160 LP/4	80.70	1760	350	59.34	1800	180	59.34	2400	115
SK 180 MP/4	100.60	1760	355	79.12	1800	180	74.18	2400	125
SK 180 LP/4	121.00	1765	350	98.90	1800	175	89.01	2400	120

If the frequency inverter is not approved for operation within the specified explosion hazard zone, the frequency inverter is to be installed outside the explosion hazard area.

### 3.8.10 Maintenance

**The voltage must always be switched off and secured against switch-on before opening.**

**Notice! Temperatures may occur within the motor that are higher than the maximum permissible surface temperature of the housing. The motor must therefore not be opened in an explosive dust atmosphere. The motors must be checked and tested for functional safety on a regular basis. The valid national standards and regulations must be observed.**

Impermissibly high dust deposits > 5 mm are to be avoided. The motor must not be further operated if functional safety is not guaranteed. Upon replacement of the ball bearings, the radial shaft seals must also be replaced. Please use the radial shaft seals prescribed by Getriebebau NORD. It is essential to pay attention to professional installation. The radial shaft seal's outer ring and sealing lip must be lubricated. If an explosion-protected gear unit is flanged to the motor in a dust-proof manner, a NBR radial shaft seal may be used on the motor's A side if the gear oil temperature does not exceed 85°C. Only original parts may be used as spare parts, except for standardised, customary and equivalent parts. This is particularly valid for seals and connection parts. In case of terminal box parts or spare parts for outer earthing, the parts must be ordered according to the spare parts list of the operating instructions.

Seals, radial shaft seals and cable glands must be checked for functionality on a regular basis.

**The maintenance of the motor's dust protection is of outstanding importance for explosion protection.** Maintenance must be carried out by qualified personnel in a specialist workshop with appropriate equipment. We urgently recommend that the general overhaul is carried out by the NORD Service department.







## **4 Replacement parts**

Please note our spare parts catalogue PL 1090 under [www.nord.com](http://www.nord.com).

We will be pleased to send you the spare parts catalogue on request.

Electro~Motor.ir

## 5 Declarations of Conformity

	
<h1>GETRIEBEBAU NORD</h1> <p>Member of the NORD DRIVESYSTEMS Group</p>	
<p><b>Getriebebau NORD GmbH &amp; Co. KG</b>          Getriebebau-Nord-Str. 1 . 22941 Bargteheide, Germany . Fon. +49(0)4532 289 - 0 . Fax +49(0)4532 289 - 2253 . info@nord.com</p>	
<h3>EC/EU Declaration of Conformity</h3> <p>In the meaning of the directive 2014/34/EU Annex VII, 2014/30/EU Annex II, 2009/125/EG Annex IV and 2011/65/EU Annex VI</p>	
C411000_3021	
<p>Getriebebau NORD GmbH &amp; Co. KG as manufacturer in sole responsibility hereby declares, <span style="float: right;">Page 1 of 1</span>          that the three-phase asynchronous motors from the product series</p>	
<ul style="list-style-type: none"> <li>• <b>SK 63<sup>*1</sup>/<sup>*2</sup> 2D <sup>*3</sup> to SK 200<sup>*1</sup>/<sup>*2</sup> 2D <sup>*3</sup></b> <ul style="list-style-type: none"> <li><sup>1</sup>) Power code: S, SA, SX, M, MA, MB, MX, L, LA, LB, LX, R, X, Y, A, W -optionally supplemented by: H, P</li> <li><sup>2</sup>) Number of poles: 2, 4, 6</li> <li><sup>3</sup>) Additional options</li> </ul> </li> </ul>	
<p>with ATEX labeling  <b>II 2D Ex tb IIIC T . . . °C Db</b></p>	
<p>comply with the following regulations:</p>	
<b>ATEX Directive for products</b>	<b>2014/34/EU</b>
<b>Eco-design Directive</b>	<b>2009/125/EG (VO No. 2019/1781)</b>
<b>EMC Directive</b>	<b>2014/30/EU</b>
<b>RoHS Directive</b>	<b>2011/65/EU</b>
<b>Delegated Directive (EU)</b>	<b>2015/863</b>
	<b>OJ. L 096 of 29<sup>th</sup> March 2014, S. 309–356</b>
	<b>OJ. L 285 of 31<sup>th</sup> October 2009, S. 10–35</b>
	<b>OJ. L 96 of 29<sup>th</sup> March 2014, S. 79–106</b>
	<b>OJ. L 174 of 1<sup>th</sup> July 2011, S. 88–110</b>
	<b>OJ. L137 of 4<sup>th</sup> June 2015, S. 10-12</b>
<p><b>Applied standards:</b></p>	
EN 60079-0:2018	EN 60079-31:2014
EN 60034-1:2010+AC:2010	EN 60034-2-1:2014
EN 60034-6:1993	EN 60034-7:1993+A1:2001
EN 60034-9:2005+A1:2007	EN 60034-11:2004
EN 60034-30-1:2014	EN 55011:2016+A1:2017
EN 61000-6-4:2007+A1:2011	EN 60204-1:2018
	EN 60529:1991+A1:2000+A2:2013+AC2016-12
	EN 60034-5:2001+A1:2007
	EN 60034-8:2007+A1:2014
	EN 60034-14:2018
	EN 61000-6-3:2007+A1:2011+AC:2012
	EN IEC 63000:2018
<p><b>EU-Type-Examination Certificates: BVS 04 ATEX E 037</b></p>	
<p><b>Notified body for the assessment of the quality management system:</b></p>	
Physikalisch-Technische Bundesanstalt (PTB)	Bundesallee 100
Identity number: 0102	38116 Braunschweig
<p><b>Notified body to issue for the EU-Type-Examination Certificate:</b></p>	
DEKRA EXAM GmbH	Dinnendahlstraße 9
Identity number: 0158	44809 Bochum
<p>First marking was carried out in 2004.</p>	
<p><b>Bargteheide, 1st July 2021</b></p>	
 U. Küchenmeister Managing Director	 Dr. O. Sadi Technical Director

# Electro~Motor.ir

# GETRIEBEBAU NORD

Member of the NORD DRIVESYSTEMS Group



---

**Getriebebau NORD GmbH & Co. KG**  
 Getriebebau-Nord-Str. 1 · 22941 Bargteheide, Germany · Fon. +49(0)4532 289 - 0 · Fax +49(0)4532 289 - 2253 · info@nord.com

---

## EC/EU Declaration of Conformity

In the meaning of the directive 2014/34/EU Annex VIII, 2014/30/EU Annex II, 2009/125/EG Annex IV and 2011/65/EU Annex VI

C412000\_3021

---

Getriebebau NORD GmbH & Co. KG as manufacturer in sole responsibility hereby declares,  
that the three-phase asynchronous motors from the product series

Page 1 of 1

- **SK 63<sup>\*1)/\*\*2) 3D \*3)</sup> to **SK 250<sup>\*1)/\*\*2) 3D \*3)</sup>****

<sup>1)</sup> Power code: S, SA, SX, M, MA, MB, MX, L, LA, LB, LX, R, X, Y, A, W -optionally supplemented by: H, P  
<sup>2)</sup> Number of poles: 2, 4, 6  
<sup>3)</sup> Additional options

with ATEX labeling  II 3D Ex tc IIIB T . . . °C Dc

comply with the following regulations:

<b>ATEX Directive for products</b>	<b>2014/34/EU</b>	<b>OJ. L 096 of 29<sup>th</sup> March 2014, S. 309–356</b>
<b>Eco-design Directive</b>	<b>2009/125/EG (VO No. 2019/1781)</b>	<b>OJ. L 285 of 31<sup>th</sup> October 2009, S. 10–35</b>
<b>EMC Directive</b>	<b>2014/30/EU</b>	<b>OJ. L 96 of 29<sup>th</sup> March 2014, S. 79–106</b>
<b>RoHS Directive</b>	<b>2011/65/EU</b>	<b>OJ. L 174 of 1<sup>th</sup> July 2011, S. 88–110</b>
<b>Delegated Directive (EU)</b>	<b>2015/863</b>	<b>OJ. L137 of 4<sup>th</sup> June 2015, S. 10-12</b>

**Applied standards:**

EN 60079-0:2018	EN 60079-31:2014	EN 60529:1991+A1:2000+A2:2013+AC2016-12
EN 60034-1:2010+AC:2010	EN 60034-2-1:2014	EN 60034-5:2001+A1:2007
EN 60034-6:1993	EN 60034-7:1993+A1:2001	EN 60034-8:2007+A1:2014
EN 60034-9:2005+A1:2007	EN 60034-11:2004	EN 60034-14:2018
EN 60034-30-1:2014	EN 55011:2016+A1:2017	EN 61000-6-3:2007+A1:2011+AC:2012
EN 61000-6-4:2007+A1:2011	EN 60204-1:2018	EN IEC 63000:2018

First marking was carried out in 2011.

**Bargteheide, 1st July 2021**

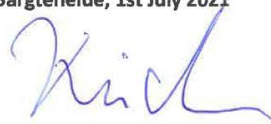

U. Küchenmeister  
Managing Director



Dr. O. Sadi  
Technical Director



## GETRIEBEBAU NORD

Member of the NORD DRIVESYSTEMS Group

---

**Getriebebau NORD GmbH & Co. KG**  
 Getriebebau-Nord-Str. 1 22941 Bargteheide, Germany · Fon. +49(0)4532 289 - 0. Fax +49(0)4532 289 - 2253. [info@nord.com](mailto:info@nord.com) C411000\_3021

### EC/EU Declaration of Conformity

In the meaning of the directive 2014/34/EU Annex VII und 2014/30/EU Annex II, 2009/125/EC Annex IV, 2011/65/EU Annex VI

---

Getriebebau NORD GmbH & Co. KG as manufacturer hereby declares, Page 1 of 1  
 that the three-phase asynchronous motors from the product series

- **SK 63<sup>\*1)</sup>/<sup>\*2)</sup> 2G<sup>\*3)</sup> to SK 200<sup>\*1)</sup>/<sup>\*2)</sup> 2G<sup>\*3)</sup>**

<sup>1)</sup> Power code: S, SA, SX, M, MA, MB, MX, L, LA, LB, LX, R, X, Y, A, W -optionally supplemented by: H, P  
<sup>2)</sup> Number of poles: 2, 4, 6  
<sup>3)</sup> Additional options

with ATEX labeling  II 2G Ex eb IIC T3 Gb

comply with the following regulation

<b>ATEX Directive for products</b>	<b>2014/34/EU</b>	<b>OJ. L 096 of 29<sup>th</sup> March 2014, S. 309–356</b>
<b>Eco-design Directive</b>	<b>2009/125/EG (VO No. 2019/1781)</b>	<b>OJ. L 285 of 31<sup>th</sup> October 2009, S. 10–35</b>
<b>EMC-Directive</b>	<b>2014/30/EU (ab 20. April 2016)</b>	<b>OJ. L 96 of 29<sup>th</sup> March 2014, S. 79–106</b>
<b>RoHS-Directive</b>	<b>2011/65/EU</b>	<b>OJ. L 174 of 1<sup>st</sup> July 2011, S. 88–110</b>
<b>Delegated Directive (EU)</b>	<b>2015/863</b>	<b>OJ. L137 of 4<sup>th</sup> June 2015, S. 10-12</b>

**Applied standards:**

EN 60079-0:2018	EN IEC 60079-7: 2015/ A1: 2018	EN 60529:1991+A1:2000+A2:2013+AC2016-12
EN 60034-1:2010+AC:2010	EN 60034-2-1:2014	EN 60034-5:2001+A1:2007
EN 60034-6:1993	EN 60034-7:1993+A1:2001	EN 60034-8:2007+A1:2014
EN 60034-9:2005+A1:2007	EN 60034-11:2004	EN 60034-14:2018
EN 60034-30-1:2014	EN 55011:2016+A1:2017	EN 61000-6-3:2007+A1:2011+AC:2012
EN 61000-6-4:2007+A1:2011	EN 60204-1:2018	EN IEC 63000:2018

**EC-Type-Examination Certificates:**  
 PTB 14 ATEX 3030, PTB 14 ATEX 3032, PTB 08 ATEX 3024-2, PTB 14 ATEX 3034,  
 PTB 14 ATEX 3036, PTB 14 ATEX 3038, PTB 14 ATEX 3040, PTB 14 ATEX 3042  
 PTB 14 ATEX 3044, PTB 14 ATEX 3046

**Notified body for the assessment of the quality management system:**  
 Physikalisch-Technische Bundesanstalt (PTB) Bundesallee 100  
 Identity number: 0102 38116 Braunschweig

**Notified body to issue for the EC-Type-Examination Certificate:**  
 Physikalisch-Technische Bundesanstalt (PTB) Bundesallee 100  
 Identity number: 0102 38116 Braunschweig

First marking was carried out in 2008.

**Bargteheide, 1st July 2021**

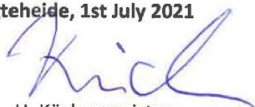

U. Küchenmeister  
Managing Director



Dr. O. Sadi  
Technical Director

# GETRIEBEBAU NORD

Member of the NORD DRIVESYSTEMS Group



---

**Getriebebau NORD GmbH & Co. KG**  
 Getriebebau-Nord-Str. 1 . 22941 Bargteheide, Germany . Fon. +49(0)4532 289 - 0 . Fax +49(0)4532 289 - 2253 . [info@nord.com](mailto:info@nord.com) C412000\_3021

---

## EC/EU Declaration of Conformity

In the meaning of the directive 2014/34/EU Annex VIII und 2014/30/EU Annex II, 2009/125/EC Annex IV, 2011/65/EU Annex VI

---

Getriebebau NORD GmbH & Co. KG as manufacturer hereby declares,  
that the three-phase asynchronous motors from the product series

Page 1 of 1

- **SK 63<sup>\*1</sup>/<sup>\*2</sup> 3G<sup>\*3</sup> to SK 200<sup>\*1</sup>/<sup>\*2</sup> 3G<sup>\*3</sup>**
  - <sup>1)</sup> Power code: S, SA, SX, M, MA, MB, MX, L, LA, LB, LX, R, X, Y, A, W -optionally supplemented by: H, P
  - <sup>2)</sup> Number of poles: 2, 4, 6
  - <sup>3)</sup> Additional options

with ATEX labeling II 3G Ex ec IIC T3 Gc

comply with the following regulations:

<b>ATEX Directive for products</b>	2014/34/EU	OJ. L 096 of 29 <sup>th</sup> March 2014, S. 309–356
<b>Eco-design Directive</b>	2009/125/EG (VO No. 2019/1781)	OJ. L 285 of 31 <sup>th</sup> October 2009, S. 10–35
<b>EMC-Directive</b>	2014/30/EU (ab 20. April 2016)	OJ. L 96 of 29 <sup>th</sup> March 2014, S. 79–106
<b>RoHS-Directive</b>	2011/65/EU	OJ. L 174 of 1 <sup>st</sup> July 2011, S. 88–110
<b>Delegated Directive (EU)</b>	2015/863	OJ. L137 of 4 <sup>th</sup> June 2015, S. 10-12

**Applied standards:**

EN 60079-0:2018	EN IEC 60079-7:2015/ A1:2018	EN 60529:1991+A1:2000+A2:2013+AC2016-12
EN 60034-1:2010+AC:2010	EN 60034-2-1:2014	EN 60034-5:2001+A1:2007
EN 60034-6:1993	EN 60034-7:1993+A1:2001	EN 60034-8:2007+A1:2014
EN 60034-9:2005+A1:2007	EN 60034-11:2004	EN 60034-14:2018
EN 60034-30-1:2014	EN 55011:2016+A1:2017	EN 61000-6-3:2007+A1:2011+AC:2012
EN 61000-6-4:2007+A1:2011	EN 60204-1:2018	EN IEC 63000:2018

First marking was carried out in 2014.





**Bargteheide, 1st July 2021**

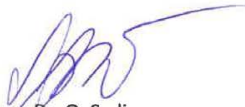

U. Küchenmeister  
Managing Director

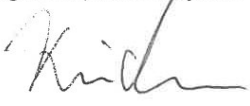

Dr. O. Sadi  
Technical Director

<b>GETRIEBEBAU NORD</b> Member of the NORD DRIVESYSTEMS Group		
<b>Getriebebau NORD GmbH &amp; Co. KG</b> Getriebebau-Nord-Str. 1 . 22941 Bargteheide, Germany . Fon. +49(0)4532 289 - 0 . Fax +49(0)4532 289 - 2253 . info@nord.com		
<b>UK Declaration of Conformity</b> in accordance with the UK Statutory Instruments listed below		
Getriebebau NORD GmbH & Co. KG as manufacturer in sole responsibility hereby declares, that the three-phase asynchronous motors from the product series		C230102 Page 1 of 1
SK 63 <sup>*1/*2</sup> 3D <sup>*3</sup> to SK 250 <sup>*1/*2</sup> 3D <sup>*3</sup>		
1) Power code: S, SA, SX, M, MA, MB, MX, L, LA, LB, LX, R, X, Y, A, W -optionally supplemented by: H, P 2) Number of poles: 2, 4, 6 3) Additional options with labeling  II 3D Ex tc IIIB T . . . °C Dc		
comply with the following, as amended, <b>UK Statutory Instruments</b> :		
<b>Title</b>	<b>Years and Numbers</b>	
The Equipment and Protective Systems Intended for Use in Potentially Explosive Atmospheres Regulations 2016	2016 No. 1107	
The Ecodesign for Energy-Related Products and Energy Information (Amendment) (EU Exit) Regulations 2020	2020 No. 1528	
The Electromagnetic Compatibility Regulations 2016	2016 No. 1091	
The Restriction of the Use of Certain Hazardous Substances in Electrical and Electronic Equipment Regulations 2012	2012 No. 3032	
Standards applied:		
EN 60079-0:2018	EN 60079-31:2014	EN 60529:1991+A1:2000+A2:2013+AC2016-12
EN 60034-1:2010+AC:2010	EN 60034-2-1:2014	EN 60034-5:2001+A1:2007
EN 60034-6:1993	EN 60034-7:1993+A1:2001	EN 60034-8:2007+A1:2014
EN 60034-9:2005+A1:2007	EN 60034-11:2004	EN 60034-14:2018
EN 60034-30-1:2014	EN 55011:2016+A1:2017	EN 61000-6-3:2007+A1:2011+AC:2012
EN 61000-6-4:2007+A1:2011	EN 60204-1:2018	EN IEC 63000:2018
<b>Bargteheide, 3rd January 2022</b>		
 U. Küchenmeister Managing Director	 Dr. O. Sadi Technical Director	

# Electro~Motor.ir

Electro~Motor.ir

Headquarters  
Getriebebau NORD GmbH & Co. KG  
Getriebebau-Nord-Str. 1  
22941 Bargteheide, Deutschland  
T: +49 45 32 / 289 0  
F: +49 45 32 / 289 22 53  
info@nord.com

Electro~Motor.ir

6051302 / 2722